**F3G
Fusion**

Option 



**Dolby[®] Digital[™] / Digital Plus[™]
Encoder Option (+ENCDA ... ENCDD)**

Manual Supplement



Cobalt Digital Inc.

2406 E. University Ave.
Urbana, IL 61802
Voice 217.344.1243 • Fax 217.344.1245
www.cobaltdigital.com

Copyright

©Copyright 2011, Cobalt Digital Inc. All Rights Reserved.

Duplication or distribution of this manual and any information contained within is strictly prohibited without the express written permission of Cobalt Digital Inc. This manual and any information contained within, may not be reproduced, distributed, or transmitted in any form, or by any means, for any purpose, without the express written permission of Cobalt Digital Inc. Reproduction or reverse engineering of software used in this device is prohibited.

Disclaimer

The information in this document has been carefully examined and is believed to be entirely reliable. However, no responsibility is assumed for inaccuracies. Furthermore, Cobalt Digital Inc. reserves the right to make changes to any products herein to improve readability, function, or design. Cobalt Digital Inc. does not assume any liability arising out of the application or use of any product or circuit described herein. **This manual is a supplement and is incomplete unless used with an Owner's or Product Manual. Refer to the applicable Product Manual for complete personnel protection and equipment safety information.**

Trademark Information

Cobalt[®] is a registered trademark of Cobalt Digital Inc.

FUSION3G[®] is a registered trademark of Cobalt Digital Inc. **COMPASS**[™] is a trademark of Cobalt Digital Inc.

openGear[®] is a registered trademark of Ross Video Limited. **DashBoard**[™] is a trademark of Ross Video Limited. Dolby[®] encoder technology on this card is manufactured under license from Dolby Laboratories. **Dolby**[®] is a registered trademark of Dolby Laboratories, Inc. Other product names or trademarks appearing in this manual are the property of their respective owners.

Linear Acoustic[®] is a registered trademark of Linear Acoustic Inc. 2.0-to-5.1 audio upmixer licensed feature uses the **AutoMAX-II**[™] upmix algorithm provided under license from Linear Acoustic Inc. Loudness processor licensed feature uses **AEROMAX**[™] algorithms provided under license from Linear Acoustic Inc. **Linear Acoustic**, the "LA" symbol, **UPMAX**, **AutoMAX**, **AutoMAX-II**, and **AEROMAX** are trademarks of Linear Acoustic Inc. All Rights Reserved.

Manual No.:	OPT-SW-F3GENCD-MS
Document	
Version:	1.0
Release Date:	June 8, 2011

Overview

This manual supplement provides descriptions and operating instruction for the **+ENC D** (Dolby® Encode) Option available as an option on new Cobalt® FUSION3G® (9900-Series) cards, and as a purchased field-installed licensable feature upload.

- Note:**
- This option can be ordered to provide up to four independent Dolby® Digital/ Digital Plus™ encoders per card (ordered as **+ENCDA** thru **+ENCDD**). See the table below for basic configuration information and important considerations.
 - In this document, “5.1” and “2.0” informally refers to Dolby AC-3/Digital Plus modes 3/2L and 2/0, respectively.

Dolby® Digital Modes Accommodation

Description	+ENCDA	+ENCDB	+ENCDC	+ENCDD
Dual 5.1	5.1	5.1	—	—
5.1 + 2.0 + 2.0	5.1	—	2.0	2.0
Dual 5.1 + 2.0	5.1	5.1	2.0	—
Quad 2.0	2.0	2.0	2.0	2.0

Dolby® Digital Plus™ Modes Accommodation

	+ENCDA	+ENCDB	+ENCDC	+ENCDD
5.1	5.1	—	—	—
Dual 2.0	—	—	2.0	2.0

- Note:**
1. Encoding modes shown above represent greatest channel count for a given encoder. All encoders can be set for lower modes as desired (examples: any listing above indicating “5.1” can be set for “2.0”; any listing above indicating “2.0” can be set for “1.0”).
 2. Unshaded cells above indicate allowable modes specified for proper unrestricted operation. Shaded cells indicate combinations which may not produce encoded pairs in all instances. This is a function of available processing resources and is influenced by selected bit rates and program material complexity. In the event selected encoding is not available, the encoder displays a message to that effect. This is described in further detail in the operating section that follows.
 3. Encoders **ENCDA** and **ENCDB** are full encoders, and can be set for any of several Dolby encoding modes. Encoders **ENCDC** and **ENCDD** are limited to 2.0 (or lower) encoding.

+ENCD Option Functional Description

(See Figure 1.) The Dolby® encoders receive up to six audio channels (ENCDC, ENCDL stereo only) from the internal bus and/or optional audio DSP (upmixed and/or loudness-processed) channels and produces up to four discrete encoded Dolby® pairs. Individual internally generated metadata can be user-defined using the encoder controls, or external metadata from SMPTE 2020, serial, or optional on-card Dolby decoder can be used. Each encoder can be set to use its own individually defined internal metadata, or use global external metadata. The encoded pair can be sent from the card as embedded audio or over discrete AES-3id connections as a SMPTE 337M-formatted non-PCM signal.

Note: The Dolby® encoders can receive PCM audio inputs from any combination of internal bus or Audio DSP outputs. The resulting encoded pairs can be sent only to embedded or AES card audio outputs.

Input Audio Mapping. Any audio input supported by the card can serve as audio inputs for the Dolby® encoders. The encoder selects from these sources which can be user mapped to encoder inputs **Dolby 1** thru **Dolby 6**.

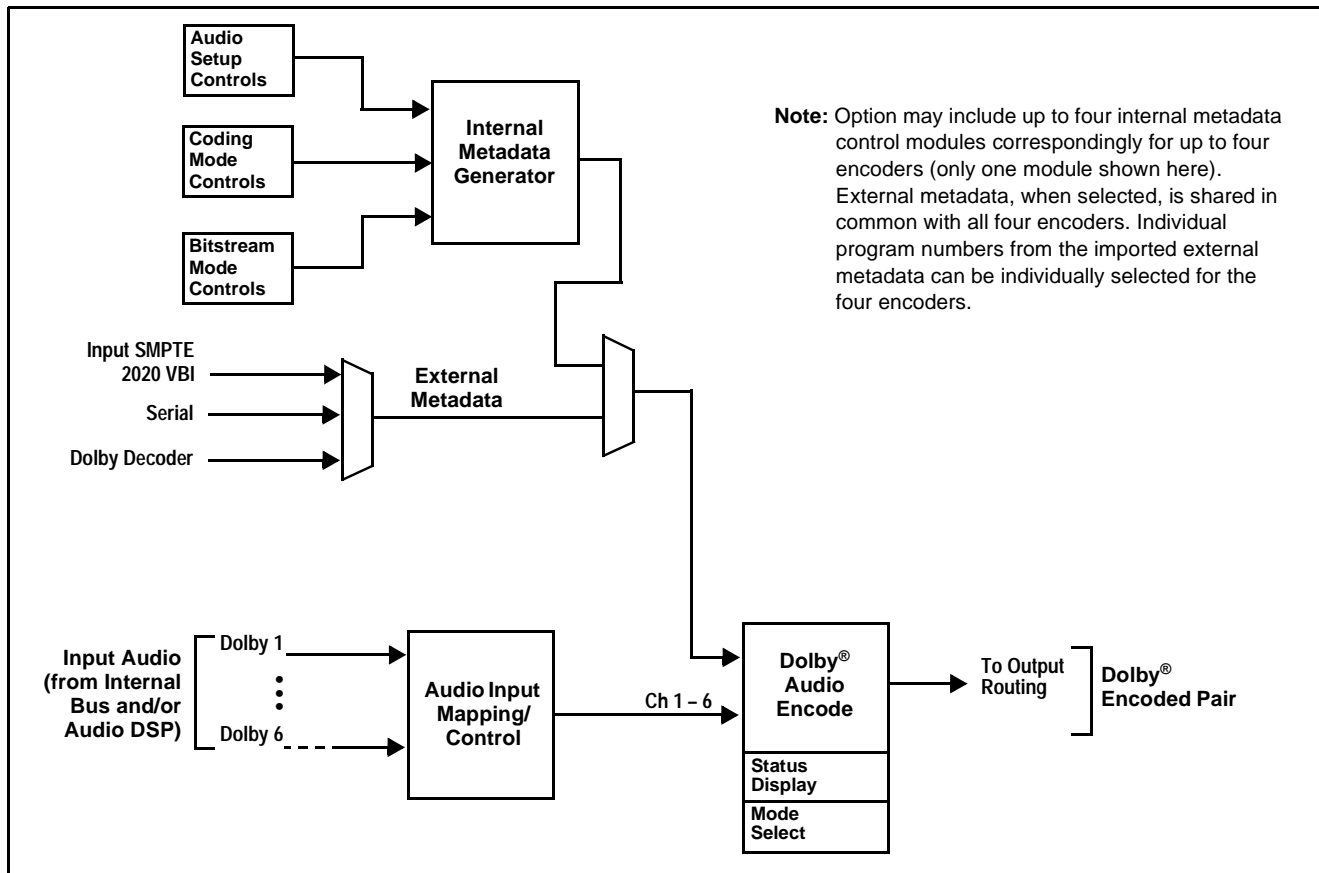

Figure 1 Dolby® Encoder Functional Block Diagram

Internal Metadata Generator. The internal metadata generator provides full audio setup, program coding, and bitstream definition controls, allowing user-generated metadata for providing Dolby® encoding without any external metadata being required.

Full audio production controls are provided in general conformance with ATSC A/52B definitions.

Dolby® Audio Encode. In accordance with the selected metadata, the Dolby® audio encode function receives the audio inputs **Dolby 1-6** from the internal bus and/or Audio DSP and provides the Dolby® encoded SMPTE 337M pair. The encoded pairs are available as a source for an embedded channel pairs, and as sources for AES output pairs (allowing the encoded pair to be available over a discrete AES-3id port).

The encoded AC-3 data rate can be selected from multiple choices with associated audio quality trade-offs.

Uploading Option Feature (Field Upgrade Only)

- Note:**
- If your FUSION3G[®] card was purchased with the option(s) covered here, this procedure is not required for your card. If you have purchased this feature to be field-installed on an existing card, perform the upload procedure here to upload the feature key file sent by Cobalt, and to activate the feature on your card.
 - To order features and obtain a license key, contact Cobalt[®] sales at sales@cobaltdigital.com or at the contact information on the cover of this supplement. Please provide the Serial Number of your card (displayed in the Card Info pane) when contacting us for your feature key. Typically, a feature key file is bound to the card's serial number and will only work with that card. Please indicate if upgrades are needed for more than one card.

Activate licensable feature as described below.

1. Cobalt typically supplies a .bin file (by e-mail; file size < 10kB) that activates the licensable feature. Download this file to a convenient location on the PC connected to the card's frame.

Note: During this procedure, the card will go offline while the feature is installed. Make certain card is not carrying OTA signal.

2. In DashBoard for the card being upgraded click the **Upload** button and browse to the feature license file (in the example below, license_cobalt_SN315909_9901-UDX.bin).

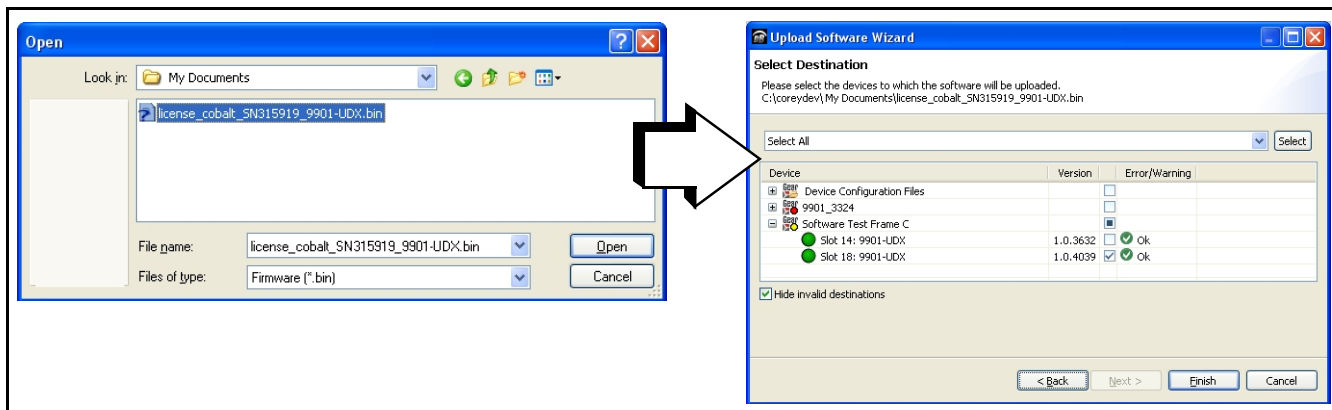

3. Select the file, click **Open** and then follow the prompts. With intended card selected ("Slot 18 UDX-9901" in example above), click **Finish**. When the card comes back online, the feature appears in the DashBoard controls and is ready for use.

Note: Applying the licensable feature has no effect on prior settings. All control settings and drop-down selections are retained.

Note: Added features, when first appearing after installation, are set to their factory default states. For features having a direct impact on the output signal, all controls are initially set to disabled or null.

Dolby Encoder Controls and Examples

Table 1 individually lists and describes Dolby encoder controls available using DashBoard™ for cards equipped with the +ENCD option.

Table 1 +ENCD Option Control List and Descriptions

	<p>Encoder sub-tab provides global setup and status monitoring for the up to four Dolby encoders.</p>
<p>Encoder Global Controls – The following controls are used as a group control for all encoders.</p>	
<p>• Encoding Mode</p>	<p>Selects the encoding modes for the up to four encoders as shown below.</p>
<div data-bbox="267 856 1079 1165">  </div> <p>Note: The drop-down allows the maximum combination of encoding choices available. Choices shown in this example depict full +ENCDA thru +ENCDD licensing (as further example, a license for only +ENCDA and +ENCDB will only show choices related to encoders A and B). Also see the Note on page 1 regarding important restrictions.</p>	
<p>• External Metadata Select</p> <div data-bbox="235 1344 706 1669">  </div>	<p>When external metadata is to be used, Dolby DSP Metadata Source selects the external metadata source used by the encoders from the choices shown.</p> <p>Note:</p> <ul style="list-style-type: none"> • This control also appears on the Metadata Routing and Embedding tab and is mutually ganged with selections performed on either tab. If external metadata is to be used, also set other controls on the Metadata Routing and Embedding tab as intended. • If internal metadata is to be used, setting this control is not required. <p>Accepts or rejects external metadata marked as “0 frame rate”. When set for Reject and metadata is received without compatible frame rate, external metadata is blocked.</p> <p>Note: For typical use, this control should always be set to the default Reject setting.</p>

Table 1 +ENCD Option Control List and Descriptions — continued

		<p>(continued)</p>
<p>Encoder Inputs Internal Metadata</p>		
<p>• Dolby DSP Status/Reset Controls</p>		
		<p>Provides reboot (restart) and encoding status displays. Where an encoder error display is present, also indicates global encoder error.</p> <p>Note:</p> <ul style="list-style-type: none"> • Encoding errors are typically caused by setting the encoders to conditions not specifically authorized, resulting in encoding complexity exceeding DSP capacity (see Note on pg. 1). Note that Dolby Digital Plus, while resulting in a more efficient data stream, typically requires greater processing capacity. • Encoding errors are also displayed on the card's Card Info pane and overall DashBoard card status indicator (indicator changes from green to red).
<p>• Encoding Info and Status Display</p>		<p>Displays encoding status summary for up to four encoders.</p> <ul style="list-style-type: none"> • Example below shows all four encoders properly encoding as per selected encoding. • Installed encoders that are not enabled are shown as Ready to encode. • Encoders experiencing errors are displayed with the cause for error (e.g., "Receive underrun (encoding too complex)").
		
<p>Encoder Individual Controls – The following controls appear individually for each of the up to four encoders.</p>		
<p>Note: Encoder B thru Encoder D have controls identical to those shown here for Encoder A.</p>		
<p>• Int/Ext Metadata Source Select</p>		
		<p>For up to four encoders, individually selects internal metadata or selects external metadata with the failover choices shown.</p> <p>Note: If external metadata choice is selected as source, intended physical source (SMPTE 2020 de-mux from SDI, serial, or decoder (where available)) must be appropriately selected. See External Metadata Select on previous page for more information.</p>

Table 1 +ENCD Option Control List and Descriptions — continued

<div style="background-color: #333; color: white; padding: 5px; text-align: center; font-weight: bold;">Dolby Digital Encoder</div> <div style="display: flex; justify-content: space-around; background-color: #ccc; padding: 2px; margin-top: 5px;"> Encoder Inputs Internal Metadata </div>	<p>(continued)</p>																																																		
<p>• Encoding Select Controls</p> <div style="border: 1px solid #ccc; padding: 5px; margin-top: 10px;"> <div style="background-color: #333; color: white; padding: 2px; text-align: center; font-weight: bold;">Full Encoder A</div> <table style="width: 100%; border-collapse: collapse;"> <tr> <td style="width: 20%;">Metadata Program</td> <td>Program 1 ▼</td> </tr> <tr> <td>Encoder Format</td> <td>Dolby Digital ▼</td> </tr> <tr> <td>Data Rate</td> <td>Not Specified ▼</td> </tr> </table> </div>	Metadata Program	Program 1 ▼	Encoder Format	Dolby Digital ▼	Data Rate	Not Specified ▼	<ul style="list-style-type: none"> • Metadata Program selects Dolby E program when external metadata is being used (from on-card decoder (where available) or external SMPTE 2020 or serial source). • Encoder Format selects either Dolby Digital or Digital Plus when using internal or external metadata. • Data Rate selects encoding data rate from standards rates of 32 kbps to 640 kbps. <p>Note:</p> <ul style="list-style-type: none"> • “Not Specified” setting provides default data rates for mode being encoded. For 5.1, this is 224 kbps; for 2.0, this is 128 kbps. • Data Rate setting here preempts any related setting contained in received external metadata. 																																												
Metadata Program	Program 1 ▼																																																		
Encoder Format	Dolby Digital ▼																																																		
Data Rate	Not Specified ▼																																																		
<div style="background-color: #333; color: white; padding: 5px; text-align: center; font-weight: bold;">Dolby Digital Encoder</div> <div style="display: flex; justify-content: space-around; background-color: #ccc; padding: 2px; margin-top: 5px;"> Encoder Inputs Internal Metadata </div>	<p>Inputs sub-tab provides source routing and gain controls for the 6 input channels supported in 5.1 encoding and stereo channels supported in 2.0 encoding for each of the up to four encoders.</p>																																																		
<div style="border: 1px solid #ccc; padding: 10px;"> <table style="width: 100%; border-collapse: collapse;"> <thead> <tr style="background-color: #333; color: white;"> <th style="width: 20%;"></th> <th style="width: 20%;">Source</th> <th style="width: 30%;">Gain</th> <th style="width: 10%;">Mute</th> <th style="width: 10%;">Peak</th> </tr> </thead> <tbody> <tr> <td>Encoder A Input 1 (L in 5.1)</td> <td>Bus Ch 11 ▼</td> <td><div style="display: flex; align-items: center;"> <div style="flex: 1;"> </div> <div style="flex: 0 0 60px; text-align: right;">0.0 ▼</div> </div> </td> <td style="text-align: center;"><input type="checkbox"/></td> <td style="color: green;">-34.9 dBFS</td> </tr> <tr> <td>Encoder A Input 2 (R in 5.1)</td> <td>Bus Ch 12 ▼</td> <td><div style="display: flex; align-items: center;"> <div style="flex: 1;"> </div> <div style="flex: 0 0 60px; text-align: right;">0.0 ▼</div> </div> </td> <td style="text-align: center;"><input type="checkbox"/></td> <td style="color: green;">-33.1 dBFS</td> </tr> <tr> <td>Encoder A Input 3 (C in 5.1)</td> <td>Bus Ch 3 ▼</td> <td><div style="display: flex; align-items: center;"> <div style="flex: 1;"> </div> <div style="flex: 0 0 60px; text-align: right;">0.0 ▼</div> </div> </td> <td style="text-align: center;"><input type="checkbox"/></td> <td style="color: green;">-20.0 dBFS</td> </tr> <tr> <td>Encoder A Input 4 (LFE in 5.1)</td> <td>Bus Ch 4 ▼</td> <td><div style="display: flex; align-items: center;"> <div style="flex: 1;"> </div> <div style="flex: 0 0 60px; text-align: right;">0.0 ▼</div> </div> </td> <td style="text-align: center;"><input type="checkbox"/></td> <td style="color: green;">-20.0 dBFS</td> </tr> <tr> <td>Encoder A Input 5 (Ls in 5.1)</td> <td>Bus Ch 5 ▼</td> <td><div style="display: flex; align-items: center;"> <div style="flex: 1;"> </div> <div style="flex: 0 0 60px; text-align: right;">0.0 ▼</div> </div> </td> <td style="text-align: center;"><input type="checkbox"/></td> <td style="color: green;">-26.0 dBFS</td> </tr> <tr> <td>Encoder A Input 6 (Rs in 5.1)</td> <td>Bus Ch 6 ▼</td> <td><div style="display: flex; align-items: center;"> <div style="flex: 1;"> </div> <div style="flex: 0 0 60px; text-align: right;">0.0 ▼</div> </div> </td> <td style="text-align: center;"><input type="checkbox"/></td> <td style="color: green;">-29.0 dBFS</td> </tr> <tr> <td colspan="5" style="text-align: center;">⋮</td> </tr> <tr> <td>Encoder D Input 1 (L)</td> <td>Bus Ch 11 ▼</td> <td><div style="display: flex; align-items: center;"> <div style="flex: 1;"> </div> <div style="flex: 0 0 60px; text-align: right;">-20.7 ▼</div> </div> </td> <td style="text-align: center;"><input type="checkbox"/></td> <td style="color: green;">-25.1 dBFS</td> </tr> <tr> <td>Encoder D Input 2 (R)</td> <td>Bus Ch 12 ▼</td> <td><div style="display: flex; align-items: center;"> <div style="flex: 1;"> </div> <div style="flex: 0 0 60px; text-align: right;">-20.1 ▼</div> </div> </td> <td style="text-align: center;"><input type="checkbox"/></td> <td style="color: green;">-24.8 dBFS</td> </tr> </tbody> </table> <div style="display: flex; justify-content: space-around; background-color: #ccc; padding: 2px; margin-top: 5px;"> Encoder Inputs Internal Metadata </div> </div> <p>Individual input source routing controls are provided for each of the up to four encoders. These controls are described in detail on the following pages.</p>			Source	Gain	Mute	Peak	Encoder A Input 1 (L in 5.1)	Bus Ch 11 ▼	<div style="display: flex; align-items: center;"> <div style="flex: 1;"> </div> <div style="flex: 0 0 60px; text-align: right;">0.0 ▼</div> </div>	<input type="checkbox"/>	-34.9 dBFS	Encoder A Input 2 (R in 5.1)	Bus Ch 12 ▼	<div style="display: flex; align-items: center;"> <div style="flex: 1;"> </div> <div style="flex: 0 0 60px; text-align: right;">0.0 ▼</div> </div>	<input type="checkbox"/>	-33.1 dBFS	Encoder A Input 3 (C in 5.1)	Bus Ch 3 ▼	<div style="display: flex; align-items: center;"> <div style="flex: 1;"> </div> <div style="flex: 0 0 60px; text-align: right;">0.0 ▼</div> </div>	<input type="checkbox"/>	-20.0 dBFS	Encoder A Input 4 (LFE in 5.1)	Bus Ch 4 ▼	<div style="display: flex; align-items: center;"> <div style="flex: 1;"> </div> <div style="flex: 0 0 60px; text-align: right;">0.0 ▼</div> </div>	<input type="checkbox"/>	-20.0 dBFS	Encoder A Input 5 (Ls in 5.1)	Bus Ch 5 ▼	<div style="display: flex; align-items: center;"> <div style="flex: 1;"> </div> <div style="flex: 0 0 60px; text-align: right;">0.0 ▼</div> </div>	<input type="checkbox"/>	-26.0 dBFS	Encoder A Input 6 (Rs in 5.1)	Bus Ch 6 ▼	<div style="display: flex; align-items: center;"> <div style="flex: 1;"> </div> <div style="flex: 0 0 60px; text-align: right;">0.0 ▼</div> </div>	<input type="checkbox"/>	-29.0 dBFS	⋮					Encoder D Input 1 (L)	Bus Ch 11 ▼	<div style="display: flex; align-items: center;"> <div style="flex: 1;"> </div> <div style="flex: 0 0 60px; text-align: right;">-20.7 ▼</div> </div>	<input type="checkbox"/>	-25.1 dBFS	Encoder D Input 2 (R)	Bus Ch 12 ▼	<div style="display: flex; align-items: center;"> <div style="flex: 1;"> </div> <div style="flex: 0 0 60px; text-align: right;">-20.1 ▼</div> </div>	<input type="checkbox"/>	-24.8 dBFS
	Source	Gain	Mute	Peak																																															
Encoder A Input 1 (L in 5.1)	Bus Ch 11 ▼	<div style="display: flex; align-items: center;"> <div style="flex: 1;"> </div> <div style="flex: 0 0 60px; text-align: right;">0.0 ▼</div> </div>	<input type="checkbox"/>	-34.9 dBFS																																															
Encoder A Input 2 (R in 5.1)	Bus Ch 12 ▼	<div style="display: flex; align-items: center;"> <div style="flex: 1;"> </div> <div style="flex: 0 0 60px; text-align: right;">0.0 ▼</div> </div>	<input type="checkbox"/>	-33.1 dBFS																																															
Encoder A Input 3 (C in 5.1)	Bus Ch 3 ▼	<div style="display: flex; align-items: center;"> <div style="flex: 1;"> </div> <div style="flex: 0 0 60px; text-align: right;">0.0 ▼</div> </div>	<input type="checkbox"/>	-20.0 dBFS																																															
Encoder A Input 4 (LFE in 5.1)	Bus Ch 4 ▼	<div style="display: flex; align-items: center;"> <div style="flex: 1;"> </div> <div style="flex: 0 0 60px; text-align: right;">0.0 ▼</div> </div>	<input type="checkbox"/>	-20.0 dBFS																																															
Encoder A Input 5 (Ls in 5.1)	Bus Ch 5 ▼	<div style="display: flex; align-items: center;"> <div style="flex: 1;"> </div> <div style="flex: 0 0 60px; text-align: right;">0.0 ▼</div> </div>	<input type="checkbox"/>	-26.0 dBFS																																															
Encoder A Input 6 (Rs in 5.1)	Bus Ch 6 ▼	<div style="display: flex; align-items: center;"> <div style="flex: 1;"> </div> <div style="flex: 0 0 60px; text-align: right;">0.0 ▼</div> </div>	<input type="checkbox"/>	-29.0 dBFS																																															
⋮																																																			
Encoder D Input 1 (L)	Bus Ch 11 ▼	<div style="display: flex; align-items: center;"> <div style="flex: 1;"> </div> <div style="flex: 0 0 60px; text-align: right;">-20.7 ▼</div> </div>	<input type="checkbox"/>	-25.1 dBFS																																															
Encoder D Input 2 (R)	Bus Ch 12 ▼	<div style="display: flex; align-items: center;"> <div style="flex: 1;"> </div> <div style="flex: 0 0 60px; text-align: right;">-20.1 ▼</div> </div>	<input type="checkbox"/>	-24.8 dBFS																																															

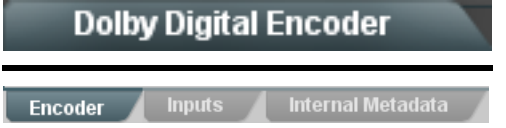
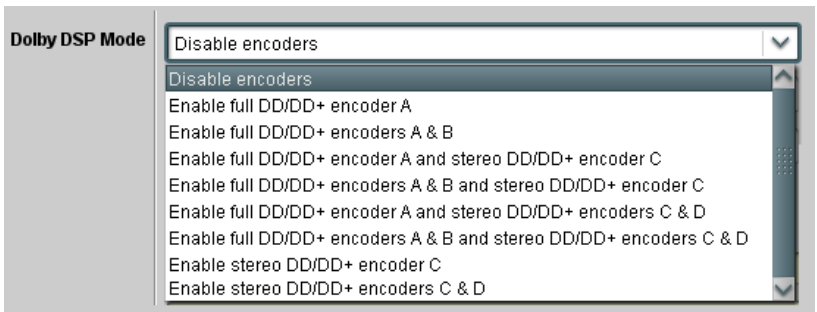
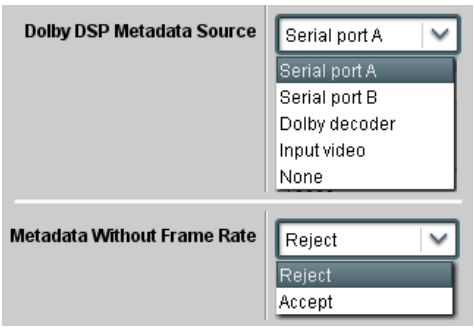
Table 1 +ENCD Option Control List and Descriptions — continued

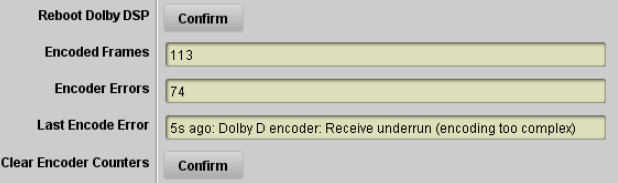
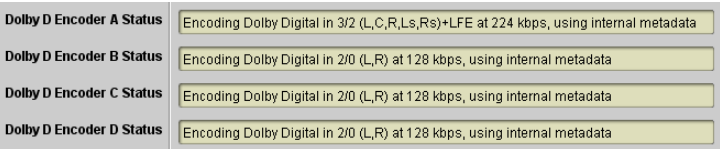
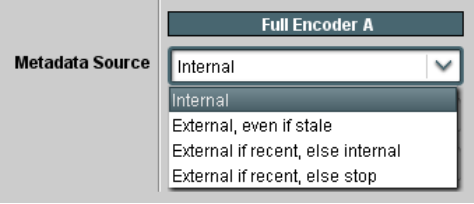

		<p>(continued)</p>
		
<p>Note: Encoder B thru Encoder D have controls similar to those shown here for Encoder A. (Encoders C and D only have two channels per encoder but otherwise function identically to those shown here.)</p>		
<p>• Source Select</p> 	<p>Selects the input channel mapping. Drop-down lists for encoder inputs Input 1 thru Input 6 can be independently sourced from any the following sources:</p> <ul style="list-style-type: none"> • Bus 1 thru Bus 16: Routes card bus channels (which transport input embedded, discrete AES, and/or analog inputs through the card). • Upmix (L, R, C, LFE, Ls, RS) (only with Upmixing option): Routes card DSP-generated upmixed channels to Dolby® encoder input channel. • LP5.1, LP2 Sources (only with Loudness Processor option): Routes DSP loudness processed 5.1 or stereo sources to Dolby® encoder input channel. • Tone 1 thru Tone 8: Routes card internal tone generator sources to Dolby® encoder input channel. • Silence: Routes silence to Dolby® encoder input channel. 	
<p>• Gain / Mute Control</p> 	<p>Provides relative gain (in dB) control and peak level display for corresponding encoder input. Also provides a channel Mute control.</p> <p>(-80 to +20 dB range in 0.1 dB steps; unity = 0.0 dB)</p>	

Table 1 +ENCD Option Control List and Descriptions — continued

Dolby Digital Encoder

Internal Metadata sub-tab provides individual internal metadata audio production and bitstream controls for the up to four encoders.

Encoder

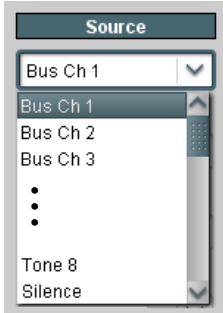
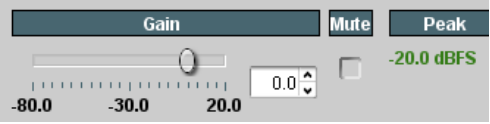
Inputs

Internal Metadata

Note:

- Information provided here is intended as an overview of the screen. Displayed parameters are per ATSC A/52B definitions. Refer to ATSC A/52B for detailed descriptions and background.
- Default settings provide typically accepted parametric settings for each Audio Coding Mode. If settings are changed, note that settings performed here have a profound effect on program material technical and aesthetic aspects. Setup should **only** be performed by authorized personnel.
- Although Stereo Encoders C and D have Coding Mode drop-downs that have settings greater than 2/0, settings greater than 2/0 automatically revert to 2/0 if settings exceeding 2/0 are attempted.

Full Encoder A

Bitstream Mode: Complete Main

Coding Mode: 3/2 (L,C,R,Ls,Rs)

Center Mix Level: -3dB

Surround Mix Level: -3dB

Dolby Surround Mode: Not Indicated

LFE Channel: LFE Channel On

Dialogue Normalization: -24 dB

Audio Production Information: Not Present

Mix Level: 105 dB

Room Type: Not Indicated

⋮

Dolby Headphone encoded: Not Indicated

A/D Converter Type: Standard

DC Highpass Filter: Enabled

Bandwidth Lowpass Filter: Enabled

LFE Channel Lowpass Filter: Enabled

Surround Channel 90 Degree PSF: Enabled

Surround Channel Attenuator: Bypassed

RF Mode Profile: Film: Standard

Line Mode Profile: Film: Standard

Loudness Override: Disabled

Stereo Encoder D

Bitstream Mode: Complete Main

Coding Mode: 2/0 (L,R)

Center Mix Level: -3dB

Surround Mix Level: -3dB

Dolby Surround Mode: Not Indicated

LFE Channel: LFE Channel Off

Dialogue Normalization: -27 dB

Audio Production Information: Present

Mix Level: 105 dB

Room Type: Not Indicated

⋮

Dolby Headphone encoded: Not Indicated

A/D Converter Type: HDCD

DC Highpass Filter: Enabled

Bandwidth Lowpass Filter: Enabled

LFE Channel Lowpass Filter: Enabled

Surround Channel 90 Degree PSF: Enabled

Surround Channel Attenuator: Bypassed

RF Mode Profile: Film: Standard

Line Mode Profile: Film: Standard

Loudness Override: Disabled

Encoder

Inputs

Internal Metadata

For internally generated metadata, individual audio production parametric settings and bitstream information controls allow individual setup for the up to four encoders. Drop-down lists provide on/off settings or selection from a range of appropriate choices in general conformance with Dolby® Digital (AC-3) and Digital Plus encoding and ATSC A/52B practices.

Table 1 +ENCD Option Control List and Descriptions — continued

<p>Metadata Routing and Embedding</p>	<p>Provides input and output support of Dolby metadata routing between the Dolby decoder and serial/video interfaces.</p>
<p>Note:</p> <ul style="list-style-type: none"> • “Dolby Decoder” drop-down choice for this function appear only on cards equipped with an optional Dolby decoder. • After familiarizing yourself with the controls described here, see the following page for an example showing interrelated use of these controls. 	
<p>• Serial Port Output Source Selectors</p> <p>Serial Port A Metadata Source <input type="text" value="Dolby decoder"/></p> <p>Serial Port B Metadata Source <input type="text" value="None"/></p>	<p>For serial ports A and B, selects the source for metadata to be exported (outputted) from the card over a port as shown from the choices listed to the left and shown below. (None selection frees the port to be used as an input.)</p>  <p>Note: If settings here and described below attempt to set a given port as both an output and an input, Serial Ports Conflicts status display indicates conflict (e.g., “Port A configured as both input and output”).</p>
<p>• Embedded Output Metadata Source Selector</p> <p>Embedded Output Metadata Source <input type="text" value="Serial port A"/></p>	<p>For VBI embedding at the card SDI output, selects the source of metadata to be exported (outputted) from the card from the choices listed to the left and shown below.</p> 
<p>• Dolby Encoder Metadata Source Selector</p> <p>Dolby DSP Metadata Source <input type="text" value="Serial port A"/></p>	<p>Selects the metadata source to be imported (inputted) to an on-card Dolby encoder from the choices listed to the left and shown below.</p>  <p>Note: Dolby Decoder described here is Dolby decoder function co-located on card.</p>
<p>• SDI Input VBI Metadata Status Display</p> <p>Input Status <input type="text" value="Receiving embedded metadata on line 13"/></p>	<p>Indicates if Dolby metadata is present on input SDI VBI, as well as VBI line number. (If no metadata present, displays “Not Present”.)</p>

Table 1 +ENCD Option Control List and Descriptions — continued

<div style="background-color: #444; color: white; padding: 5px; text-align: center;">Metadata Routing and Embedding</div>	(continued)
<p>• Metadata Embedding</p> <div style="border: 1px solid #ccc; padding: 10px; background-color: #f9f9f9;"> <p>Embedded Metadata Output <input type="checkbox" value="On"/></p> <p>Embedded Output Line <input type="text" value="13"/> ▼</p> </div>	<p>Embedded Metadata Output enables SMPTE 2020-1 metadata embedding in the SDI video output, as selected using controls described above.</p> <p>Embedded Output Line allows selection of SMPTE 2020-1 metadata line location within the VANC space for re-inserted Dolby® metadata.</p> <p>(Range is 9 thru 41)</p> <p>Note:</p> <ul style="list-style-type: none"> • Although the output line drop-down will allow any choice within the 9 thru 41 range, the actual range is automatically clamped (limited to) certain ranges to prevent inadvertent conflict with active picture area depending on video format. • The card does not check for conflicts on a given line number. Make certain the selected line is available and carrying no other data unless existing metadata is to be intentionally overwritten. <p>Typically, when encoding is active it is recommended that any metadata not specifically related to that being used by the encoder be removed (or replaced with metadata being used by the encoder), and also that the line number be set to overwrite obsolete input VBI metadata. Also, the encoded pair carries the up to date metadata within the encoded pair stream. Removing or replacing obsolete metadata avoids any ambiguity of having different metadata packets on multiple lines, or metadata that is not related to the encoding being performed.</p>

Table 1 +ENCD Option Control List and Descriptions — continued

Metadata Routing and Embedding	(continued)
<p>Metadata Routing Example</p> <p>In this example, the on-card Dolby decoder is to receive and decode Dolby E5.1. The baseband outputs are then to be fed to the on-card Dolby Digital encoder, which in turn is set to encode the six audio channels as Dolby Digital Plus 3/2L using metadata from the decoder. Additionally, the decoder metadata is to be outputted from the card over Serial Port A as well as on the SDI output (SMPTE 2020 VBI on line 13).</p> <p>Note that this setup uses metadata directly from the decoder. In setups like this where external metadata is to directly control an encoder, intermediate processing elements (such as upmixing or loudness processing) should not be inserted in the baseband audio path between the decoder and encoder (“Baseband 5.1 audio” in the example below); if intermediate processing elements are included, metadata values from the decoder will not be in agreement with the baseband audio fed to the encoder.</p>	
	<p>Decoder metadata is exported (outputted) from the card on Serial Port A</p> <p>If desired, Decoder can serve as the metadata source for SMPTE 2020 SDI output embedding .</p> <p>Decoder serves as the external metadata source for the on-card Dolby encoder</p> <p>SMPTE 2020 SDI output metadata embedding is enabled and set for VBI line 13</p>
	<p>The encoder is set to use external metadata (in this case, on-card decoder metadata as set on the Metadata Routing and Embedding tab shown above, or on the Encoder Dolby DSP Metadata Source selector)</p> <p>On the on-card Dolby encoder, Format and Rate are set for Dolby Digital Plus and Rate as desired</p>

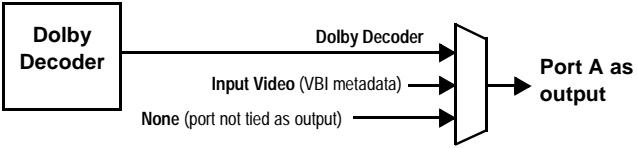
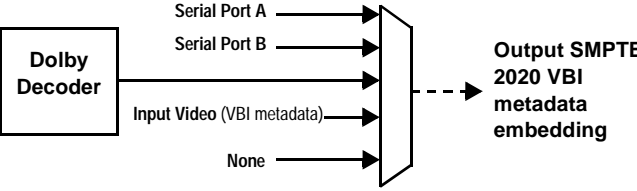
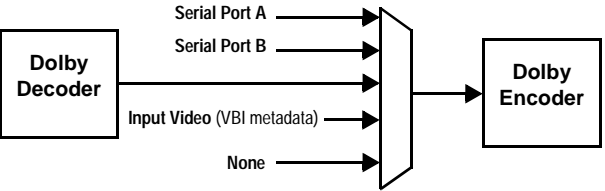
Dolby® E Decode-to-Digital Plus Re-Encode for Emission Example

Note: This example includes descriptions of the on-card Dolby Decoder (option +DEC). This option is **not** part of option +ENCD.

The example here shows how to use the same-card Dolby decoder and encoder controls and audio routing controls for four-language program material support to:

- Receive and decode Dolby E 4x2 containing four-language stereo programming:
Language A = pair 1
Language B = pair 3
Language C = pair 4
Language D = pair 2
- Apply the decoded Dolby E feed to the four same-card Dolby Digital encoders (**ENCD-A** thru **ENCD-D**).
- Use the multi-program external metadata sourced from the decoded E 4x2 stream to independently direct the four Dolby Digital re-encoded streams.
- Output the Dolby Digital encoded pairs on Emb Ch 1/2 thru Ch 7/8.

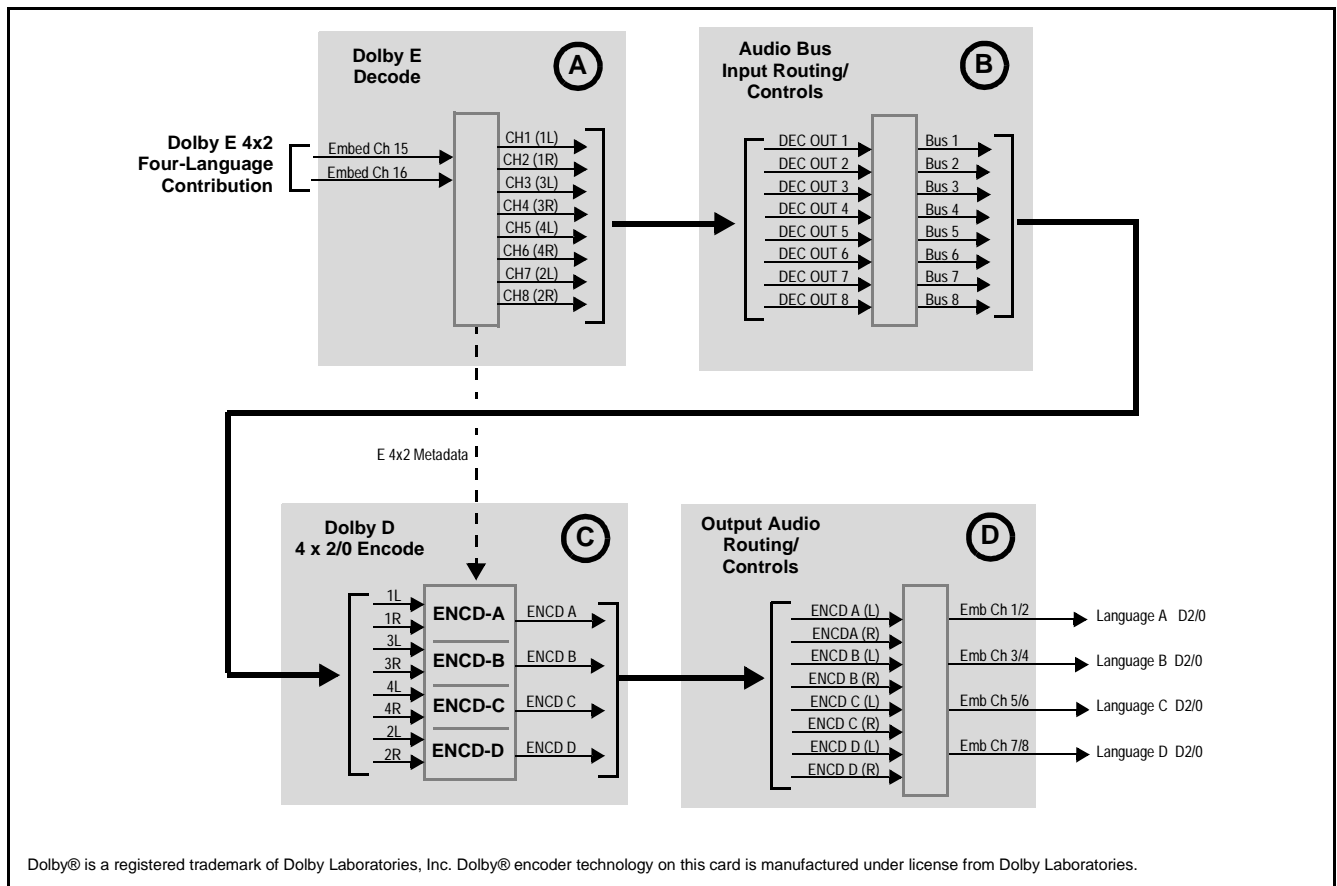
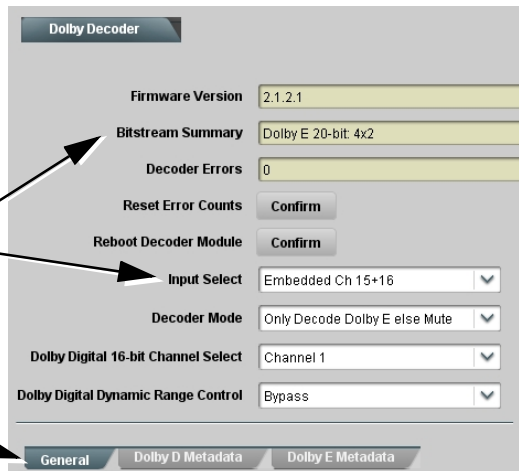
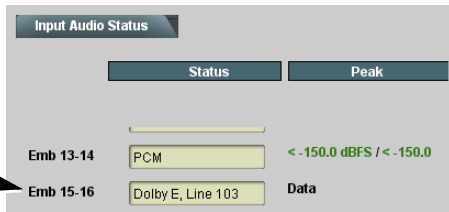

Figure 2 Example Routing and Dolby Re-Encode Processing (Sheet 1 of 4)

(A)



Noting that the incoming Dolby E 4x2 stream is on Emb Ch 15/16 (as shown on the **Input Audio Status** tab), the **Dolby Decoder** tab is then set to use channel pair Emb 15/16. The **Bitstream Summary** display confirms that the selected pair is carrying Dolby E 4x2 data, with further details available using the **Dolby E Metadata** sub-tab.

In this example, the Dolby E Metadata tab confirms four, 2/0 channel encoding.

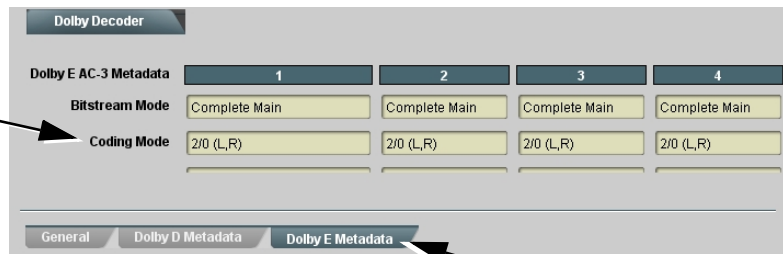

(B)

Next, on the **Audio Bus Input Routing/Controls** tab, the eight resulting decoded Dolby channels for the four decoded pairs are routed on the card bus.

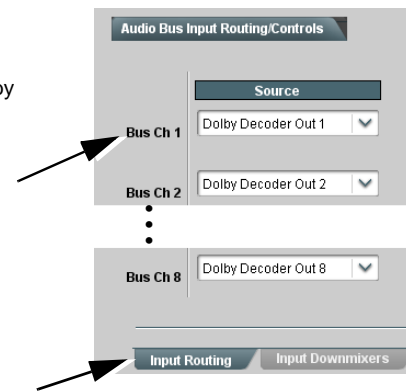

(C)

On the **Dolby Digital Encoder** tab / **Encoder** sub-tab, for this example **DSP Mode** is set to use all four encoders. (Note that the mode displayed here for encoders A and B only indicates the maximum setting; actual mode is a function of other settings or from external metadata).

Since this example is to use **external** metadata from the on-card Dolby decoder, the **Metadata Source** selector is then set to **Dolby Decoder**. This metadata will determine the encoding modes for all four encoders.

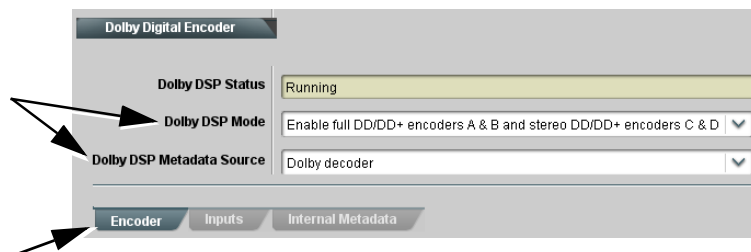
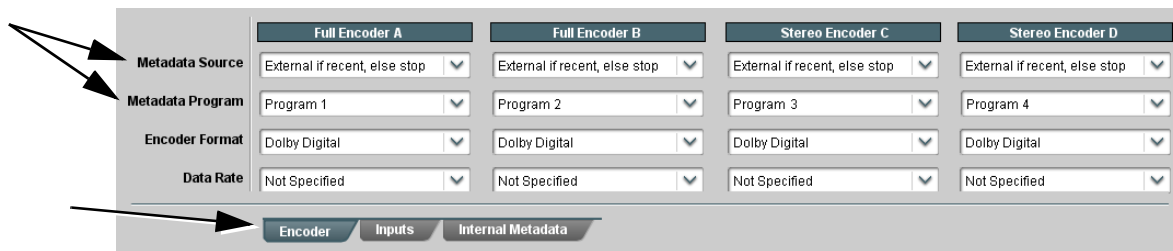

Figure 2 Example Routing and Dolby Re-Encode Processing (Sheet 2 of 4)

©

On the **Encoder** sub-tab, now each of the four encoders A thru D can be set to use external metadata, along with the individual program numbers associated with the encoding programs therein. In this example, Programs 1 thru 4 are to determine the settings for the four pairs carried on this stream. As such, the four encoders here are set to respectively use Programs 1 thru 4.

The Data Rate setting of Not Specified results in the default encoding rate for the selected mode (see Dolby Encoder, p. 5 for more information).



©

The **Input** sub-tab is selected to route audio to the encoder inputs. Because the Dolby decoded channels were routed onto Bus Ch 1 thru Bus Ch 8 earlier, these four stereo pairs are now routed directed to the four stereo pair inputs on encoders A thru D as shown here.

Note: Encoders A and B have 5.1-channel input routing selectors. When these encoders are used for less than six channels, set the selectors for unused inputs to Silence.

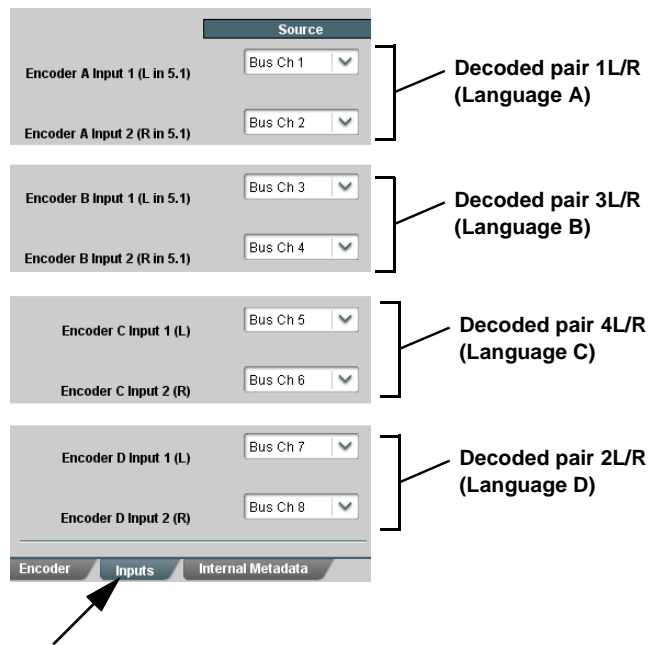

Figure 2 Example Routing and Dolby Re-Encode Processing (Sheet 3 of 4)

D

The four Dolby Digital 2/0 encoded pairs (used for Language A thru Language D) can now be outputted from the card. In this example, these channels will be outputted over embedded audio.

On the **Output Audio Routing/Controls** tab, Emb Ch 1 thru Ch 8 are set to carry the four Dolby Digital 2/0 encoded pairs as shown here.

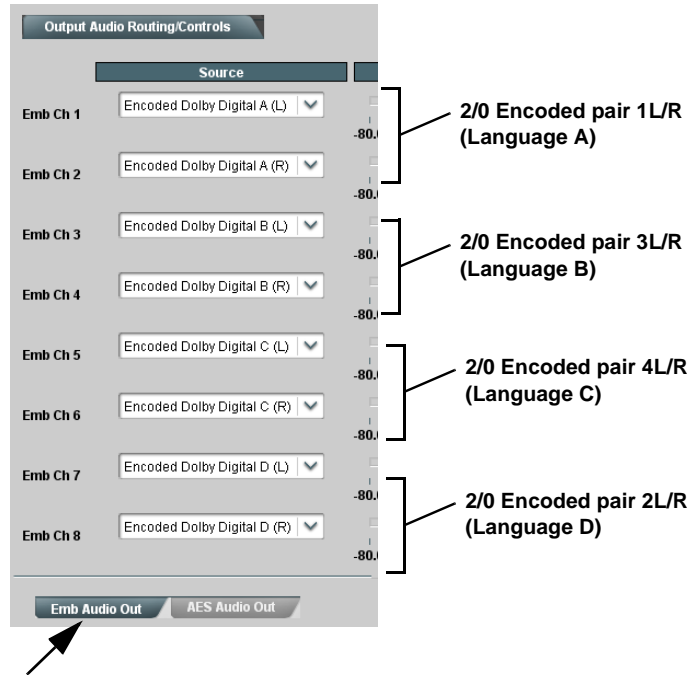

Figure 2 Example Routing and Dolby Re-Encode Processing (Sheet 4 of 4)



Cobalt Digital Inc.

2406 E. University Ave.
Urbana, IL 61802
Voice 217.344.1243 • Fax 217.344.1245
www.cobaltdigital.com