

9000-Series

Audio Upmixer (+UM) Option

Manual Supplement



Cobalt Digital Inc.

2406 E. University Ave.
Urbana, IL 61802
Voice 217.344.1243 • Fax 217.344.1245
www.cobaltdigital.com

Overview

This manual supplement provides descriptions and operating instruction for the Audio Upmixing Option (+UM) on Cobalt® COMPASS™ (9000-Series) cards equipped with this option. This option (identified in Cobalt® price lists as “+UM”) can be purchased upon initial order, or field-activated using a key string which is sent to you when this option is purchased. Additional functions, displays, and/or controls for the Audio Upmixing Option are described in this supplement. Refer to the card Owner or Product Manual for all other information pertaining to the card.

Note: Generic information provided here in examples may include functionality not present on a particular card (for example, discrete AES input/outputs).

Audio Upmixing Functional Description

Note: Upmix function is an optional licensable feature. This function and its controls appear only when a license key is entered and activated.

The 2.0-to-5.1 upmixer function receives a normal PCM stereo pair from the Audio Routing/Gain Control function and upmixes the pair to provide 5.1 channels (Left (**L**), Right (**R**), Center (**C**), Low Frequency Effects (**LFE**), Left Surround (**Ls**), and Right Surround (**Rs**)). Whenever the upmixer is active, it overwrites the six selected channels with the new 5.1 upmix signals (including replacing the original source stereo **L** and **R** inputs with new **L** and **R** signals).

The 2.0-to-5.1 upmixer can be set to upmix in any of three modes: Always upmix, Bypass upmix, or Auto enable/bypass upmixing. The Auto upmixing mode looks at the signal levels on the selected channels and compares them to a selectable level threshold. It then determines whether or not to generate 5.1 upmixing from the stereo pair as follows:

- If the upmixer detects signal level **below** a selected threshold on **all four** of the selected channels designated as **C**, **LFE**, **Ls**, and **Rs**, this indicates to the upmixer that these channels are not carrying 5.1. In this case, the upmixer overwrites all six selected channels with the new 5.1 content.
- If the upmixer detects signal level **above** a selected threshold on **any** of the four selected channels designated as **C**, **LFE**, **Ls**, and **Rs**, this indicates to the upmixer that the channel(s) are already carrying viable 5.1 content. In this case, the upmixer is bypassed, allowing the original channels to pass unaffected.

The examples in Figure 1 show the automatic enable/disable up-mixing function applied to example selected channels **Emb Ch 1** thru **Emb Ch 6**. As shown and described, the processing is contingent upon the signal levels of the channels selected to carry the new 5.1 upmix relative to the selected threshold (in this example, -60 dBFS). Note also that this function is applied **after** the Audio Routing/Gain Control function. Because all audio inputs pass through the Audio Routing/Gain Control function before the upmixer, the upmixer can use embedded, AES discrete, and/or analog audio sources.

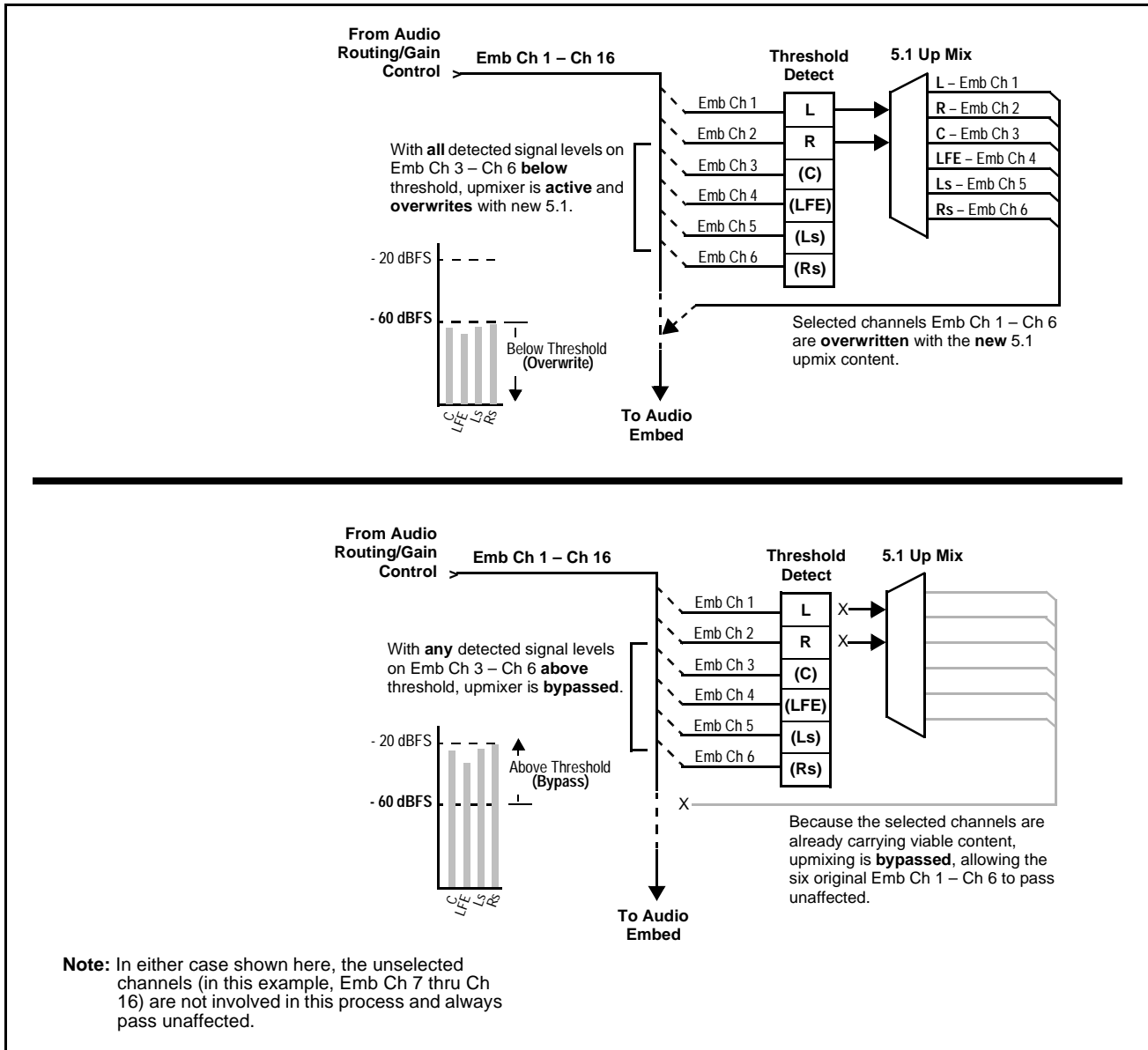



Figure 1 Upmix Auto Enable/Bypass with Example Sources

Activating the Audio Upmixing Optional Feature

Your card may need activation of this feature by means of a key code which is received from Cobalt® when you purchase this feature.

Presence of this feature of your card is denoted by **Audio Upmixer** appearing on the **Licensable Features** page when the **Licensable Features** tab is selected in DashBoard™.

If this feature does not appear, select the **Licensable Features** tab and activate the feature as described below.

	Allows activation of optional licensed features.
<p>Note: For card pre-ordered with licensed feature(s), the activation steps described below are not required; the feature will already be installed activated. To order features and obtain a license key, contact Cobalt® sales at sales@cobaltdigital.com or at the contact information in Contact Cobalt Digital Inc. in Chapter 1, "Introduction". Please provide the "SSN" number of your card (displayed in the Card Info pane) when contacting us for your key.</p>	
<p>• License Feature Key Entry window</p> 	<p>Activate licensable feature as described below.</p> <ol style="list-style-type: none">1. Enter the feature key string in the Feature Key box. Press return or click outside of the box to acknowledge entry. (Entry of a particular key validates activation as well as selects the Audio Upmixing feature if multiple optional feature are available for a particular card.) Note: Entry string is case sensitive. Do not enter any spaces.2. In the DashBoard™ Card Info pane, wait for the feature identification to be shown for the card product number and Valid Key Entered to be displayed. This indicates the key was correctly entered and recognized by the card. Note: If DashBoard™ card function submenu/control pane does not re-appear, close the card and re-open it.3. Click and confirm Reboot. When the card function submenu/control pane appears again, the licensable feature will be available. Note: Applying the licensable feature and its reboot has no effect on prior settings. All control settings and drop-down selections are retained.

Audio Upmixing Submenu List and Descriptions

Table 1 individually lists and describes the Audio Upmixing controls available using DashBoard™ for cards equipped with this feature option. Where helpful, examples showing usage of a control are also provided.

Note: All numeric (scalar) parameters displayed on DashBoard™ can be changed using the slider controls,  arrows, or by numeric keypad entry in the corresponding numeric field. (When using numeric keypad entry, add a return after the entry to commit the entry.)

Table 1 Audio Upmixing Option Control List and Descriptions

	<p>Audio Upmixing controls are located on the Audio Mixing page (along with the standard audio mixing controls).</p>
<p>Note:</p> <ul style="list-style-type: none"> • Channel sources used by the upmixer are post-processed signals received from the Audio Routing/Gain Control function. When active, channel selections made using this function are directly embedded in the output SDI or AES discrete pairs. Refer to Audio Upmixing Functional Description for detailed functional description and signal flow. • For any six channels selected for this function, Left and Right channel selections always serve as the stereo input pair. 	
<p>• 2.0-to-5.1 Up Mixer Selection</p>	<p>Separate drop-down lists for Left, Right, Center, LFE, Left Surround, and Right Surround allow embedded, AES, or analog channel audio source selection, and embedded or AES discrete channel assignments for the six generated 5.1 channels.</p>
	
<p>The example below shows selection of embedded channels 1 and 2 as the received stereo source (Embed Ch1 and Ch 2 for Left and Right drop-down list selections in the Up Mixer Selection tool).</p>	
<p>Using the setup shown in the example, when upmix is active the embedded channel 1/2 stereo pair is overwritten with the new stereo pair L/R on channels 1/2. As selected in the example, the additional 5.1 channels C, LFE, Left Surround (Ls), and Right Surround (Rs) overwrite Emb Ch 3 – Ch 6, respectively.</p>	
	

Table 1 Audio Upmixing Option Control List and Descriptions — continued



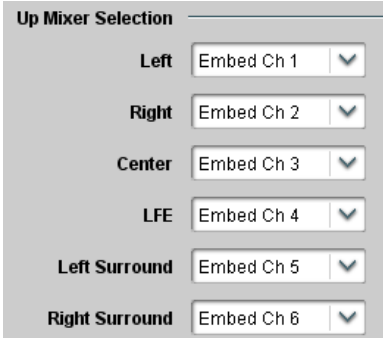
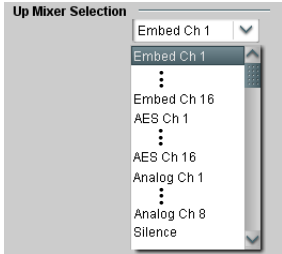
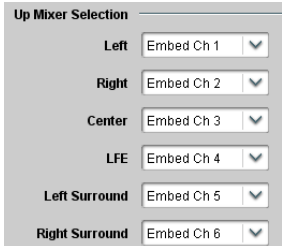
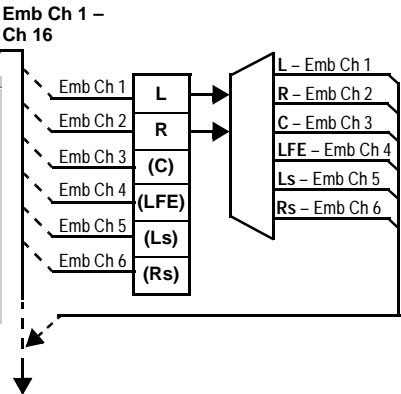

<div style="background-color: #333; color: white; padding: 5px; text-align: center; font-weight: bold;">Audio Mixing</div>	(continued)
<p>• Up Mixer Mode Control</p> 	<p>Enables or bypasses upmixer as follows:</p> <ul style="list-style-type: none"> • Auto: Automatic enable/bypass of 5.1 upmix function as follows: <ul style="list-style-type: none"> • If detected signal level on all four of the selected channels designated as Center, LFE, Left Surround, and Right Surround are below the level threshold set using the 5.1 Detection Threshold control, upmixer overwrites all six selected channels with the new 5.1 content generated by the upmixer. • If detected signal level on any of the four of the selected channels designated as Center, LFE, Left Surround, and Right Surround is above the level threshold set using the 5.1 Detection Threshold control, upmixer is bypassed and the original channels pass unaffected. • Always Upmix: Manual enable turns on upmixer and overwrites content on all six selected channels with new 5.1 content generated by the upmixer regardless of original signal level or content. • Bypass: Manual disable bypasses the upmixer. When bypassed, the six embedded audio channels pass unaffected.
<p>• Up Mixer Status Display</p> 	<p>Shows activity status of upmixer processing as follows:</p> <ul style="list-style-type: none"> • Auto Mode - Currently Upmixing: With upmixer enable set to Auto, indicates selected channels designated as Center, LFE, Left Surround, and Right Surround are clear for use (as described above); upmixer is currently up-mixing received stereo pair and overwriting the six selected channels with new 5.1 upmix. • Auto Mode - Currently Bypassed: With upmixer enable set to Auto, indicates selected channels designated as Center, LFE, Left Surround, and Right Surround have content (such as existing original 5.1 or other content); upmixer is bypassed (disabled) and allows normal passage of six selected channels. • Upmixing: Indicates upmixer is manually enabled (set to Always Upmix) and is currently up-mixing received stereo pair and overwriting the six selected channels with new 5.1 upmix. • Bypassed: Indicates upmixer is manually disabled (set to Bypass) and is currently passing all selected channels unaffected.
<p>• Auto Crossfade Speed Controls</p> 	<p>Individual controls select the relative crossfade transition speed between Upmix to Bypass (going to inactive; from 5.1 to 2.0) and Bypass to Upmix (going to active; from 2.0 to 5.1) when upmixer enable is set to Auto and the active threshold (as set by the 5.1 Detection Threshold control) is crossed in either direction.</p> <p>To suit program material and production aesthetic preferences, several choices are available as shown to the left. Slower settings allow for a more gradual transition between modes, however with a longer interval before levels stabilize. Faster settings conversely allow for a smaller interval before levels stabilize, however with greater perceived abruptness.</p>

Table 1 Audio Upmixing Option Control List and Descriptions — continued

<div style="background-color: #333; color: white; padding: 5px; text-align: center; font-weight: bold;">Audio Mixing</div>	(continued)
<p>• 5.1 Detection Threshold Control</p> 	<p>Adjusts the threshold at which selected channels designated as C, LFE, Ls, and Rs are considered to have viable content, or at which signal levels can be considered insignificant when upmixer enable is set to Auto. Setting affects automatic enable/bypass of 5.1 upmix function as follows:</p> <ul style="list-style-type: none"> • If detected signal level on all four of the selected channels designated as Center, LFE, Left Surround, and Right Surround are below the level threshold set using the 5.1 Detection Threshold control, upmixer allows overwrite of all six selected channels with the new 5.1 signal complement. • If detected signal level on any of the four of the selected channels designated as Center, LFE, Left Surround, and Right Surround is above the level threshold set using the 5.1 Detection Threshold control, upmixer is bypassed, thereby releasing the selected six channels and allowing the original channels to pass unaffected. <p>(Range is -150 dB to 0 dB in 0.1dB steps; 0 dB equivalent to +24 dBu=> 0 dBFS; default = 0%)</p> <hr/> <p>Typically, the 5.1 Detection Threshold control should be set to provide a usable threshold that maintains a threshold at which valid levels large enough over the threshold disable the auto upmix (A, left), while nuisance levels considerably below the threshold (B, left) are rejected, allowing the upmixer to stay locked in the enabled mode and overwrite these signals with the new signals.</p>  <p>Optimum setting is dependent on program material general overall levels. A -60 dB setting is recommended for material closely adhering to the SMPTE -20 dBFS Alignment level for normal material such as dialog.</p>
<p>• Center Width Control</p> 	<p>Adjusts center channel content (in terms of percentage) applied to L and R channels.</p> <ul style="list-style-type: none"> • Minimum setting keeps all L+R (mono) content confined to center (C) channel, with any center channel content removed from L and R channels. • Higher settings progressively blend respective L and R mono content back into L and R channels, with 100% setting resulting in center channel level going to zero and L/R channels becoming normal L/R channels containing some mono content. <p>(0% to 100% range in 0.1% steps; default = 0%)</p>
<p>• Surround Depth Control</p> 	<p>Adjusts surround channel content (in terms of percentage) applied to Ls and Rs channels.</p> <ul style="list-style-type: none"> • Maximum setting results in greatest surround channel levels. • Lower settings progressively diminish surround channel levels, with 0% setting resulting in no Ls or Rs level, with Ls and Rs content progressively folded back into L and R, respectively. <p>(0% to 100% range in 0.1% steps; default = 100%)</p>

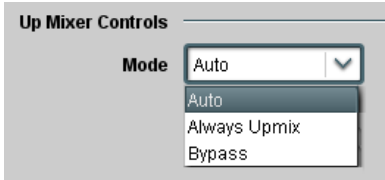
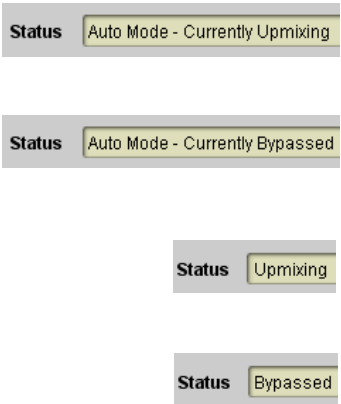
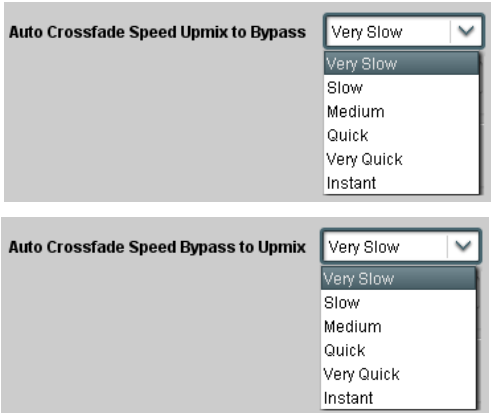

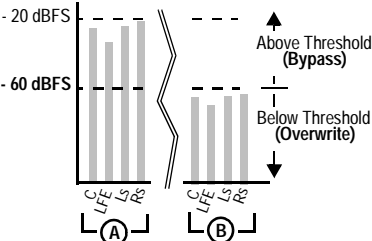
Cobalt Digital Inc.

2406 E. University Ave.
Urbana, IL 61802
Voice 217.344.1243 • Fax 217.344.1245
www.cobaltdigital.com