Fusion^{3G}

9931-EMDE



**3G/HD/SD-SDI
Embedder/De-Embedder
*Product Manual***

COBALT

Cobalt Digital Inc.

2506 Galen Drive
Champaign, IL 61821
Voice 217.344.1243 • Fax 217.344.1245
www.cobaltdigital.com

Copyright

©Copyright 2016, Cobalt Digital Inc. All Rights Reserved.

Duplication or distribution of this manual and any information contained within is strictly prohibited without the express written permission of Cobalt Digital Inc. This manual and any information contained within, may not be reproduced, distributed, or transmitted in any form, or by any means, for any purpose, without the express written permission of Cobalt Digital Inc. Reproduction or reverse engineering of software used in this device is prohibited.

Disclaimer

The information in this document has been carefully examined and is believed to be entirely reliable. However, no responsibility is assumed for inaccuracies. Furthermore, Cobalt Digital Inc. reserves the right to make changes to any products herein to improve readability, function, or design. Cobalt Digital Inc. does not assume any liability arising out of the application or use of any product or circuit described herein.

Trademark Information

Cobalt[®] is a registered trademark of Cobalt Digital Inc.

FUSION3G[®] and **COMPASS**[®] are registered trademarks of Cobalt Digital Inc.

openGear[®] is a registered trademark of Ross Video Limited. **DashBoard**[™] is a trademark of Ross Video Limited. Dolby[®] encoder technology on this card is manufactured under license from Dolby Laboratories. **Dolby**[®] is a registered trademark of Dolby Laboratories, Inc. Other product names or trademarks appearing in this manual are the property of their respective owners.

Linear Acoustic[®], **AEROMAX**[®], and **UPMAX**[®] are registered trademarks of Linear Acoustic, Inc. 2.0-to-5.1 audio upmixer licensed feature uses the **AutoMAX-II**[™] upmix algorithm provided under license from **Linear Acoustic Inc.** Loudness processor licensed feature uses **AEROMAX**[®] algorithms provided under license from **Linear Acoustic Inc.** **Linear Acoustic**, the "LA" symbol, **AutoMAX**, and **AutoMAX-II** are trademarks of Linear Acoustic Inc. All Rights Reserved.

Congratulations on choosing the Cobalt[®] 9931-EMDE 3G/HD/SD-SDI Embedder/De-Embedder. The 9931-EMDE is part of a full line of modular processing and conversion gear for broadcast TV environments. The Cobalt Digital Inc. line includes video decoders and encoders, audio embedders and de-embedders, distribution amplifiers, format converters, remote control systems and much more. Should you have questions pertaining to the installation or operation of your 9931-EMDE, please contact us at the contact information on the front cover.

Manual No.:	9931-EMDE-OM
Document Version:	V1.18
Release Date:	December 29, 2016
Applicable for card firmware version: (or greater)	7207
Description of product/manual changes:	- Update manual to reflect product functional changes of latest firmware release.

Table of Contents

Chapter 1	Introduction	1-1
	Overview	1-1
	9931-EMDE Card Software Versions and this Manual	1-2
	Cobalt Reference Guides	1-2
	Manual Conventions	1-3
	Warnings, Cautions, and Notes	1-3
	Labeling Symbol Definitions	1-4
	Safety Summary	1-4
	Warnings	1-4
	Cautions	1-4
	9931-EMDE Base Model and Options	1-5
	9931-EMDE Functional Description	1-6
	9931-EMDE Video/Audio Signal Types	1-6
	9931-EMDE Video and Audio Options	1-7
	Video Subsystem Description	1-8
	Audio Subsection Description	1-13
	Control and Data Input/Output Interfaces	1-21
	User Control Interface	1-22
	9931-EMDE Rear Modules	1-24
	Audio and Video Formats Supported by the 9931-EMDE	1-26
	Technical Specifications	1-26
	Warranty and Service Information	1-31
	Cobalt Digital Inc. Limited Warranty	1-31
	Contact Cobalt Digital Inc.	1-32
Chapter 2	Installation and Setup	2-1
	Overview	2-1
	Setting I/O Switches for Analog Audio (1-8) Ports	2-1
	Installing the 9931-EMDE Into a Frame Slot	2-2
	Installing a Rear Module	2-4
	9931-EMDE Rear Modules	2-7
	Connecting To Phoenix Terminal Connectors	2-15
	Setting Up 9931-EMDE Network Remote Control	2-15

Chapter 3	Operating Instructions	3-1
	Overview	3-1
	Control and Display Descriptions	3-1
	Function Menu/Parameter Menu Overview	3-2
	9931-EMDE Card Edge Controls, Indicators, and Display	3-3
	DashBoard™ User Interface	3-4
	Cobalt® Remote Control Panel User Interfaces	3-5
	Accessing the 9931-EMDE Card via Remote Control.	3-6
	Accessing the 9931-EMDE Card Using DashBoard™.	3-6
	Accessing the 9931-EMDE Card Using a Cobalt® Remote Control Panel.	3-7
	Checking Card Information.	3-8
	Ancillary Data Line Number Locations and Ranges	3-9
	9931-EMDE Function Menu List and Descriptions	3-10
	Video Proc/Color Correction	3-11
	Timecode	3-15
	Closed Captioning	3-19
	Framesync	3-21
	AFD/WSS/VI ARC Controls	3-24
	Video Output Crosspoint Control	3-30
	Input Audio Status	3-31
	Audio Bus Input Routing/Controls	3-32
	Output Audio Routing/Controls	3-42
	Upmixing	3-47
	COM and Metadata Routing	3-50
	GPIO Controls	3-52
	Presets	3-54
	Event Based Preset Loading	3-55
	Audio Routing with GPI Control Example.	3-58
	Troubleshooting	3-63
	Error and Failure Indicator Overview	3-63
	Basic Troubleshooting Checks.	3-67
	9931-EMDE Processing Error Troubleshooting.	3-67
	Troubleshooting Network/Remote Control Errors.	3-70
	What To Do If Your Card Locks Up.	3-70
	In Case of Problems	3-71

Introduction

Overview

This manual provides installation and operating instructions for the 9931-EMDE 3G/HD/SD-SDI Embedder/De-Embedder card (also referred to herein as the 9931-EMDE).

Note: This manual is also applicable for reduced functionality versions:

- 9931-DE (De-embed only)
- 9931-EM (Embed only)

In all other facets, the three cards function identically. (The 9931-DE and 9931-EM can be field-upgraded to full 9931-EMDE functionality using a software upgrade which is performed without removing the card from its frame.)

This manual consists of the following chapters:

- **Chapter 1, “Introduction”** – Provides information about this manual and what is covered. Also provides general information regarding the 9931-EMDE.
- **Chapter 2, “Installation and Setup”** – Provides instructions for installing the 9931-EMDE in a frame, and optionally installing 9931-EMDE Rear Modules.
- **Chapter 3, “Operating Instructions”** – Provides overviews of operating controls and instructions for using the 9931-EMDE.

This chapter contains the following information:

- **9931-EMDE Card Software Versions and this Manual (p. 1-2)**
- **Manual Conventions (p. 1-3)**
- **Safety Summary (p. 1-4)**
- **9931-EMDE Base Model and Options (p. 1-5)**
- **9931-EMDE Functional Description (p. 1-6)**
- **Technical Specifications (p. 1-26)**
- **Warranty and Service Information (p. 1-31)**
- **Contact Cobalt Digital Inc. (p. 1-32)**

9931-EMDE Card Software Versions and this Manual

When applicable, Cobalt Digital Inc. provides for continual product enhancements through software updates. As such, functions described in this manual may pertain specifically to cards loaded with a particular software build. **Cards loaded with initial software builds may not reflect all functionality described in “9931-EMDE Functional Description” of this chapter. Also note that some functions described here are options, and may not appear on all 9931 cards.**

The Software Version of your card can be checked by viewing the **Card Info** menu in DashBoard™. See Checking Card Information (p. 3-8) in Chapter 3, “Operating Instructions” for more information. You can then check our website for the latest software version currently released for the card as described below.

Check our website and proceed as follows if your card’s software does not match the latest version:

<p>Card Software earlier than latest version</p>	<p>Card is not loaded with the latest software. Not all functions and/or specified performance described in this manual may be available.</p> <p>You can update your card with new Update software by going to the Support>Firmware Downloads link at www.cobaltdigital.com. Download “Firmware Update Guide”, which provides simple instructions for downloading the latest firmware for your card onto your computer, and then uploading it to your card through DashBoard™.</p> <p>Software updates are field-installed without any need to remove the card from its frame.</p>
<p>Card Software newer than version in manual</p>	<p>A new manual is expediently released whenever a card’s software is updated and specifications and/or functionality have changed as compared to an earlier version (a new manual is not necessarily released if specifications and/or functionality have not changed). A manual earlier than a card’s software version may not completely or accurately describe all functions available for your card.</p> <p>If your card shows features not described in this manual, you can check for the latest manual (if applicable) and download it by going to the card’s web page on www.cobaltdigital.com.</p>

Cobalt Reference Guides

From the Cobalt® web home page, go to **Support>Reference Documents** for easy to use guides covering network remote control, card firmware updates, example card processing UI setups and other topics.

Manual Conventions

In this manual, display messages and connectors are shown using the exact name shown on the 9931-EMDE itself. Examples are provided below.

- Card-edge display messages are shown like this:

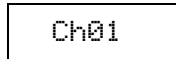

- Connector and control names are shown like this: **AES I/O 8**

In this manual, the terms below are applicable as follows:

- **9931-EMDE** refers to the 9931-EMDE 3G/HD/SD-SDI Embedder/De-Embedder card.
- **Frame** refers to the 20-slot frame that houses the Cobalt[®] COMPASS[®] and/or FUSION3G[®] cards.
- **Device** and/or **Card** refers to a COMPASS[®] and/or FUSION3G[®] card.
- **System** and/or **Video System** refers to the mix of interconnected production and terminal equipment in which the 9931-EMDE and other COMPASS[®] and/or FUSION3G[®] cards operate.
- Functions and/or features that are available only as an option are denoted in this manual like this:



Not all options are covered in this manual. In these cases, Manual Supplement(s) for the option(s) ordered have been included in the binder containing this manual.

Warnings, Cautions, and Notes

Certain items in this manual are highlighted by special messages. The definitions are provided below.

Warnings

Warning messages indicate a possible hazard which, if not avoided, could result in personal injury or death.



Cautions

Caution messages indicate a problem or incorrect practice which, if not avoided, could result in improper operation or damage to the product.

Notes

Notes provide supplemental information to the accompanying text. Notes typically precede the text to which they apply.

Labeling Symbol Definitions

	Important note regarding product usage. Failure to observe may result in unexpected or incorrect operation.
	Electronic device or assembly is susceptible to damage from an ESD event. Handle only using appropriate ESD prevention practices. If ESD wrist strap is not available, handle card only by edges and avoid contact with any connectors or components.
	Symbol (WEEE 2002/96/EC) For product disposal, ensure the following: <ul style="list-style-type: none"> • Do not dispose of this product as unsorted municipal waste. • Collect this product separately. • Use collection and return systems available to you.

Safety Summary

Warnings

! WARNING !

To reduce risk of electric shock do not remove line voltage service barrier cover on frame equipment containing an AC power supply. **NO USER SERVICEABLE PARTS INSIDE. REFER SERVICING TO QUALIFIED SERVICE PERSONNEL.**

! WARNING !

Adhere to GPO port maximum voltage/current limits. This port is specified for low-voltage/low-current control circuits only. Using this port for any other purpose may result in an unsafe condition and can damage the card.



CLASS 1 LASER PRODUCT - IEC 60825-1:2007. Never look into fiber connector or cable end of device transmitting an optical signal. The transmitted light is not visible and can cause permanent eye damage. Do not perform connection/disconnection with sending or receiving device powered.

Cautions

CAUTION

This device is intended for environmentally controlled use only in appropriate video terminal equipment operating environments.

CAUTION

This product is intended to be a component product of an openGear® frame. Refer to the openGear® frame Owner's Manual for important safety instructions regarding the proper installation and safe operation of the frame as well as its component products.

CAUTION

Heat and power distribution requirements within a frame may dictate specific slot placement of cards. Cards with many heat-producing components should be arranged to avoid areas of excess heat build-up, particularly in frames using only convection cooling. The 9931-EMDE has a moderate power dissipation (20 W max.). As such, avoiding placing the card adjacent to other cards with similar dissipation values if possible.

CAUTION

If required, make certain Rear Module(s) is installed before installing the 9931-EMDE into the frame slot. Damage to card and/or Rear Module can occur if module installation is attempted with card already installed in slot.

CAUTION

If card resists fully engaging in Rear Module mating connector, check for alignment and proper insertion in slot tracks. Damage to card and/or Rear Module may occur if improper card insertion is attempted.

9931-EMDE Base Model and Options

(See Figure 1-1.) The **base model** 9931-EMDE provides video processing, embedded and discrete audio support, and timecode/closed captioning support. **Options** add various I/O, video, and audio expanded capabilities to the base model as shown in Figure 1-1 and described below. The various options are described in detail in 9931-EMDE Video and Audio Options (p. 1-7), and as applicable throughout this manual.

As such, the 9931-EMDE is highly suited as a universal processing card with comprehensive audio and video support for environments requiring legacy, current, and advanced platform support.

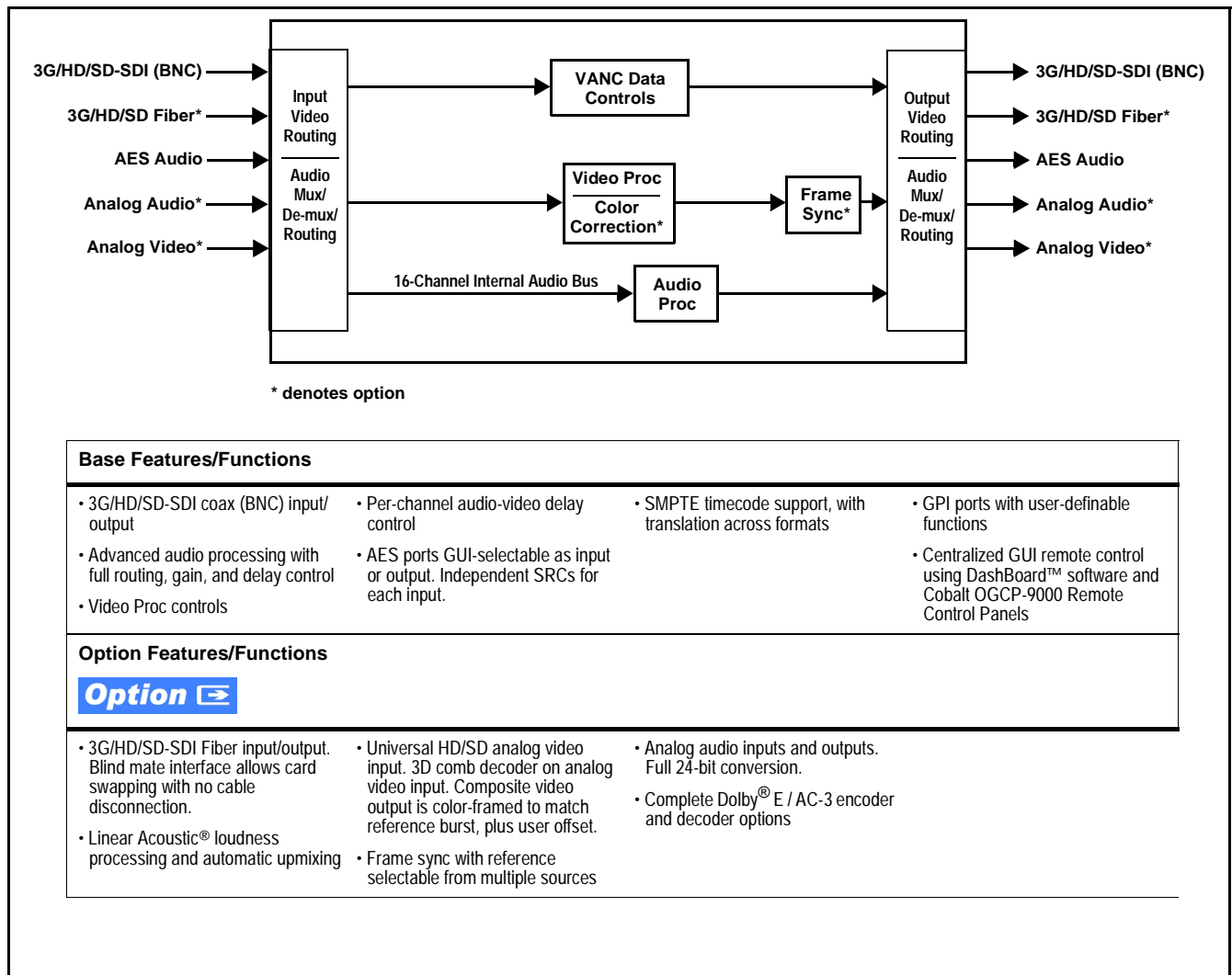

Figure 1-1 9931-EMDE Simplified Overview of Base and Option Features/Functions

9931-EMDE Functional Description

Figures 1-2 and 1-5 show functional block diagrams of the 9931-EMDE video/control and audio subsystems, respectively.

The base 9931-EMDE provides video processing, embedded audio support, and AFD/timecode/closed-captioning support. Various I/O, video, and audio options add expanded capabilities to the base model as described below.

9931-EMDE Video/Audio Signal Types

Table 1-1 lists the video/audio inputs and outputs (available via rear module connections) provided by the 9931-EMDE. Note that some signal types are supported through the use of options, and also require a rear module that supports the connections described here; the complete option/rear module requirement is specified in Table 1-1.

Table 1-1 9931-EMDE Video/Audio Signal Types



Signal ID	Description	Option/Rear Module Package Required
SDI IN A	3G/HD-SD-SDI BNC video input	Standard <input type="checkbox"/> Various Rear Modules offer various SDI BNC input complements. See 9931-EMDE Rear Modules (p. 2-7) for more information.
Fiber Rx-A I/O, Fiber Rx-B I/O Option 	Up to two 3G/HD-SD-SDI fiber LC video inputs; routable to card processing via input crosspoint	<ul style="list-style-type: none"> • Option +FRx (1 Fiber input) • Option +FRx/Tx (1 Fiber input; 1 Fiber output) • Option +FRx/Rx (2 Fiber inputs) <input type="checkbox"/> Requires Expansion Rear Module supporting fiber I/O. See 9931-EMDE Rear Modules (p. 2-7) for more information.
AES Audio IN/OUT (1-16)	Eight AES 3-id BNC pairs; each pair user GUI-selectable as either input or output.	Standard <input type="checkbox"/> Various Rear Modules offer various number of AES pairs supported. See 9931-EMDE Rear Modules (p. 2-7) for more information.
Analog Video/Audio I/O Option 	Up to eight balanced analog audio channels (using Phoenix™ 3-wire terminations); each channel switch-selectable as either input or output. HD/SD composite and component analog I/O	Refer to option Manual Supplement OPT-F3GAN-MS for descriptions of analog video/audio I/O options available.

Table 1-1 9931-EMDE Video/Audio Signal Types — continued

Signal ID	Description	Option/Rear Module Package Required
SDI OUT A	3G/HD-SD-SDI BNC video output	Standard ❑ Various Rear Modules offer various SDI BNC output complements. See 9931-EMDE Rear Modules (p. 2-7) for more information.
<p>Note: The input/output complement listed above and shown in Figures 1-2 and 1-5 represents the maximum capability of the 9931-EMDE. The practical input/output complement is determined by the particular Rear Module used with the 9931-EMDE. Not all options are available concurrently on a single card.</p>		

9931-EMDE Video and Audio Options Option ➔

In addition to the I/O options described in Table 1-1 above, the 9931-EMDE offers several video and audio options described in Table 1-2. Note that several options also require a rear I/O option that supports the video and/or audio options described here; the complete option requirement is specified in Table 1-2.

Table 1-2 9931-EMDE Video/Audio Options

Option	Description	Option/Rear Module Package Required
<p>Note: Options are periodically added for this card. Check for latest options on the card web page at cobaltdigital.com. Most options, in addition to licensing, require that card be loaded with the latest available firmware.</p>		
Video Options		
Color Correction	In addition to standard video proc controls, provides independent RGB channel controls for luma, black, and gamma.	• Option +COLOR
Audio Options		
Linear Acoustic® Loudness Processing software	Linear Acoustic® AEROMAX ® 5.1-channel or stereo audio output loudness processing; several combinations available	<ul style="list-style-type: none"> • Option +LP51 (5.1-Ch loudness processing) • Option +2LP20 (dual independent stereo loudness processing) • Option +LP20 (stereo loudness processing)
OGCP Loudness Meter software (Note 1)	5.1-channel loudness meter in accordance with EBU R128, ATSC A/85 and ITU BS.1770. Allows OGCP-9000 to provide user interface.	• Option +LM
Linear Acoustic® Upmixing software (Note 2)	Linear Acoustic® AUTOMAX ™ converts legacy stereo program audio (from any source received by the card) to 5.1-channel audio.	• Option +UM
Automatic Downmixing	Provides a stereo downmix from selected alternate multi-channel sources if selected primary L/R channels lose signal.	• Option +ADM

Table 1-2 9931-EMDE Video/Audio Options — continued

Option	Description	Option/Rear Module Package Required
Automatic Audio Failover	Provides failover to alternate (“secondary”) channels to substitute for the primary channels in the event of audio signal loss.	• Option +AFO
Dolby® E/AC-3 Decoding	Provides Dolby® E and/or AC-3 decoding from embedded and AES sources.	• Option +DEC <input type="checkbox"/> If serial metadata Rx/Tx support is needed, requires Rear Module with RS-485 port
Dolby® Digital (AC-3), Digital Plus™ Encoding	Provides Dolby® AC-3 encoding from any audio source used by the card (including mixed and loudness-processed audio). Accommodates internally generated and external metadata.	• Option +ENC D <input type="checkbox"/> If serial metadata Rx/Tx support is needed, requires Rear Module with RS-485 port
Dolby® E Encoding	Provides Dolby® E encoding from any audio source used by the card (including mixed and loudness-processed audio). Accommodates internally generated and external metadata.	• Option +ENCE <input type="checkbox"/> If serial metadata Rx/Tx support is needed, requires Rear Module with RS-485 port
<p>Notes: 1. This option must be used in conjunction with a Cobalt® OGCP-9000 Remote Control Panel. The control panel serves as the control/display portal.</p> <p>2. Option +UM can be used in conjunction with Loudness Processing options.</p>		

Video Subsystem Description

Note: Descriptions below include some functions and features that are available only as options.

Video Processor

The 9931-EMDE provides full color processing control (luma gain and lift, chroma saturation, and color phase) of the output video. The color correction option (**+COLOR**) provides independent RGB channel controls for luma, black, and gamma. The color correction function converts the YCbCr SDI input video to the 4:4:4 RGB color space (where the color correction is applied), and then back to YCbCr SDI on the output of the function. Controls are available to adjust each RGB level independently for both white levels (gain) and black levels (offset). Gamma can also be independently adjusted for each RGB channels. Various controls can be ganged to provide adjustment for all three color channels simultaneously.

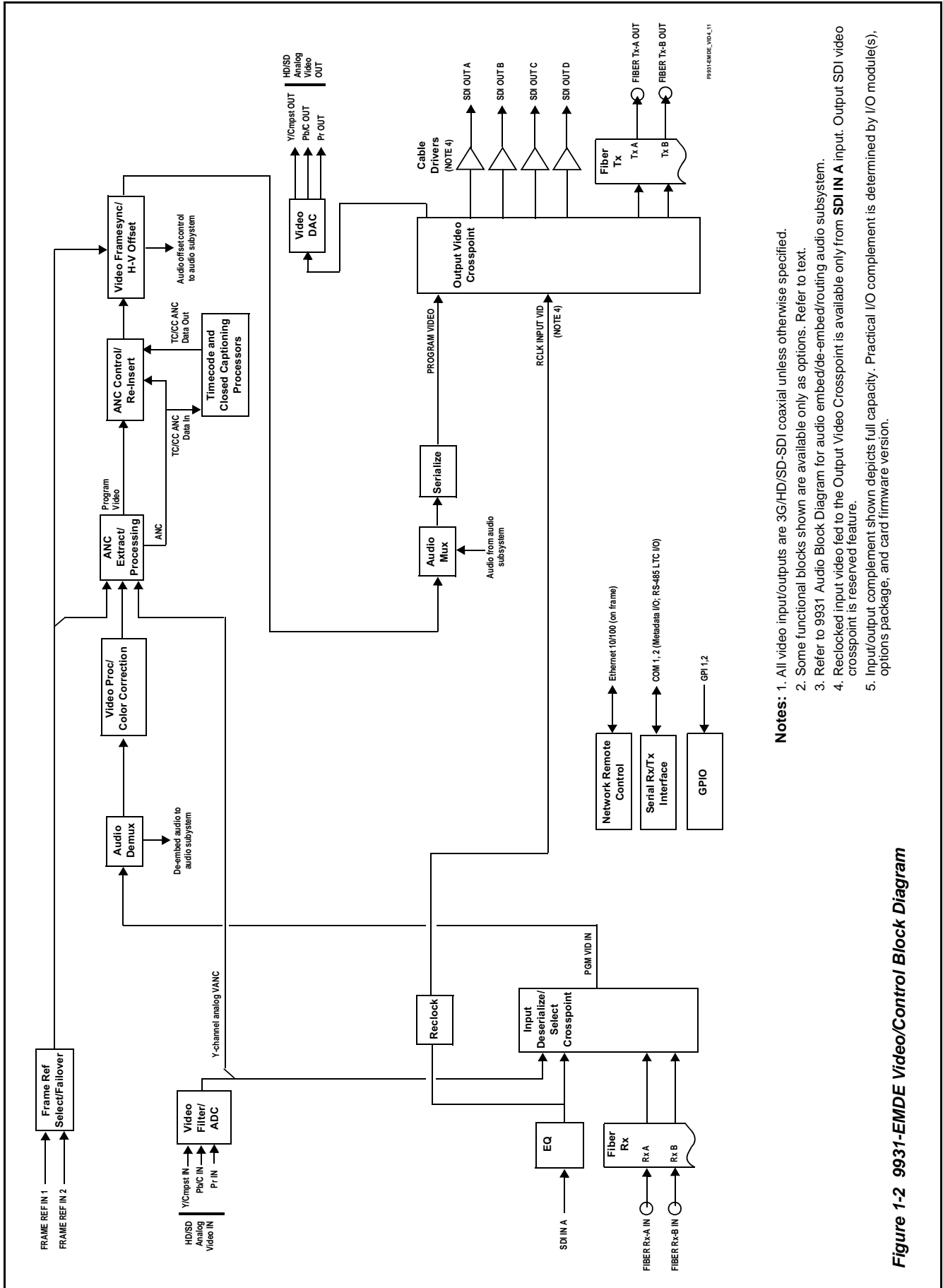

9931-EMDE_V01_L11

- Notes:**
1. All video input/outputs are 3G/HD/SD-SDI coaxial unless otherwise specified.
 2. Some functional blocks shown are available only as options. Refer to text.
 3. Refer to 9931 Audio Block Diagram for audio embed/de-embed/routing audio subsystem.
 4. Reclocked input video fed to the Output Video Crosspoint is available only from **SDI IN A** input. Output SDI video crosspoint is reserved feature.
 5. Input/output complement shown depicts full capacity. Practical I/O complement is determined by I/O module(s), options package, and card firmware version.

Figure 1-2 9931-EMDE Video/Control Block Diagram

Frame Sync Function **Option**

This function provides for frame sync control using either one of two external **FRAME REF IN (1,2)** reference signals distributed with the card frame, or the input video as a frame sync reference.

This function also allows horizontal and/or vertical offset to be added between the output video and the frame sync reference.

Frame sync can select from either of two card frame reference sources, input video, or free-run (internal clock) video sync. Selectable failover allows alternate reference selection should the initial reference source become unavailable or invalid. In the event of input video loss of signal, the output can be set to disable video, go to black, go to an internal test signal generator pattern, or freeze to the last intact frame (last frame having valid SAV and EAV codes).

An internal test signal generator provides a selection of 10 standard patterns such as color bars, sweep patterns, and other technical patterns. The generator output can be invoked upon loss of program video input, or applied to the program video output via user controls.

Timecode Processor

(See Figure 1-3.) This function uses extracted timecode data from the input video (waveform or ATC), reference VITC waveform, or internal (free run) and in turn re-inserts selected timecode data into the program video signal. The function can monitor video input and reference input for supported timecode formats, and then select and prioritize among SDI VITC waveform, SDI ATC_VITC, and SDI ATC_LTC timecode sources. If the preferred format is detected, the preferred format is used by the card; if the preferred format is not detected, the card uses other formats (where available) as desired.

The function also provides conversion between various timecode formats and provides independent insertion and line number controls for each SDI timecode output format.

Option  When licensed with option **+LTC**, this function also can receive, send and translate between audio/RS-485 LTC timecode formats and the VBI formats described above. Refer to catalog or Fusion3G® manual supplement OPT-F3GLTC-MS for more information.

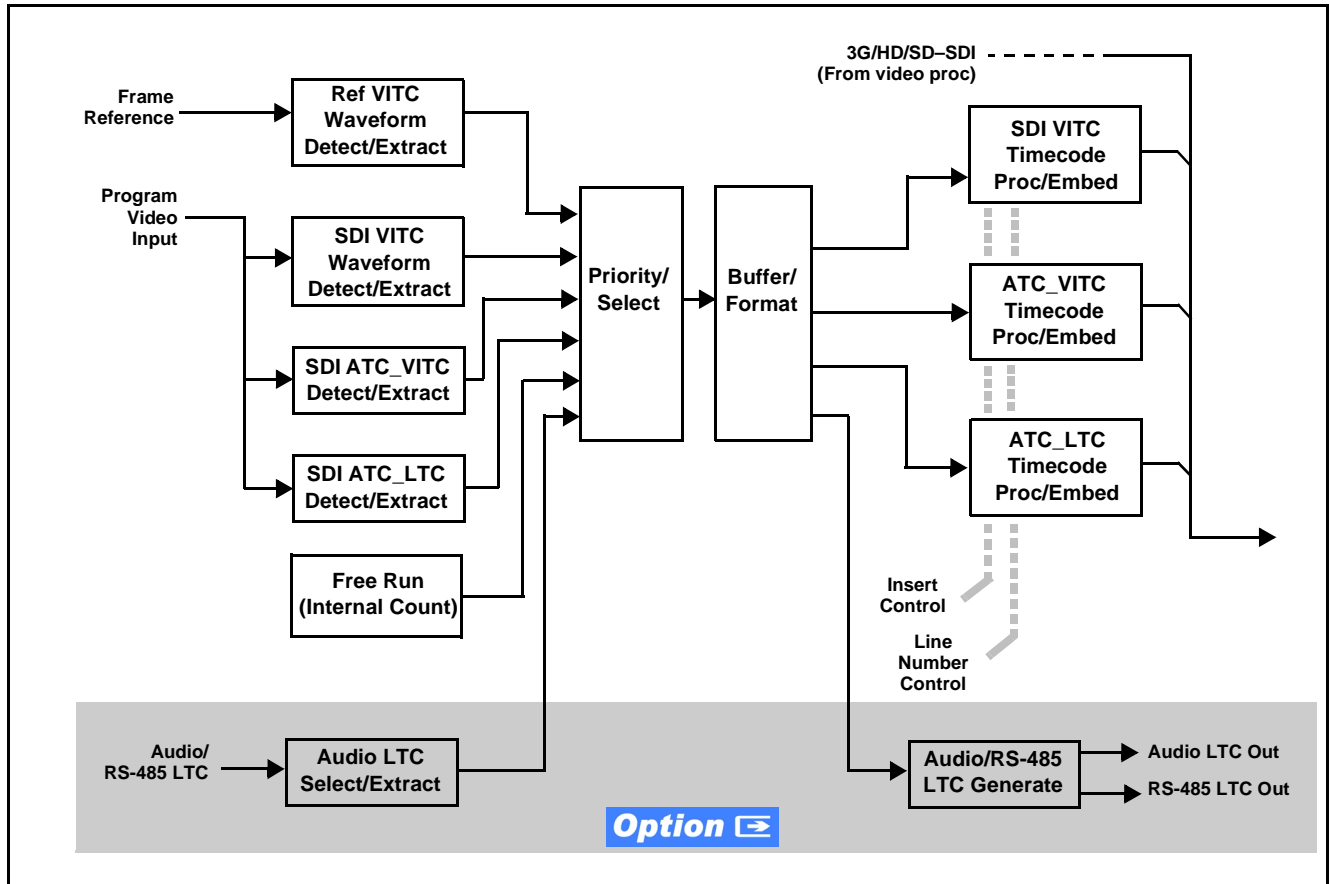

Figure 1-3 Timecode Processor

ARC Processor

(See Figure 1-3.) This function uses extracted Aspect Ratio Control (ARC) data from the input video (in either AFD, WSS, or VI formats) and provides:

- Format translation between AFD, WSS, and VI ARC formats.
- H/V cross-conversion matrix in which a received code directs a same or other user-selectable alternate H/V ratio on the output for any of several H/V ratios.

The input video is checked for ARC formats and can be set to provide a trigger upon when a selected ARC format is received, the code associated with the received format can be applied to the output as a translated format (for, example, from WSS to AFD). Received H/V codes can also be applied through an H/V conversion matrix that allows alternate H/V ratios for a given received input code. The ARC code format priority works in that AFD has highest priority, with WSS or VI selectable as the next priority. In conjunction with a user-accessible cross-matrix table, the received code then in turn directs any of several user-selectable H/V settings to be inserted on the output video as AFD, WSS, and/or VI codes. AFD, WSS and/or VI can be rejected for input consideration.

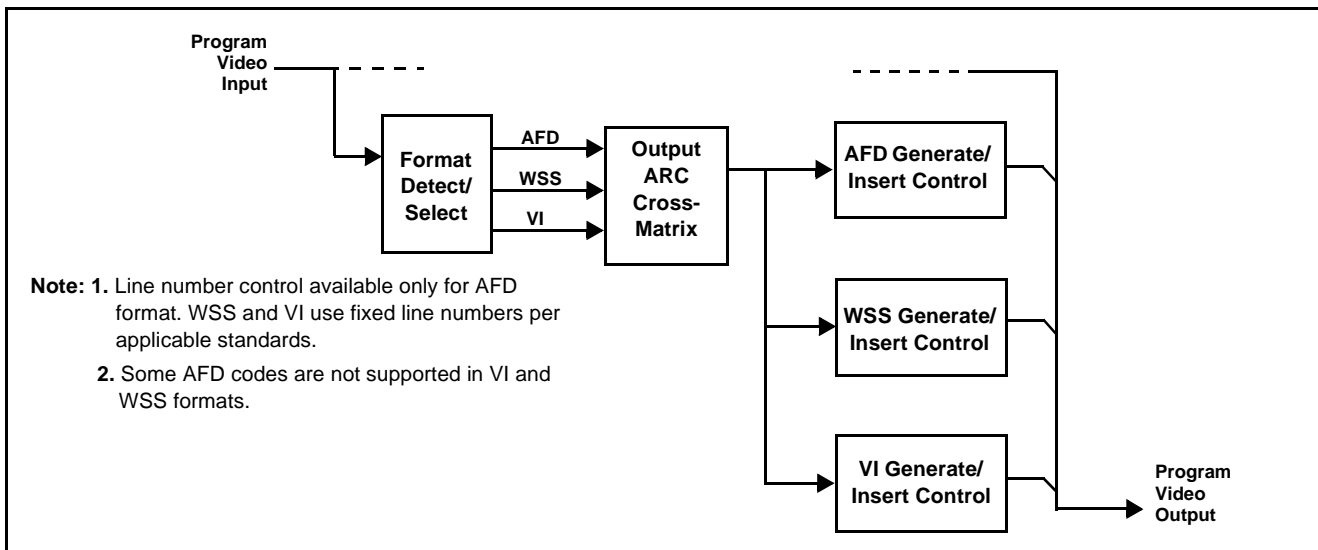

Figure 1-4 ARC Processor

Closed Captioning Processor

This function provides support for closed captioning setup. When enabled, the function allows passage of timecode data. The function also allows the selection of the ancillary data line number where the ancillary closed caption data is outputted when the output is HD.

Audio Subsection Description

Note: Descriptions below include some functions and features that are available only as options.

(See Figure 1-5.) The 9931-EMDE audio processing subsection is built around a card internal 16-channel bus. This 16-channel bus receives inputs from an input routing crosspoint that routes de-embedded and discrete AES signals over the 16-channel bus. Correspondingly, at the output end of the 16-channel bus is an output routing crosspoint that in turn distributes the 16-channel bus signals to embedded and discrete AES audio outputs.

An Input Audio Status display shows the presence and peak level of each input audio channel received by the card. For digital audio inputs, payload is identified (PCM or data such as Dolby® Digital or E), as well as sample rate for discrete AES inputs. Discrete AES inputs can have sample rate conversion applied to align these inputs with the output timing (received sample rates from 32 kHz to 96 kHz are supported).

An Audio DSP function (which interfaces with the output routing block) provides eight tone generators and advanced functions such as loudness processing and upmixing. The routing and Audio DSP functions are described in detail later in this section.

As such, the audio subsection provides a full crosspoint between all supported audio inputs and output formats.

The audio subsection allows choices from the following audio inputs:

- 16 channels of de-embedded audio from the SDI program video path
- Up to 16 channels (8 pairs) of discrete AES input
- Up to 8 channels of balanced analog audio input
- Up to 10 channels of decoded Dolby® E or AC-3 audio
- Digital silence (mute) setting

The audio subsection allows routing to the following audio outputs:

- 16 channels of embedded audio on the SDI output
- Up to 16 channels of discrete AES output on eight AES pairs
- Up to 8 channels of balanced analog audio output

Note: Practical AES channel count handled by the card is 8 pairs, of which each pair can be user GUI-selectable as an input or output.

All embedded and AES channels have status displays that show the following for each channel pair:

- PCM signal presence
- Dolby E signal presence
- Dolby Digital signal presence
- Missing (no signal detected)

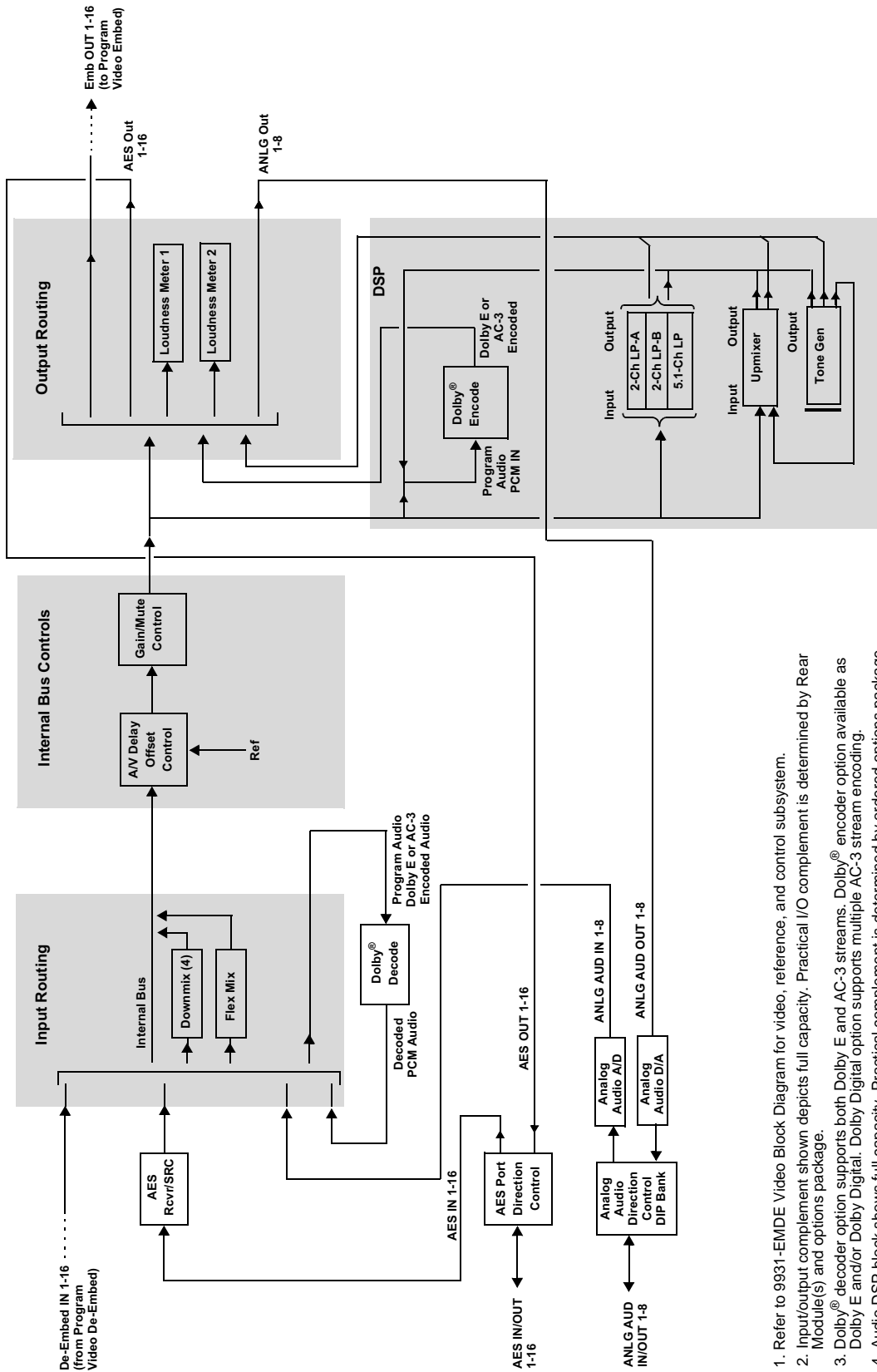

PROXRUIX_AUD 0911

- Notes:**
1. Refer to 9931-EMDE Video Block Diagram for video, reference, and control subsystem.
 2. Input/output complement shown depicts full capacity. Practical I/O complement is determined by Rear Module(s) and options package.
 3. Dolby® decoder option supports both Dolby E and AC-3 streams. Dolby® encoder option available as Dolby E and/or Dolby Digital. Dolby Digital option supports multiple AC-3 stream encoding.
 4. Audio DSP block shows full capacity. Practical complement is determined by ordered options package. LP=Loudness Processor; LM=Loudness Meter; Tone Gen=Tone Generators.

Figure 1-5 9931-EMDE Audio Block Diagram

Embedded, AES, and analog input channel pairs also have displays showing slow-ballistics true peak levels for each pair. Embedded and AES channels at digital silence signal level show Mute; analog channels with levels below -96 dBFS digital equivalent show Silence.

Output audio rates are always 48 kHz locked to output video, but discrete AES inputs can pass through the sample rate converters to align these inputs with the output timing. Output AES is always precisely synchronized with the output video. The balanced analog audio input is sampled at 48 kHz with a +24 dBu clipping level (+24 dBu => 0 dBFS).

Note: AES Dolby-encoded inputs routed directly to card optional Dolby decoder are detected and use a special path that automatically bypasses SRC.

Audio Input Routing/Mixing Function

(See Figure 1-5.) The input routing function provides gain and mute controls for each input signal. Following these controls, selected inputs can directly exit the input routing function and be applied to the internal bus, or first be applied to one of four downmixers or flex mixers.

Downmixers. (See Figure 1-6.) Four independent downmixers (**Downmix-A** thru **Downmix-D**) provides for the selection of any five embedded, AES discrete, Dolby[®] decoded, or analog audio sources serving as Left (**L**), Right (**R**), Center (**C**), Left Surround (**Ls**), and Right Surround (**Rs**) individual signals to be multiplexed into a stereo pair. The resulting stereo pairs **Downmix-A(L/R)** thru **Downmix-D(L/R)** can in turn be routed and processed just like any of the other audio sources described earlier.

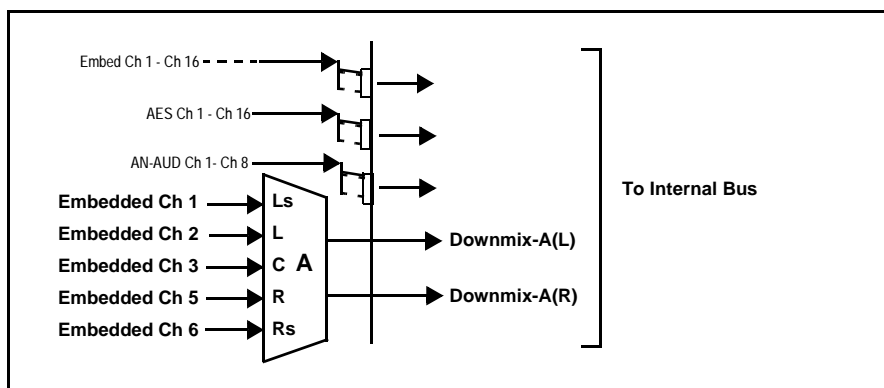



Figure 1-6 Downmixing Functional Block Diagram with Example Sources

Automatic Downmixer. **Option**  Automatic downmixing (option +ADM) allows monitoring a selected stereo pair for a user-configurable signal level threshold. If this threshold is not achieved within a configurable holdoff time, the automatic downmixing develops a stereo downmix from selected alternate multi-channel sources (developing an automatic downmix as described for Downmixers above).

Flex Mixer. The flex mixer is a flexible-structure mixer in which any of 16 summing nodes (**Flex Mix Bus A** thru **Flex Mix Bus P**) can be applied to any of the 16 inputs, thereby allowing several customizable mixing schemes. Any individual input row can be assigned to any of the Flex Mix buses.

Using this scheme, full cross-point mixing of PCM signals can be achieved within the limit of available Flex Mix buses, and eventually applied to any of the internal bus channels. Figure 1-7 shows an example of two independent 3-to-1 mono mixers available by setting inputs (rows) 1 thru 3 to use virtual flex mix bus **Flex Mix Bus A**, and by setting inputs 4 thru 6 to use virtual flex mix bus **Flex Mix Bus B**. The **Flex Mix A** and **Flex Mix B** virtual outputs can then be routed over any of the internal bus channels. In this example, because rows 1 thru 3 are all applied in common to mixer node **Flex Mix Bus A**, the **Flex Mix Bus A** output is the mono-mixed sum of these inputs. The mono mix on the **Flex Mix Bus B** node similarly produces a mono mix of input rows 4 thru 6.

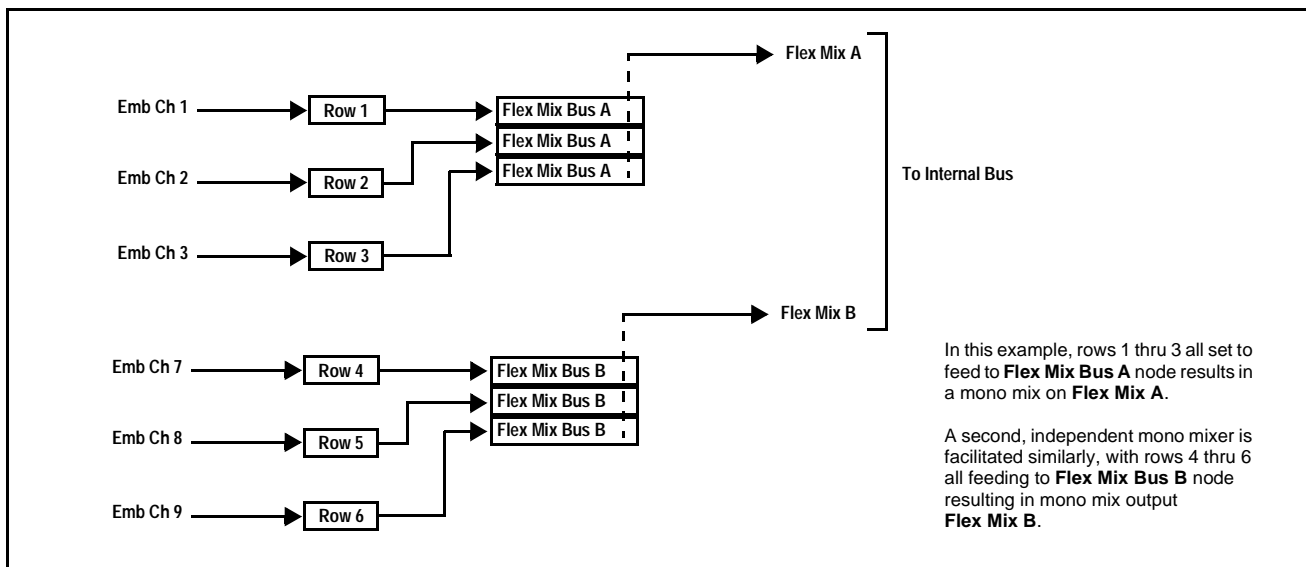

Figure 1-7 Flex Mixer with Dual Mono Mixer Example

Internal Bus

(See Figure 1-5.) The internal bus receives its audio inputs from the input routing function and accommodates a maximum of 16 concurrent channels. This conduit serves as a centralized point for managing audio delay offset from video and master gain controls for outputs from the input routing function.

A bulk (master) video/audio delay function allows adding or reducing audio delay from the video delay. The 9931-EMDE re-establishes video/audio sync following framesync changes by applying an offset in small, progressive amounts to provide a seamless, glitch-free retiming.

In addition to the master sync/delay controls, each bus channel has its own independent delay and gain control.

As shown in Figure 1-5, the internal bus receives inputs directly from card external sources or Dolby® decoder outputs as listed below.

- Emb Ch 1-16
- AES Ch 1-16
- Analog audio Ch 1 - 8
- Dolby® decode Ch 1-10
- Silence

Automatic Audio Failover. **Option**  Automatic audio failover (option **+AFO**) allows monitoring each of the card's internal bus channels for a user-configurable signal level threshold. If this threshold is not achieved within a configurable holdoff time, the failover function allows an alternate (“secondary”) channel to substitute for the primary channel.

Audio Output Routing Function

(See Figure 1-5.) The output routing function provides routing to card outputs. This function can also direct internal bus signals to further mixing capabilities or advanced Audio DSP functions. This function also provides gain and mute controls for each signal.

Audio DSP functions include 5.1-channel and stereo loudness processing, and upmixing.

Audio DSP Functions Overview. The Audio DSP block provides the function complement (selected via user controls) listed below. Because this block is entirely software-based, it can provide the Audio DSP combinations listed below (depending on ordered options).

- 5.1-Ch Loudness Processor + Dual Stereo Loudness Processors
- Dual 5.1-Ch Loudness Processors
- 5.1-Ch Loudness Processor + Upmixer
- Dual Stereo Loudness Processors + Dual Stereo Loudness Processors
- Dual Stereo Loudness Processors + Upmixer
- Dual Upmixers

2.0-to-5.1 Upmixer. **Option**  The 2.0-to-5.1 upmixer function receives a normal PCM stereo pair from any internal bus channel pair. The stereo pair is upmixed to provide 5.1 channels (Left (**L**), Right (**R**), Center (**C**), Low Frequency Effects (**LFE**), Left Surround (**Ls**), and Right Surround (**Rs**)). Whenever the upmixer is active, it overwrites the six selected 5.1 output channels with the new 5.1 upmix signals (including replacing the original source stereo **L** and **R** inputs with new **L** and **R** signals).

The 2.0-to-5.1 upmixer can be set to upmix in any of three modes: Always upmix, Bypass upmix, or Auto enable/bypass upmixing. The Auto upmixing mode looks at the signal levels on the selected channels and compares them to a selectable level threshold. It then determines whether or not to generate 5.1 upmixing from the stereo pair as follows:

- If the upmixer detects signal level **below** a selected threshold on **all three** of the selected channels designated as **C**, **Ls**, and **Rs**, this indicates to the upmixer that these channels are not carrying 5.1. In this case, the upmixer produces new 5.1 content generated by the upmixer.
- If the upmixer detects signal level **above** a selected threshold on **any** of the three selected channels designated as **C**, **Ls**, and **Rs**, this indicates to the upmixer that the channel(s) are already carrying viable 5.1 content. In this case, the upmixer is bypassed and the channels fed to the upmixer pass unaffected to the upmixer outputs.

The examples in Figure 1-8 show the automatic enable/disable upmixing function applied to example selected channels **Bus Ch 1** thru **Bus Ch 6**. As shown and described, the processing is contingent upon the signal levels of the channels selected to carry the new 5.1 upmix relative to the selected threshold (in this example, -60 dBFS).

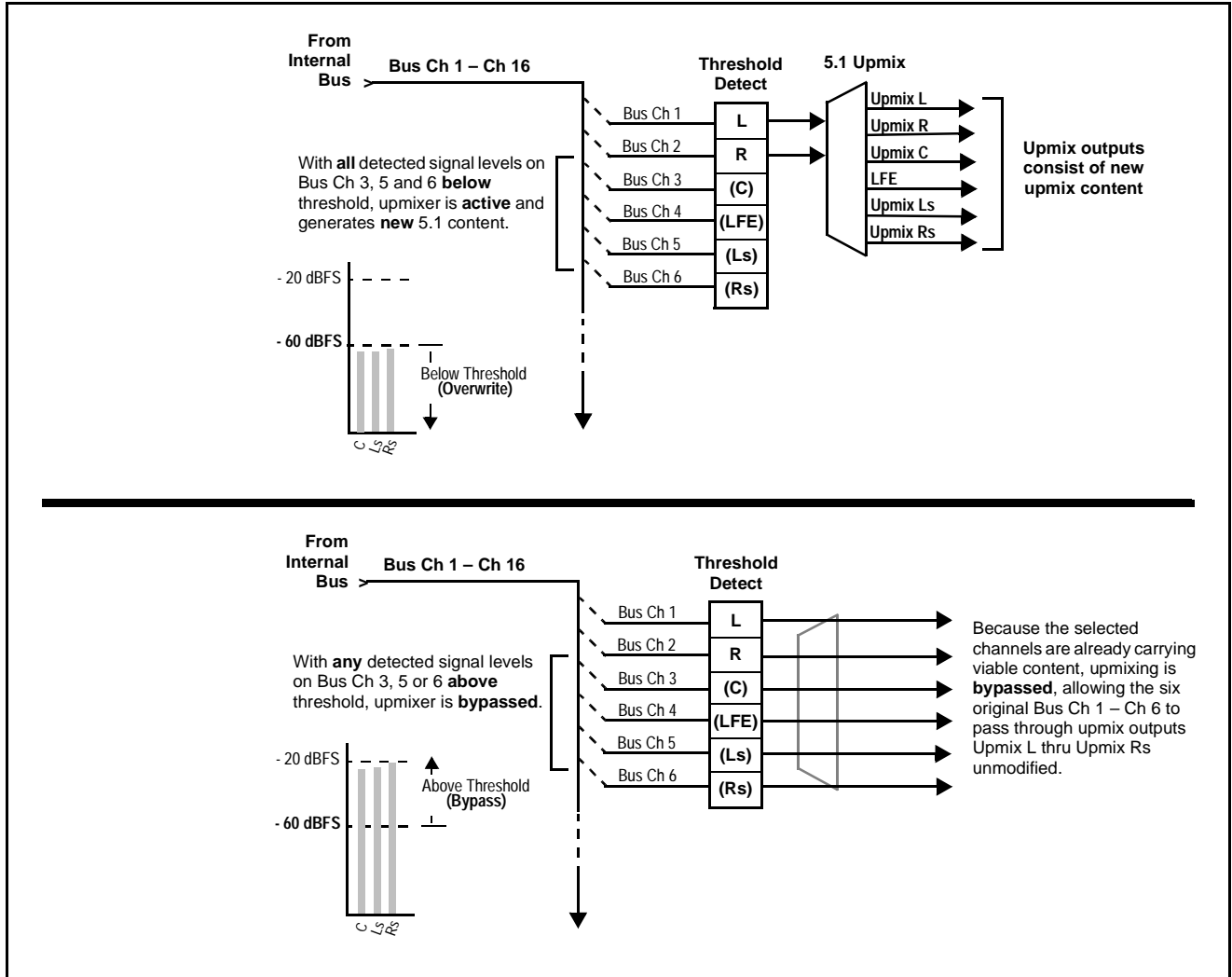



Figure 1-8 Upmixing Auto Enable/By-pass with Example Sources

Loudness Processor. **Option**  (See Figure 1-9.) The loudness processor function receives up to six selected channels from the internal bus and performs loudness processing on the selected channels. A loudness processing profile best suited for the program material can be selected from several loudness processing presets. Refer to catalog or Fusion3G® manual supplement OPT-SW-F3GLP-MS for more information.

Note: Discussion and example here describes 5.1-channel loudness processor. Stereo and dual-stereo processors operate similar to described here.

The example in Figure 1-9 shows routing of embedded output channels Emb Out Ch 1 thru Ch 6 fed through the loudness processor. A master output gain control is provided which allows fine adjustment of the overall output level.

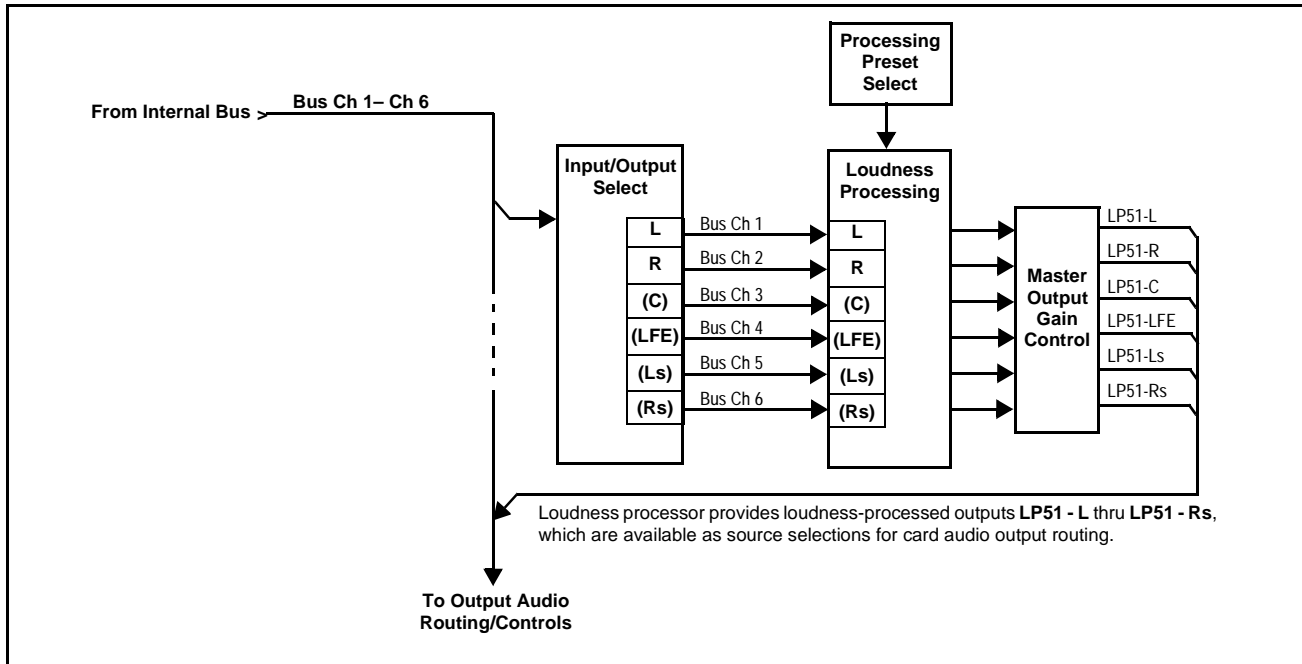

Figure 1-9 5.1-Channel Loudness Processor with Example Sources

Tone Generators. The 9931-EMDE contains eight built-in tone generators of frequencies from 50 Hz to 16 kHz. Each of the eight tone generators can be routed to the upmixer or directly to card audio outputs. (Default output is -20 dBFS.)

DashBoard Dual Audio Loudness Meter

Description. [Option](#)

Note: This function provides DashBoard loudness metering and is typically furnished with cards licensed for loudness processing. OGCP-9000 Loudness Meter Option (+LM) is an OGCP-9000 Control Panel option that provides advanced loudness metering functions such as graphing and statistics. +LM option is separate and independent of this function; refer to catalog or website for more information.

This function allows two independent 5.1-channel PCM groups to be routed to two independent DashBoard loudness meters that provide short-term loudness measurement in accordance with ITU-R BS.1770-1 – ATSC A/85.

The function can monitor any combination of channels on the card internal bus, or audio DSP output channels such as upmixed and loudness-processed channels (channel routing to the meters is independent of any other card routing and does not affect the channels in any way). The two loudness meters readily allow pre and post-processed loudness processing comparison when loudness processing is being performed by the card.

The function provides a configurable short term window for tailoring the measurement to suit various program material conditions.

Control and Data Input/Output Interfaces

GPI Interface

Two independent ground-closure sensing GPI inputs (**GPI 1** and **GPI 2**; each sharing common ground connection as chassis potential) are available. Associated with each GPI user control is a selection of one of 64 user-defined card presets in which GPI activation invokes a card control preset. Because the GPI closure invokes a user-defined preset, the resulting setup is highly flexible and totally user-defined. Invoking a user preset to effect a change involves card setup communication limited **only** to the items being changed; the card remains on-line during the setup, and the called preset is rapidly applied.

GPI triggering can be user selected to consider the activity on discrete GPI ports, or combinations of logic states considering both GPI inputs. This flexibility allows multistage, progressive actions to be invoked if desired. Indication is provided showing whenever a GPI input has been invoked.

GPO Interface

Two independent SPST NO electromechanical non-referenced (floating) contact pairs (**GPO 1/1** and **GPO 2/2**) are available. A GPO can be invoked by setting a GPO to be enabled when a card preset is in turn applied (i.e., when a preset is invoked (either manually or via event-based loading), the GPO is correspondingly also activated.

Serial (COMM) Ports

The 9931-EMDE is equipped with two, 3-wire serial ports (**COM 1 - Serial Port 1**, **COM 2 - Serial Port 2**). The ports allow serial metadata import and export between optional Dolby® encoders and decoders. The ports also provide for SMPTE 2020 de-embedding to an output port, and provide RS-485 LTC I/O (when licensed with option +LTC).

User Control Interface

Figure 1-10 shows the user control interface options for the 9931-EMDE. These interfaces are individually described below.

Note: All user control interfaces described here are cross-compatible and can operate together as desired. Where applicable, any control setting change made using a particular user interface is reflected on any other connected interface.

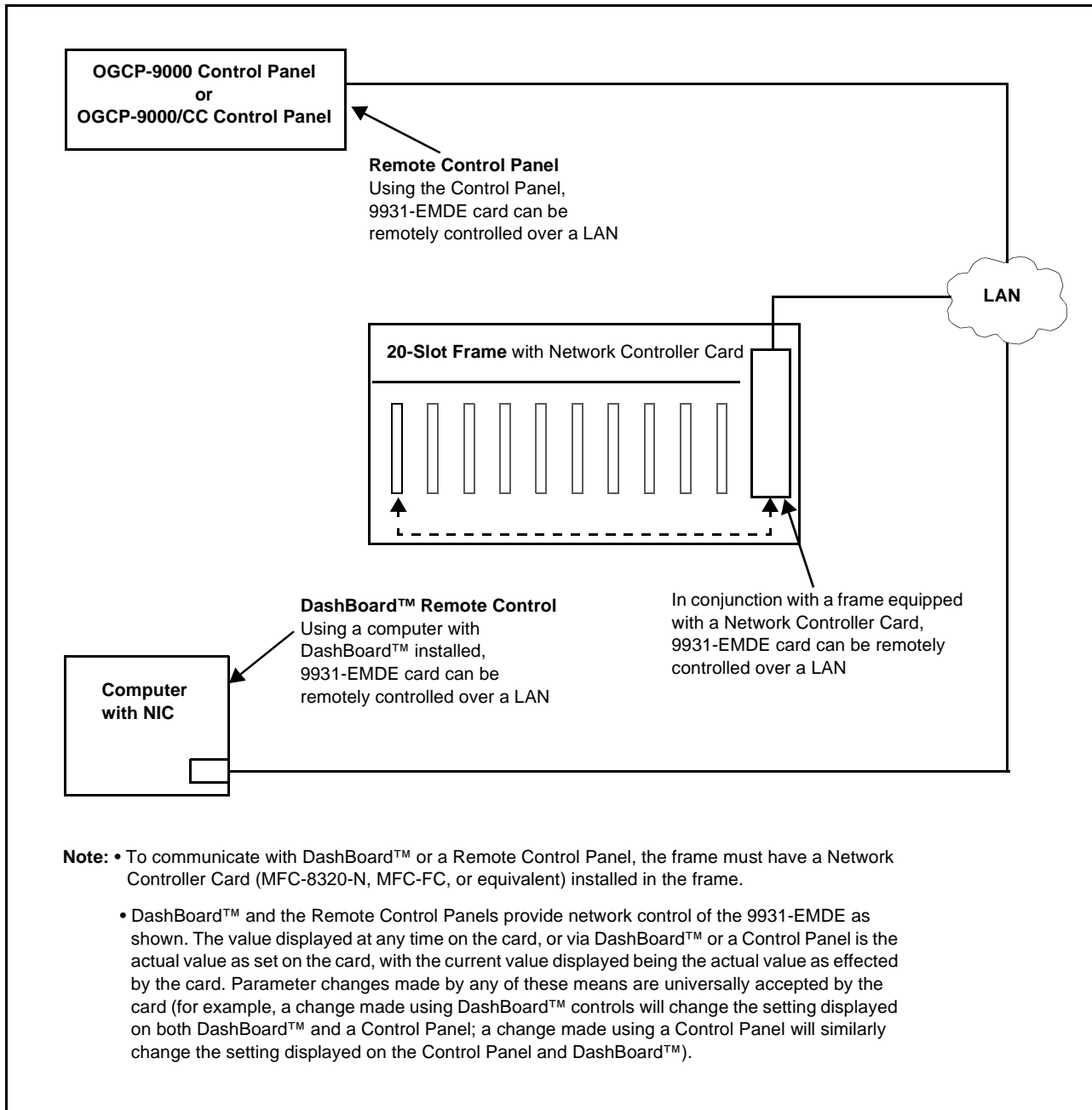

Figure 1-10 9931-EMDE User Control Interface

- **DashBoard™ User Interface** – Using DashBoard™, the 9931-EMDE and other cards installed in openGear®¹ frames such as the Cobalt® HPF-9000 or 8321 Frame can be controlled from a computer and monitor.

DashBoard™ allows users to view all frames on a network with control and monitoring for all populated slots inside a frame. This simplifies the setup and use of numerous modules in a large installation and offers the ability to centralize monitoring. Cards define their controllable parameters to DashBoard™, so the control interface is always up to date.

The DashBoard™ software can be downloaded from the Cobalt Digital Inc. website: www.cobaltdigital.com (enter “DashBoard” in the search window). The DashBoard™ user interface is described in Chapter 3, “Operating Instructions”.

Note: If network remote control is to be used for the frame and the frame has not yet been set up for remote control, Cobalt® reference guide **Remote Control User Guide (PN 9000RCS-RM)** provides thorough information and step-by-step instructions for setting up network remote control of COMPASS® and FUSION3G® cards using DashBoard™. (Cobalt® OGCP-9000 and OGCP-9000/CC Remote Control Panel product manuals have complete instructions for setting up remote control using a Remote Control Panel.)

Download a copy of this guide by clicking on the **Support>Documents>Reference Guides** link at www.cobaltdigital.com and then select DashBoard Remote Control Setup Guide as a download, or contact Cobalt® as listed in Contact Cobalt Digital Inc. (p. 1-32).

- **Cobalt® OGCP-9000 and OGCP-9000/CC Remote Control Panels** – The OGCP-9000, OGCP-9000/CC, and WinOGCP Remote Control Panels conveniently and intuitively provide parameter monitor and control of the cards within the 20-slot frame.

The remote control panels allow quick and intuitive access to hundreds of cards in a facility, and can monitor and allow adjustment of multiple parameters at one time.

The remote control panels are totally compatible with the openGear® control software DashBoard™; any changes made with either system are reflected on the other.

1. openGear® is a registered trademark of Ross Video Limited. DashBoard™ is a trademark of Ross Video Limited.

9931-EMDE Rear Modules

The 9931-EMDE physically interfaces to system video and audio connections using a Rear Module. Figure 1-11 shows a typical 9931-EMDE Rear Module.

All inputs and outputs shown in the video and audio block diagrams (Figures 1-2 and 1-5, respectively) enter and exit the card via the card edge backplane connector. The Rear Module breaks out the 9931-EMDE card edge connections to industry standard connections that interface with other components and systems in the signal chain.

In this manner, the particular inputs and outputs required for a particular application can be accommodated using a Rear Module that best suits the requirements. The required input and outputs are broken out to the industry standard connectors on the Rear Module; the unused inputs and outputs remain unterminated and not available for use.

The full assortment of 9931-EMDE Rear Modules is shown and described in 9931-EMDE Rear Modules (p. 2-7) in Chapter 2, “Installation and Setup”.

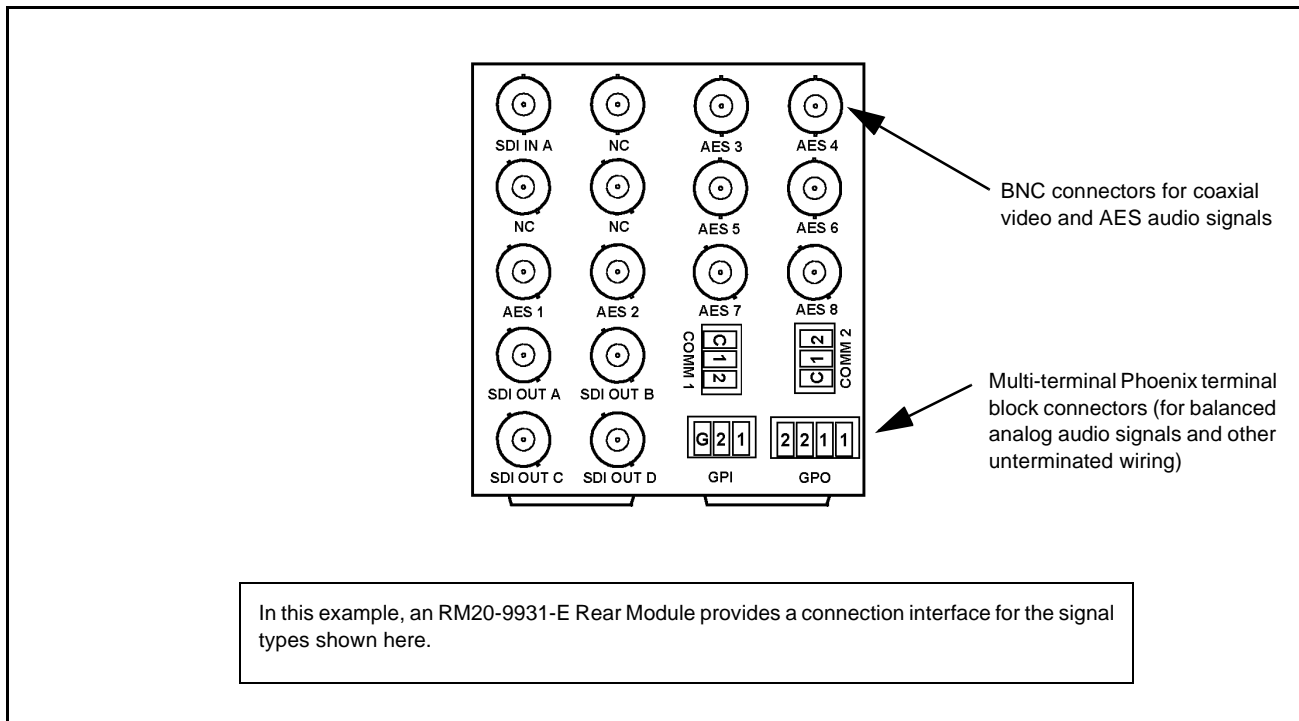

Figure 1-11 Typical 9931-EMDE Rear Module

For some card options, a piggyback card is mounted to the main 9931-EMDE card. Occupying two card slots, the connections for the functions offered by the piggyback card are broken out using an expansion module (which is installed adjacent to the base card rear module slot). When an expansion rear module is used, the base rear module mates with the base Fusion3G® card, and the expansion rear module mates with the expansion piggyback card that is piggyback-installed on the base card.

Figure 1-12 shows a 9931-EMDE card using an RM20-9931-B base rear module along with an analog audio expansion rear module.

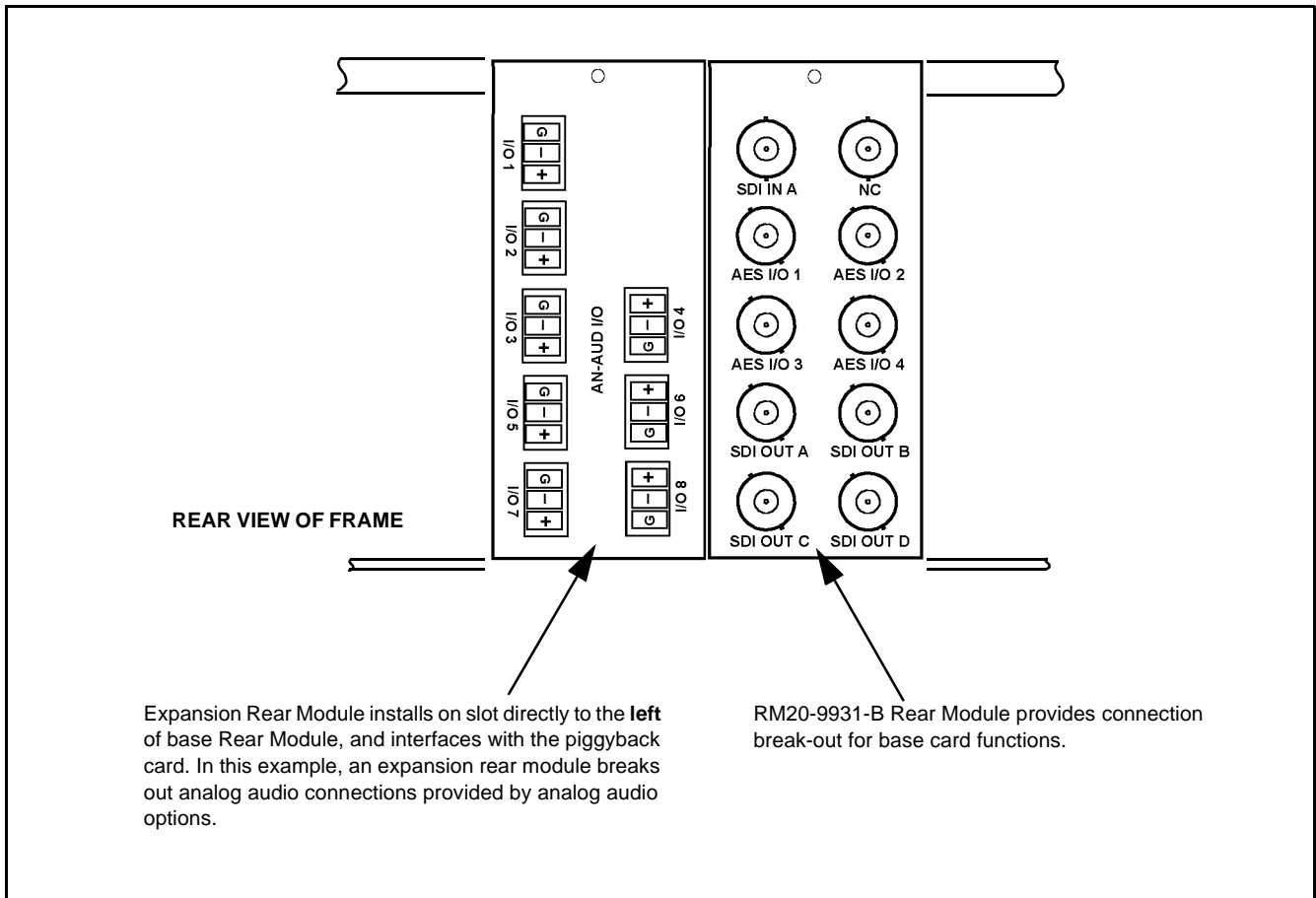

Figure 1-12 9931-EMDE with Expansion Rear Module

Audio and Video Formats Supported by the 9931-EMDE

Table 1-3 lists and provides details regarding the audio and video formats supported by the 9931-EMDE.

Table 1-3 Supported Audio and Video Formats

Item	Description/Specification	
Input / Output Video	Raster Structure:	Frame Rate:
	1080p	23.98; 24; 29.97; 25; 30
	1080p 3G ⁽²⁾	50; 59.94; 60
	1080i ⁽¹⁾	25; 29.97; 30
	720p	23.98; 24; 25; 29.97; 30; 50; 59.94; 60
	486i ⁽¹⁾	29.97
	575i ⁽¹⁾	25
Embedded Audio	The 9931-EMDE supports all four groups (16 channels) of embedded audio at full 24-bit resolution in both SD (with extended data packets) and HD.	
Analog Audio	The 9931-EMDE supports 8 channels of balanced (differential) analog audio (maximum total of inputs and outputs). The analog audio is encoded such that a +24 dBu input is equivalent to digital 0 dBFS.	
Discrete AES Audio	The 9931-EMDE can accept 16 channels (8 pairs) of discrete AES audio on 75Ω BNC connections (maximum total of inputs and outputs). Sample rate conversion can be employed to accommodate sample rate differences in the AES stream and the input video stream.	
(1) All rates displayed as frame rates; interlaced (“i”) field rates are two times the rate value shown.		
(2) Not supported as analog video I/O formats.		

Technical Specifications

Table 1-4 lists the technical specifications for the 9931-EMDE 3G/HD/SD-SDI Embedder/De-Embedder card.

Note: Input/output types and number of input/outputs in some cases are a function of option(s) and/or rear module installed. Input/outputs requiring options are specified below. Refer to Table 1-1, “9931-EMDE Video/Audio Signal Types” for detailed information on available input/output complements and corresponding options/rear module requirements.

Table 1-4 Technical Specifications

Item	Characteristic
Part number, nomenclature	<ul style="list-style-type: none"> • 9931-EMDE 3G/HD/SD-SDI Embedder/De-Embedder • 9931-EM 3G/HD/SD-SDI Embedder • 9931-DE 3G/HD/SD-SDI De-Embedder
Installation/usage environment	Intended for installation and usage in frame meeting openGear [®] modular system definition.
Power consumption	28 Watts (nominal) The following options add power consumption as follows: <ul style="list-style-type: none"> • +DEC (Dolby[®] decoder) option: 2 Watts • +ANA, +ANV (analog audio/video I/O) options: 15 Watts (typical)
Environmental: Operating temperature: Relative humidity (operating or storage):	32° – 104° F (0° – 40° C) < 95%, non-condensing
Frame communication	10/100 Mbps Ethernet with Auto-MDIX.
Internal Tone Generators	Eight built-in tone generators, each configurable for 18 discrete sine wave frequencies ranging from 50 Hz to 16 kHz. Generator source signal level is equivalent to -20 dBu.
Standards Supported (SDI)	3G: SMPTE 425 level A 1080p60, 1080p59.94, 1080p50 HD: 1080i60, 1080i59.94, 1080i50, 1080p29.97, 1080p25, 1080p24; 1080p23.98 720p60, 720p59.94, 720p50, 720p29.97, 720p25, 720p24, 720p23.98 SD: 486i59094, 576i50
BNC SDI Video Inputs/Outputs	Input/Output Complement: <ul style="list-style-type: none"> • One BNC input connector • Four BNC output connectors Data Rates Supported: <ul style="list-style-type: none"> SMPTE 425 level A and B: 3 Gbps SMPTE 292 HD-SDI: 1.485 Gbps or 1.485/1.001 Gbps SMPTE 259M-C SD-SDI: 270 Mbps BNC Connector Input/Output Impedance: <ul style="list-style-type: none"> 75 Ω terminating Cable Equalization (3G): <ul style="list-style-type: none"> 394 ft (120 m) Belden 1694A Cable Equalization (HD): <ul style="list-style-type: none"> 591 ft (180 m) Belden 1694A Cable Equalization (SD): <ul style="list-style-type: none"> 1050 ft (320 m) Belden 1694A Return Loss: <ul style="list-style-type: none"> > 15 dB up to 1.485 GHz

Table 1-4 Technical Specifications — continued

Item	Characteristic
Fiber Inputs/Outputs (option required)	Input/Output Complement: Up to two inputs/outputs (maximum total between inputs and outputs) Connectors: Dual LC, standard polish Fiber Type: 9/125 micron, single mode Mating System: Blindmate Tx Power: -5 dBm @ 1310 nm Rx Power: -16 to -3 dBm @ 1260 to 1620 nm
Analog Video Input (option required)	Input Complement: Separate component and composite inputs on 75 Ω BNC connectors. Supports component HD/SD and component, composite, and Y/C SD inputs. Video Input Types: HD: Component YPbPr and RGB SMPTE SD: Composite, Component YPbPr (BetaCam™, MII™, SMPTE/N10), RGB, and Y/C ADC Bit Depth: 12 bit Sampling: 54 MHz (4x oversampling) Frequency Response: Y/CVBS: ± 0.25 dB to 30 MHz Pb/Pr: ± 0.25 dB to 15 MHz Noise: < -60 dB to 30 MHz (unweighted) Differential Phase: <1.5° Differential Gain: <1.0%
Analog Video Output (option required)	Output Complement: Separate component and composite outputs on 75 Ω BNC connectors. Supports component HD/SD and component, composite, and Y/C SD outputs. Video Output Types: HD: Component YPbPr and RGB SMPTE SD: Composite, Component YPbPr (BetaCam™, MII™, SMPTE/N10), RGB, and Y/C

Table 1-4 Technical Specifications — continued

Item	Characteristic
Analog Video Output (option required) (cont.)	DAC Bit Depth: 12 bit Frequency Response: Y/CVBS: ± 0.25 dB to 30 MHz Pb/Pr: ± 0.25 dB to 15 MHz Noise: < -60 dB to 30 MHz (unweighted) Differential Phase: <1.5° Differential Gain: <1.0%
AES Audio Inputs/Outputs	Standard: SMPTE 276M Number of inputs/outputs (maximum total between inputs and outputs): 8 pairs (16-channel) on BNC connectors per AES3-id; 75 Ω impedance Input Level: 0.2 to 2.0 Vp-p Output Level: 1.0 Vp-p Return Loss: > 15 dB @ up to 6.144 MHz Input SRC Range: 32 kHz to 96 kHz Input SRC Performance: >130 dB THD+N
Analog Audio Inputs/Outputs (option required)	Number of inputs/outputs (maximum total between inputs and outputs): Eight, 3-wire balanced analog audio using Phoenix connectors with removable screw terminal blocks (Phoenix PN 1803581; Cobalt PN 5000-0013-000R) Input Impedance: >10 k Ω Input Clip Level: +24 dBu (eq. 0 dBFS) Max. Output Level: +24 dBu (eq. 0 dBFS) Frequency Response: ± 0.12 dB (20 Hz to 20 kHz) SNR: 115 dB (A-weighted) THD+N: -96 dB (20 Hz to 10 kHz) Crosstalk: -106 dB (20 Hz to 20 kHz)
Audio Delay	Configurable Audio Delay: 16-channel; independent delay per channel; 1 sample step size Up to 5 sec delay for each channel

Table 1-4 Technical Specifications — continued

Item	Characteristic
Serial Ports	<p>Two ports, each 3-wire RS-485 using Phoenix connectors with removable screw terminal blocks (Phoenix PN 1803581; Cobalt PN 5000-0013-000R)</p> <p>Rx Functions: Closed captioning input, Dolby® metadata input, RS-485 LTC IN</p> <p>Tx Functions: Closed captioning output, Dolby® metadata output, RS-485 LTC OUT</p>
GPI Ports	<p>Two opto-isolated ports with self-sourcing current on 3-wire (IN 1, IN 2, GND) Phoenix connector with removable screw terminal blocks (Phoenix PN 1803581; Cobalt PN 5000-0013-000R)</p> <p>Triggering: User-configurable. GPI activation invokes a selected user preset.</p> <p>Response: GPI acknowledge upon falling-edge input triggered by $R \leq 10 \text{ k}\Omega$ (or $V_{in} \leq 2.0 \text{ V}$) GPI release upon rising-edge input triggered by $R \geq 10 \text{ k}\Omega$ (or $V_{in} \geq 2.0 \text{ V}$) "G" (GND) terminal at chassis-ground potential Suitable for use with 3.3V LVCMOS logic</p> <p>Maximum Recommended Logic Control Voltage Range: 0 to 5 VDC</p>
GPO Ports	<p>Two, independent non-referenced (floating) SPST relay closure indicating input path selected (either via manual or failover selection). GPO can be selected to trigger upon engagement of a specified user preset.</p> <p>Response: Closure effected for duration of true status condition; closure release upon false status condition</p> <p>Maximum Recommended Voltage / Current: 12 VDC @ 100mA max.</p> <p>Connector: 4-terminal Phoenix; GPO1/GPO1C / GPO2/GPO2C</p>

Warranty and Service Information

Cobalt Digital Inc. Limited Warranty

This product is warranted to be free from defects in material and workmanship for a period of five (5) years from the date of shipment to the original purchaser, except that 4000, 5000, 6000, 8000 series power supplies, and Dolby® modules (where applicable) are warranted to be free from defects in material and workmanship for a period of one (1) year.

Cobalt Digital Inc.'s ("Cobalt") sole obligation under this warranty shall be limited to, at its option, (i) the repair or (ii) replacement of the product, and the determination of whether a defect is covered under this limited warranty shall be made at the sole discretion of Cobalt.

This limited warranty applies only to the original end-purchaser of the product, and is not assignable or transferrable therefrom. This warranty is limited to defects in material and workmanship, and shall not apply to acts of God, accidents, or negligence on behalf of the purchaser, and shall be voided upon the misuse, abuse, alteration, or modification of the product. Only Cobalt authorized factory representatives are authorized to make repairs to the product, and any unauthorized attempt to repair this product shall immediately void the warranty. Please contact Cobalt Technical Support for more information.

To facilitate the resolution of warranty related issues, Cobalt recommends registering the product by completing and returning a product registration form. In the event of a warrantable defect, the purchaser shall notify Cobalt with a description of the problem, and Cobalt shall provide the purchaser with a Return Material Authorization ("RMA"). For return, defective products should be double boxed, and sufficiently protected, in the original packaging, or equivalent, and shipped to the Cobalt Factory Service Center, postage prepaid and insured for the purchase price. The purchaser should include the RMA number, description of the problem encountered, date purchased, name of dealer purchased from, and serial number with the shipment.

Cobalt Digital Inc. Factory Service Center

2506 Galen Drive

Champaign, IL 61821 USA

www.cobaltdigital.com

Office: (217) 344-1243

Fax: (217) 344-1245

Email: info@cobaltdigital.com

THIS LIMITED WARRANTY IS EXPRESSLY IN LIEU OF ALL OTHER WARRANTIES EXPRESSED OR IMPLIED, INCLUDING THE WARRANTIES OF MERCHANTABILITY AND FITNESS FOR A PARTICULAR PURPOSE AND OF ALL OTHER OBLIGATIONS OR LIABILITIES ON COBALT'S PART. ANY SOFTWARE PROVIDED WITH, OR FOR USE WITH, THE PRODUCT IS PROVIDED "AS IS." THE BUYER OF THE PRODUCT ACKNOWLEDGES THAT NO OTHER REPRESENTATIONS WERE MADE OR RELIED UPON WITH RESPECT TO THE QUALITY AND FUNCTION OF THE GOODS HEREIN SOLD. COBALT PRODUCTS ARE NOT AUTHORIZED FOR USE IN LIFE SUPPORT APPLICATIONS.

COBALT'S LIABILITY, WHETHER IN CONTRACT, TORT, WARRANTY, OR OTHERWISE, IS LIMITED TO THE REPAIR OR REPLACEMENT, AT ITS OPTION, OF ANY DEFECTIVE PRODUCT, AND SHALL IN NO EVENT INCLUDE SPECIAL, INDIRECT, INCIDENTAL, OR CONSEQUENTIAL DAMAGES (INCLUDING LOST PROFITS), EVEN IF IT HAS BEEN ADVISED OF THE POSSIBILITY OF SUCH DAMAGES.

Contact Cobalt Digital Inc.

Feel free to contact our thorough and professional support representatives for any of the following:

- Name and address of your local dealer
- Product information and pricing
- Technical support
- Upcoming trade show information

Phone:	(217) 344-1243
Fax:	(217) 344-1245
Web:	www.cobaltdigital.com
General Information:	info@cobaltdigital.com
Technical Support:	support@cobaltdigital.com

Installation and Setup

Overview

This chapter contains the following information:

- Setting I/O Switches for Analog Audio (1-8) Ports (p. 2-1)
- Installing the 9931-EMDE Into a Frame Slot (p. 2-2)
- Installing a Rear Module (p. 2-4)
- Connecting To Phoenix Terminal Connectors (p. 2-15)
- Setting Up 9931-EMDE Network Remote Control (p. 2-15)

Note: The 9931-EMDE is suitable for installation only in a 20-slot frame (Cobalt® PN HPF-9000, OG3-FR, or 8321-CN or equivalent).

Setting I/O Switches for Analog Audio (1-8) Ports

Notes:

- This procedure is applicable only for 9931-EMDE equipped with analog audio options (for example, option +ANAIO). Refer to catalog or Fusion3G® manual supplement Analog Audio/Video Options OPT-F3GAN-MS for more information.

- All switches are set as **inputs** as factory default.

Analog audio options allow the 9931-EMDE to be used with analog audio inputs and/or outputs. The option provides for eight analog audio channel IN or OUT, with each channel configurable as an input or output using DIP switches S1 thru S8). The switches are located on the option piggyback card.

Note switch S1 thru S8 locations for **AN-AUD I/O 1** thru **AN-AUD I/O 8** shown in Figure 2-1. For port to be used as an **output**, set switch to down position as shown in Figure 2-1.

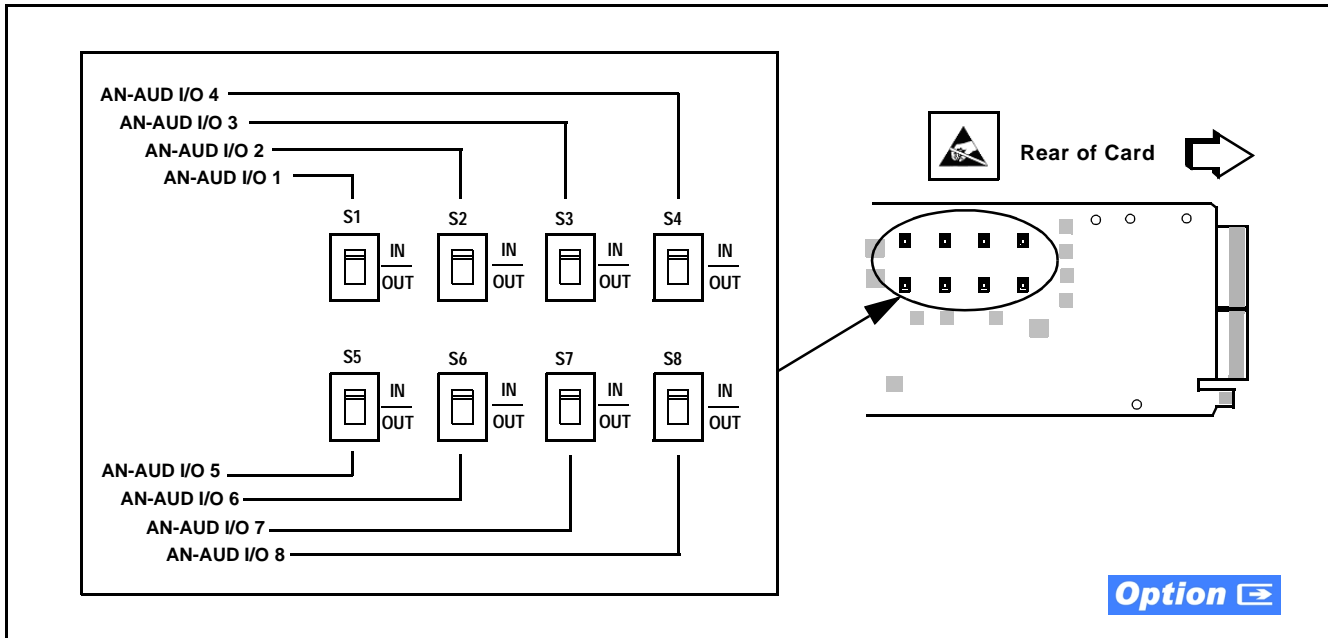

Figure 2-1 9931-EMDE AN-AUD I/O (1-8) Mode Switches

Installing the 9931-EMDE Into a Frame Slot

CAUTION

Heat and power distribution requirements within a frame may dictate specific slot placement of cards. Cards with many heat-producing components should be arranged to avoid areas of excess heat build-up, particularly in frames using only convection cooling. The 9931-EMDE has a moderate power dissipation (20 W max.). As such, avoiding placing the card adjacent to other cards with similar dissipation values if possible.

CAUTION



This device contains semiconductor devices which are susceptible to serious damage from Electrostatic Discharge (ESD). ESD damage may not be immediately apparent and can affect the long-term reliability of the device.

Avoid handling circuit boards in high static environments such as carpeted areas, and when wearing synthetic fiber clothing. Always use proper ESD handling precautions and equipment when working on circuit boards and related equipment.

CAUTION

If required, make certain Rear Module(s) is installed before installing the 9931-EMDE into the frame slot. Damage to card and/or Rear Module can occur if module installation is attempted with card already installed in slot.

- Notes:**
- Check the packaging in which the 9931-EMDE was shipped for any extra items such as a Rear Module connection label. In some cases, this label is shipped with the card and to be installed on the Rear I/O connector bank corresponding to the slot location of the card.
 - Depending on option(s) ordered, the 9931-EMDE unit may consist of a main card and a piggyback option card. If equipped with a piggyback card, **both cards as a unit** will require simultaneous alignment with slot guides and rear modules in the following steps.

Install the 9931-EMDE into a frame slot as follows:

1. Determine the slot in which the 9931-EMDE is to be installed.
2. Open the frame front access panel.
3. While holding the card by the card edges, align the card such that the plastic ejector tab is on the bottom.
4. Align the card with the top and bottom guides of the slot in which the card is being installed.
5. Gradually slide the card into the slot. When resistance is noticed, gently continue pushing the card until its rear printed circuit edge terminals engage fully into the Rear Module mating connector.

CAUTION

If card resists fully engaging in Rear Module mating connector, check for alignment and proper insertion in slot tracks. Damage to card and/or Rear Module may occur if improper card insertion is attempted.

6. Verify that the card is fully engaged in Rear Module mating connector.
7. Close the frame front access panel.
8. Connect cabling in accordance with the appropriate diagram shown in Table 2-1, “9931-EMDE Rear Modules” (p. 2-7).
9. Repeat steps 1 through 8 for other 9931-EMDE cards.

- Notes:**
- The 9931-EMDE BNC inputs are internally 75-ohm terminated. It is not necessary to terminate unused BNC inputs or outputs.
 - To remove a card, press down on the ejector tab to unseat the card from the Rear Module mating connector. Evenly draw the card from its slot.
10. If network remote control is to be used for the frame and the frame has not yet been set up for remote control, perform setup in accordance with Setting Up 9931-EMDE Network Remote Control (p. 2-15).

Note: If installing a card in a frame already equipped for, and connected to DashBoard™, no network setup is required for the card. The card will be discovered by DashBoard™ and be ready for use.

Installing a Rear Module

- Notes:**
- This procedure is applicable **only if a Rear Module is not currently installed** in the slot where the 9931-EMDE is to be installed.
 - Where options are furnished using a piggyback card mounted to 9931-EMDE main card, **base** Rear Module must be installed in frame location such that Rear Module interfaces with **base card**. **Expansion** Rear Module must be installed in frame location such that Rear Module interfaces with **expansion (piggyback) card** (see Figure 2-3).
 - Note that some Rear Modules and labels have several ventilation holes. To allow maximum ventilation, it is recommended to place the label fully over connectors such that label is flush with rear module and holes are not obscured. Also, when a card is not installed in a slot, it is recommended that the supplied blank cover be used to preserve proper forced ventilation flow-through.

The full assortment of 9931-EMDE Rear Modules is shown and described in 9931-EMDE Rear Modules (p. 2-7). Install a Rear Module as follows:

1. On the frame, determine the slot in which the 9931-EMDE is to be installed.
2. In the mounting area corresponding to the slot location, install Rear Module as shown in Figure 2-2.
3. If an expansion Rear Module is to be installed, install it adjacent to the base Rear Module as shown in Figure 2-3.

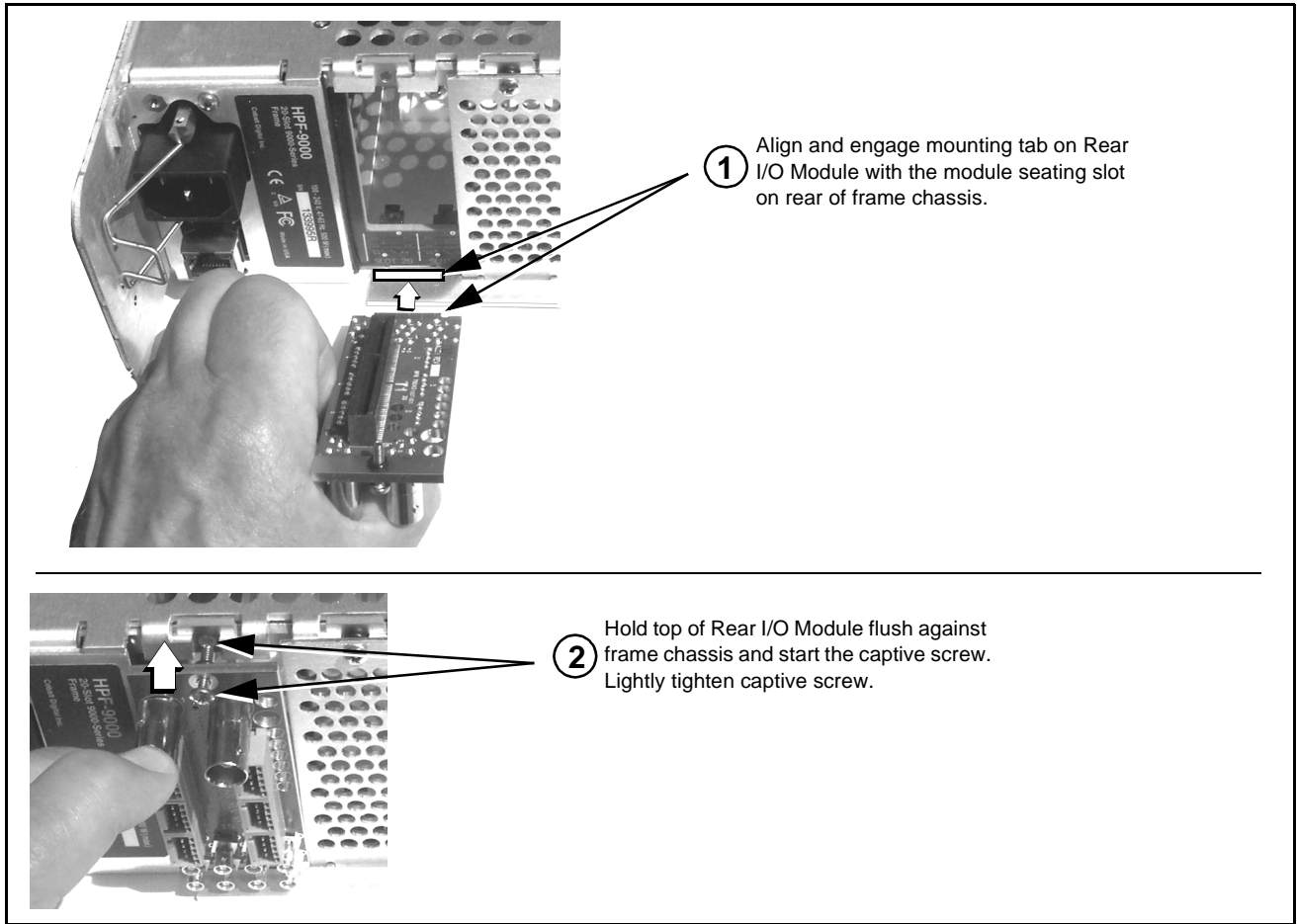
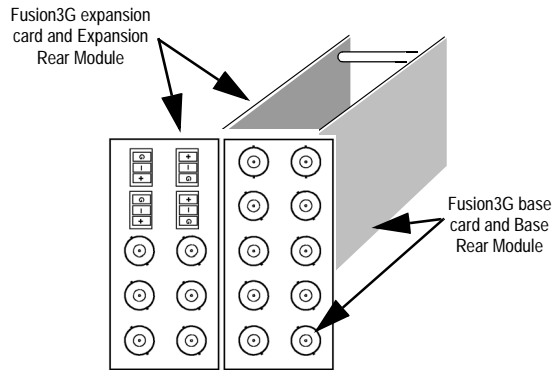
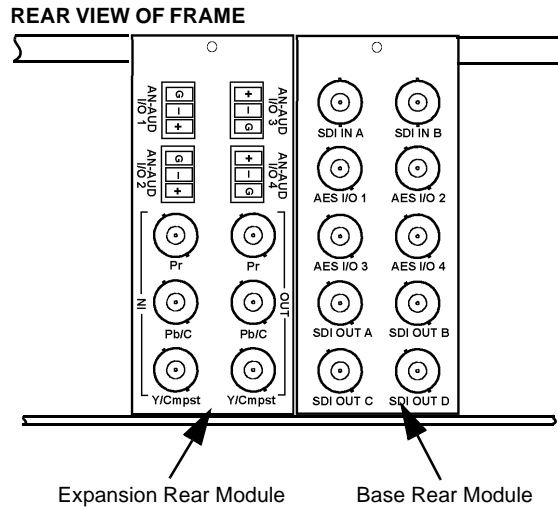

Figure 2-2 Rear Module Installation



Expansion Rear Module always mates to expansion piggyback card. Expansion Rear Module installs on slot directly to the **left** of base Rear Module.

Note: Where a base -HV rear module is to be used in conjunction with an expansion rear module, **a companion -HV expansion rear module must also be used**. Both base and expansion HV rear modules use card positioning that optimizes air flow across the component surface of the card PCB.

	<p>COBALT RM20-9001-B/S-DIN</p>	<p>Due to the density of connector placement on Rear Modules using high-density connectors (e.g., RM20-9001-B/S-DIN), these modules use a QR barcode label instead a regular label. Simply scan the image with a smart phone and a link to the rear module label (as shown in our catalog) will appear. (Smart phone must have a QR reader app such as QuickMark QR Code Reader or equivalent.)</p> <p>Not all devices may be able to acquire the image. If this occurs, use the device to access the web page for card/rear module to view the diagram.</p>
	<p>**SAMPLE-NOT FOR USE**</p>	

Figure 2-3 9931-EMDE with Expansion Rear Module

9931-EMDE Rear Modules

Table 2-1 shows and describes the full assortment of Rear Modules specifically for use with the 9931-EMDE.

- Notes:**
- Rear Modules equipped with multi-wire Phoenix connectors are supplied with removable screw terminal block adapters. For clarity, the adapters are omitted in the drawings below. Refer to Connecting To Phoenix Terminal Connectors (p. 2-15) for connector polarity orientation details.
 - The Rear Modules shown here are standard production items. Other signal combinations may be available as custom items. Consult Product Support with requests. Also, please check our web site pages for this product; new Rear Modules may be available that are not listed here.
 - AES and AN-AUD connectors function only as **outputs** on 9931-DE De-Embedder. AES and AN-AUD connectors function only as **inputs** on 9931-EM Embedder.
 - **Option**  Some connections types described here on Expansion Rear Modules are functional only on cards equipped with corresponding options. Base Rear I/O Modules provide connections for standard card BNC video and audio connections, with the rear module mating directly with the Fusion3G[®] card. Expansion Rear I/O Modules are required for some video and audio options, such as analog audio/video and fiber connections. These rear modules mate with an Expansion piggyback card that is mounted to the base Fusion3G[®] card when equipped with these options.

Table 2-1 9931-EMDE Rear Modules

9931-EMDE Rear Module	Description
<p>RM20-9931-B Base Rear Module</p> 	<p>Provides the following connections:</p> <ul style="list-style-type: none"> • 3G/HD/SD-SDI video input BNC (SDI IN A) • Four AES I/O BNC (AES-3id) input/outputs (AES I/O 1 thru AES I/O 4; I/O function of each connection is software-configurable) • Four 3G/HD/SD-SDI video output BNCs (SDI OUT A thru SDI OUT D)

Table 2-1 9931-EMDE Rear Modules — continued

9931-EMDE Rear Module	Description
<p>RM20-9931-D Base Rear Module</p> 	<p>Provides the following connections:</p> <ul style="list-style-type: none"> • 3G/HD/SD-SDI video input BNC (SDI IN A) • Four AES I/O BNC (AES-3id) input/outputs (AES I/O 1 thru AES I/O 4; I/O function of each connection is software-configurable) • Two opto-isolated GPI inputs (terminals GPI 1-G and GPI 2-G) • Two SPST NO GPO relay closure contacts (floating) (terminals GPO 1/1 and 2/2) • Two 3G/HD/SD-SDI video output BNCs (SDI OUT A and SDI OUT B)
<p>RM20-9931-E Base Rear Module</p> 	<p>Provides the following connections:</p> <ul style="list-style-type: none"> • 3G/HD/SD-SDI video input BNC (SDI IN A) • Eight AES I/O BNC (AES-3id) input/outputs (AES I/O 1 thru AES I/O 8; I/O function of each connection is software-configurable) • Two opto-isolated GPI inputs (terminals GPI 1-G and GPI 2-G) • Two SPST NO GPO relay closure contacts (floating) (terminals GPO 1/1 and 2/2) • Two RS485 serial ports; GUI configurable for function (COMM1 and COMM2) • Four 3G/HD/SD-SDI video output BNCs (SDI OUT A thru SDI OUT D)

Table 2-1 9931-EMDE Rear Modules — continued

9931-EMDE Rear Module	Description
<p>RM20-9931-F Base Rear Module</p>  <p>The diagram shows a vertical array of 10 BNC connectors. From top to bottom, the labels are: SDI IN A, AES 8, AES 1, AES 2, AES 3, AES 4, AES 5, AES 6, AES 7, and SDI OUT A.</p>	<p>Provides the following connections:</p> <ul style="list-style-type: none"> • 3G/HD/SD-SDI video input BNC (SDI IN A) • Eight AES I/O BNC (AES-3id) input/outputs (AES 1 thru AES 8; I/O function of each connection is software-configurable) • 3G/HD/SD-SDI video output BNC (SDI OUT A)
<p>RM20-9931-G Base Rear Module</p>  <p>The diagram shows a 5x4 grid of BNC connectors. The labels for each connector are: Row 1: AES I/O 7, AES I/O 8, SDI IN A, NC; Row 2: AES OUT 1, AES OUT 5, AES I/O 1, AES I/O 4; Row 3: AES OUT 2, AES OUT 6, AES I/O 2, AES I/O 5; Row 4: AES OUT 3, AES OUT 7, AES I/O 3, AES I/O 6; Row 5: AES OUT 4, AES OUT 8, SDI OUT A, SDI OUT B.</p>	<p>Provides the following connections:</p> <ul style="list-style-type: none"> • 3G/HD/SD-SDI video input BNC (SDI IN A) • Eight AES I/O BNC (AES-3id) input/outputs (AES I/O 1 thru AES I/O 8; I/O function of each connection is software-configurable) • Eight additional AES BNC (AES-3id) outputs (AES OUT 1 thru AES OUT 8) • Two 3G/HD/SD-SDI video output BNCs (SDI OUT A and SDI OUT B) <p>Note: Operational only in conjunction with card option +AESOUT16. Rear module mates with base Fusion3G® card and option expansion card.</p>

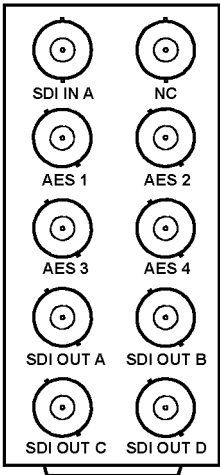
Table 2-1 9931-EMDE Rear Modules — continued

9931-EMDE Rear Module	Description
<p>RM20-9931-H Base Rear Module</p> 	<p>Provides the following connections:</p> <ul style="list-style-type: none"> • 3G/HD/SD-SDI video input BNC (SDI IN A) • Two opto-isolated GPI inputs (terminals GPI 1-G and GPI 2-G) • Two SPST NO GPO relay closure contacts (floating) (terminals GPO 1/1 and 2/2) • Two RS485 serial ports; GUI configurable for function (COMM1 and COMM2) • Four 3G/HD/SD-SDI video output BNCs (SDI OUT A thru SDI OUT D)
<p>RM20-9931-J Base Rear Module</p> 	<p>Provides the following connections:</p> <ul style="list-style-type: none"> • 3G/HD/SD-SDI video input BNCs (SDI IN A) • Two opto-isolated GPI inputs (terminals GPI 1-G and GPI 2-G) • Two SPST NO GPO relay closure contacts (floating) (terminals GPO 1/1 and 2/2) • Four 3G/HD/SD-SDI video output BNCs (SDI OUT A thru SDI OUT D)
<p>RM20-9931-XB Expansion Rear Module</p> 	<p>Used in conjunction with a base Rear Module to provide the following additional connections:</p> <ul style="list-style-type: none"> • Four analog balanced audio I/O (AN-AUD I/O 1 thru AN-AUD I/O 4; I/O function of each connection is switch-configurable) • Analog Y/composite, Pr/C, and Pb coaxial inputs (Y IN, Pr IN, and Pb/C IN, respectively) • Analog Y/composite, Pr/C, and Pb coaxial outputs (Y OUT, Pr OUT, and Pb/C OUT, respectively)

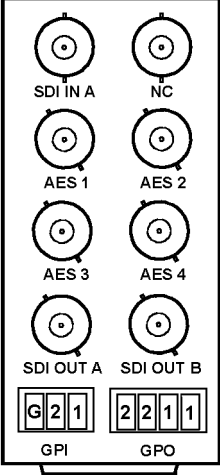
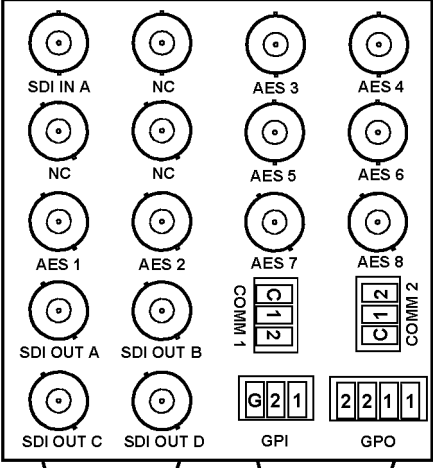
Table 2-1 9931-EMDE Rear Modules — continued

9931-EMDE Rear Module	Description												
<p>Note: When using Y/C (“S-video”) analog input or output, connections are as shown below and not as shown on label (which correspond to YPbPr and composite mode connections).</p> <table border="1" data-bbox="263 441 737 606"> <thead> <tr> <th>Label</th> <th>Y/C Input Mode</th> <th>Y/C Output Mode</th> </tr> </thead> <tbody> <tr> <td>Pr</td> <td>C</td> <td>C</td> </tr> <tr> <td>Pb/C</td> <td>Y</td> <td>Y</td> </tr> <tr> <td>Y/Cmpst</td> <td>NC</td> <td>Composite</td> </tr> </tbody> </table>	Label	Y/C Input Mode	Y/C Output Mode	Pr	C	C	Pb/C	Y	Y	Y/Cmpst	NC	Composite	
Label	Y/C Input Mode	Y/C Output Mode											
Pr	C	C											
Pb/C	Y	Y											
Y/Cmpst	NC	Composite											
<p>RM20-9931-XC Expansion Rear Module</p> 	<p>Used in conjunction with a base Rear Module to provide the following additional connections:</p> <ul style="list-style-type: none"> • Eight analog balanced audio I/O (AN-AUD I/O 1 thru AN-AUD I/O 8; I/O function of each connection is switch-configurable) • Two fiber I/O (GUI configurable as I/O) 												
<p>RM20-9931-XD Expansion Rear Module</p> 	<p>Used in conjunction with a base Rear Module to provide the following additional connections:</p> <ul style="list-style-type: none"> • Six analog balanced audio I/O (AN-AUD I/O 1 thru AN-AUD I/O 6; I/O function of each connection is switch-configurable) • Analog Y/composite, Pr/C, and Pb coaxial inputs (Y IN, Pr IN, and Pb/C IN, respectively) • Analog composite output (Cmpst OUT) 												

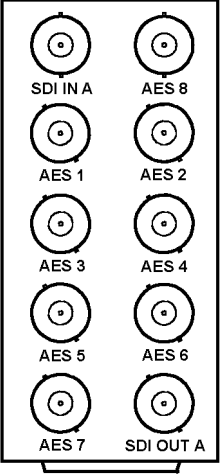
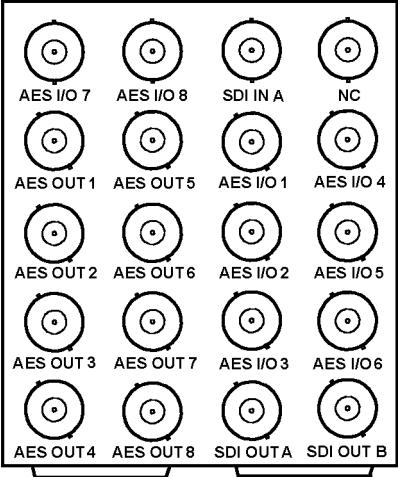
Table 2-1 9931-EMDE Rear Modules — continued

9931-EMDE Rear Module	Description
<p>RM20-9931-XE Expansion Rear Module</p>  <p>The diagram shows the rear panel of the RM20-9931-XE module. On the left, there are eight balanced audio I/O ports labeled I/O 1 through I/O 8, grouped under 'AN-AUD'. To the right of these are two fiber I/O ports labeled 1 and 2. Below the audio ports are four SDI output ports labeled SDI OUT E, SDI OUT F, SDI OUT G, and SDI OUT H. At the bottom, there are four coaxial ports: two labeled 'Pr' (Pr/C IN and Pr/C OUT), two labeled 'Pb/C' (Pb/C IN and Pb/C OUT), and two labeled 'Y/Cmpst' (Y/Cmpst IN and Y/Cmpst OUT).</p>	<p>Used in conjunction with a base Rear Module to provide the following additional connections:</p> <ul style="list-style-type: none"> • Eight analog balanced audio I/O (AN-AUD I/O 1 thru AN-AUD I/O 8; I/O function of each connection is switch-configurable) • Two fiber I/O (GUI configurable as I/O) • Four expansion 3G/HD/SD-SDI coaxial outputs (reserved function) • Analog Y/composite, Pr/C, and Pb coaxial inputs (Y IN, Pr IN, and Pb/C IN, respectively) • Analog Y/composite, Pr/C, and Pb coaxial outputs (Y OUT, Pr OUT, and Pb/C OUT, respectively)
<p>RM20-9931-XF Expansion Rear Module</p>  <p>The diagram shows the rear panel of the RM20-9931-XF module. On the left, there are two balanced audio I/O ports labeled I/O 1 and I/O 2, grouped under 'AN-AUD'. To the right are two fiber I/O ports labeled 1 and 2. Below these are four coaxial ports: two labeled 'Pr' (Pr/C IN and Pr/C OUT), two labeled 'Pb/C' (Pb/C IN and Pb/C OUT), and two labeled 'Y/Cmpst' (Y/Cmpst IN and Y/Cmpst OUT).</p>	<p>Used in conjunction with a base Rear Module to provide the following additional connections:</p> <ul style="list-style-type: none"> • Two analog balanced audio I/O (AN-AUD I/O 1 and AN-AUD I/O 2; I/O function of each connection is switch-configurable) • Two fiber I/O (GUI configurable as I/O) • Analog Y/composite, Pr/C, and Pb coaxial inputs (Y IN, Pr IN, and Pb/C IN, respectively) • Analog Y/composite, Pr/C, and Pb coaxial outputs (Y OUT, Pr OUT, and Pb/C OUT, respectively)

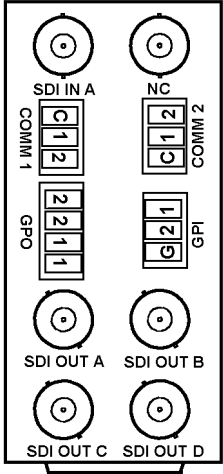
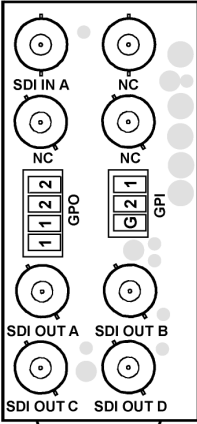
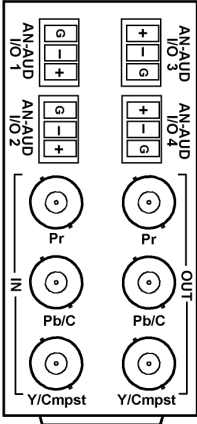
Table 2-1 9931-EMDE Rear Modules — continued

9931-EMDE Rear Module	Description
<p>High-Ventilation Rear Modules</p>	
<p>High Ventilation (HV) Rear Modules offer coaxial connections using miniaturized connectors (HDBNC or DIN 1.0/2.3), thereby freeing-up area for openings to increase ventilation. This is helpful where normal above-frame ventilation space cannot be accommodated, or in cases where the frame is fitted with a large amount of high-power cards (such as the 9931-EMDE, and especially when equipped with options requiring a piggyback card such as option +ANAIO).</p>	
<p>Where a base HV rear module is to be used in conjunction with an expansion rear module, a companion expansion rear module of the -HV type must also be used. (For example, base module RM20-9931-B-HV can be used with expansion module RM20-9931-XB-HV. RM20-9931-B-HV cannot be used with “normal” expansion module RM20-9931-XB.) See Figure 2-3 for other considerations regarding HV rear modules.</p>	
<p>RM20-9931-B-HV Base High-Ventilation Rear Module</p>  <p>The diagram shows the connector layout for the RM20-9931-B-HV module. On the left side, there are four AES I/O ports labeled AES 1/O 1, AES 1/O 2, AES 1/O 3, and AES 1/O 4. Above these is an SDI IN A port and an NC (No Connection) port. On the right side, there are four SDI OUT ports labeled A, B, C, and D.</p>	<p>Provides the following connections:</p> <ul style="list-style-type: none"> • 3G/HD/SD-SDI video inputs (SDI IN A) • Four AES I/O BNC (AES-3id) input/outputs (AES I/O 1 thru AES I/O 4; I/O function of each connection is software-configurable) • Four 3G/HD/SD-SDI video outputs (SDI OUT A thru SDI OUT D) <p>Note:</p> <ul style="list-style-type: none"> • AES inputs and outputs operational only with card option +AES installed. • Available equipped with High-Density BNC (HDBNC) or DIN1.0/2.3 connectors as: RM20-9931-B-HV-HDBNC or RM20-9931-B-HV-DIN, respectively.
<p>RM20-9931-F-HV Base High-Ventilation Rear Module</p>  <p>The diagram shows the connector layout for the RM20-9931-F-HV module. On the left side, there are eight AES I/O ports labeled AES 1/O 1 through AES 1/O 8. On the right side, there is an SDI IN A port, an NC (No Connection) port, and four SDI OUT ports labeled A, B, C, and D.</p>	<p>Provides the following connections:</p> <ul style="list-style-type: none"> • 3G/HD/SD-SDI video input (SDI IN A) • Eight AES I/O BNC (AES-3id) input/outputs (AES I/O 1 thru AES I/O 8; I/O function of each connection is software-configurable) • Four 3G/HD/SD-SDI video outputs (SDI OUT A thru SDI OUT D) <p>Note:</p> <ul style="list-style-type: none"> • AES inputs and outputs operational only with card option +AES installed. • Available equipped with High-Density BNC (HDBNC) or DIN1.0/2.3 connectors as: RM20-9931-F-HV-HDBNC or RM20-9931-F-HV-DIN, respectively.

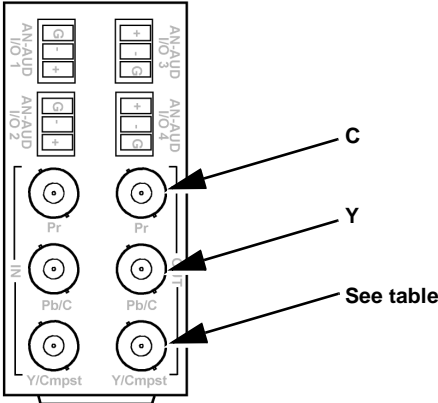
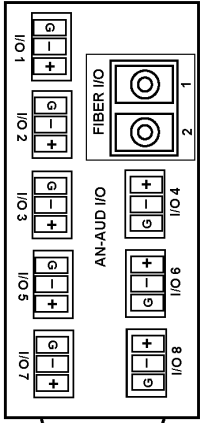
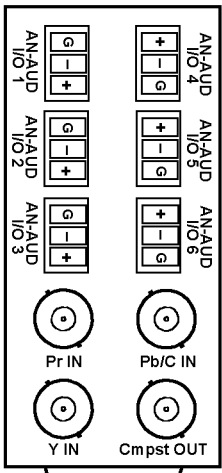
Table 2-1 9931-EMDE Rear Modules — continued

9931-EMDE Rear Module	Description
<p>RM20-9931-F-HV2 Base High-Ventilation Rear Module</p> 	<p>Provides the following connections:</p> <ul style="list-style-type: none"> • One 3G/HD/SD-SDI video inputs (SDI IN A) • Four AES I/O BNC (AES-3id) input/outputs (AES I/O 1 thru AES I/O 4; I/O function of each connection is software-configurable) • Four 3G/HD/SD-SDI video outputs (SDI OUT A thru SDI OUT D) <p>Note:</p> <ul style="list-style-type: none"> • AES inputs and outputs operational only with card option +AES installed. • This rear module provides optimized ventilation and should be used with hi-ventilation rear module RM20-9931-XF-HV where an expansion rear module is required for analog I/O and/or fiber I/O. • Available equipped with High-Density BNC (HDBNC) or DIN1.0/2.3 connectors as: RM20-9931-F-HV2-HDBNC or RM20-9931-F-HV2-DIN, respectively.
<p>RM20-9931-XB-HV Expansion High-Ventilation Rear Module</p> 	<p>Used in conjunction with high-ventilation base Rear Module RM20-9931-B-HV to provide the following additional connections:</p> <ul style="list-style-type: none"> • Four analog balanced audio I/O (AN-AUD I/O 1 thru AN-AUD I/O 4; I/O function of each connection is switch-configurable) • Analog Y/composite, Pr/C, and Pb coaxial inputs (Y IN, Pr IN, and Pb/C IN, respectively) • Analog Y/composite, Pr/C, and Pb coaxial outputs (Y OUT, Pr OUT, and Pb/C OUT, respectively) <p>Note:</p> <ul style="list-style-type: none"> • Analog inputs and outputs operational only with appropriate card option +ANA and +ANV installed. • Available equipped with High-Density BNC (HDBNC) or DIN1.0/2.3 connectors as: RM20-9931-XB-HV-HDBNC or RM20-9931-XB-HV-DIN, respectively.

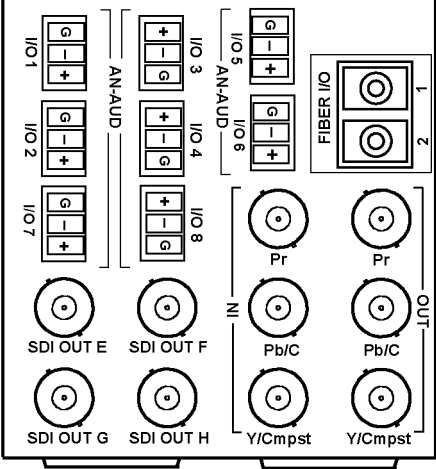
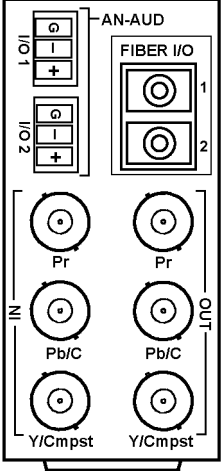
Table 2-1 9931-EMDE Rear Modules — continued

9931-EMDE Rear Module	Description
<p>RM20-9931-XF-HV Expansion High-Ventilation Rear Module</p> 	<p>Used in conjunction with high-ventilation base Rear Module RM20-9931-F-HV to provide the following additional connections:</p> <ul style="list-style-type: none"> • Two analog balanced audio I/O (AN-AUD I/O 1 and AN-AUD I/O 2; I/O function of each connection is switch-configurable) • Analog Y/composite, Pr/C, and Pb coaxial inputs (Y/CVBS IN, Pr IN, and Pb/C IN, respectively) • Analog Y/composite, Pr/C, and Pb coaxial outputs (Y/CVBS OUT, Pr OUT, and Pb/C OUT, respectively) • Two fiber I/O (GUI configurable as I/O) <p>Note:</p> <ul style="list-style-type: none"> • Analog inputs and outputs operational only with appropriate card option +ANA and +ANV installed. • Available equipped with High-Density BNC (HDBNC) or DIN1.0/2.3 connectors as: RM20-9931-XF-HV-HDBNC or RM20-9931-XF-HV-DIN, respectively.

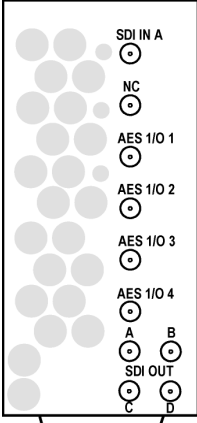
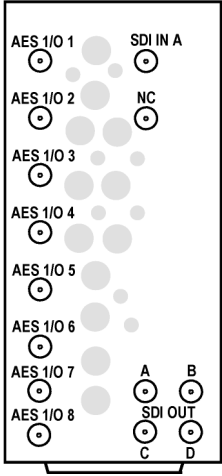
Connecting To Phoenix Terminal Connectors

Figure 2-4 shows connections to the card Phoenix™ terminal block connectors. These connectors are used for card analog audio, serial comm, and GPIO connections. These terminal blocks use a removable screw terminal binding post block which allows easier access to the screw terminals.

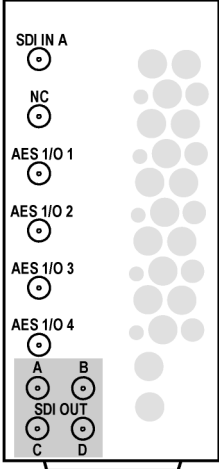
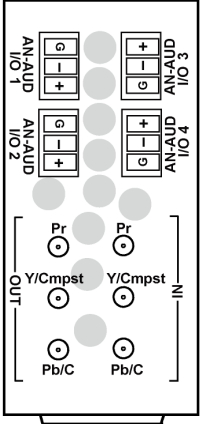
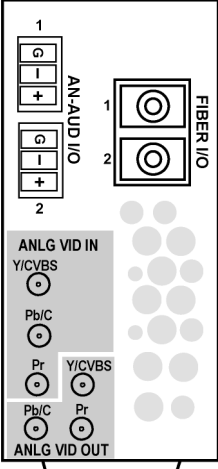
Note: It is preferable to wire connections to Phoenix plugs oriented as shown in Figure 2-4 rather than assessing polarity on rear module connectors. Note that the orientation of rear module connectors is not necessarily consistent within a rear module, or between different rear modules. If wiring is first connected to Phoenix plug oriented as shown here, the electrical orientation will be correct regardless of rear module connector orientation.

Setting Up 9931-EMDE Network Remote Control

Perform remote control setup in accordance with Cobalt® reference guide “Remote Control User Guide” (PN 9000RCS-RM).

Note:

- If network remote control is to be used for the frame and the frame has not yet been set up for remote control, Cobalt® reference guide **Remote Control User Guide (PN 9000RCS-RM)** provides step-by-step instructions for setting up network remote control of COMPASS™ cards using DashBoard™. (Cobalt® OGCP-9000 and OGCP-9000/CC Remote Control Panel product manuals have complete instructions for setting up remote control using a Remote Control Panel.)
- If installing a card in a frame already equipped for, and connected to DashBoard™, no network setup is required for the card. The card will be discovered by DashBoard™ and be ready for use.

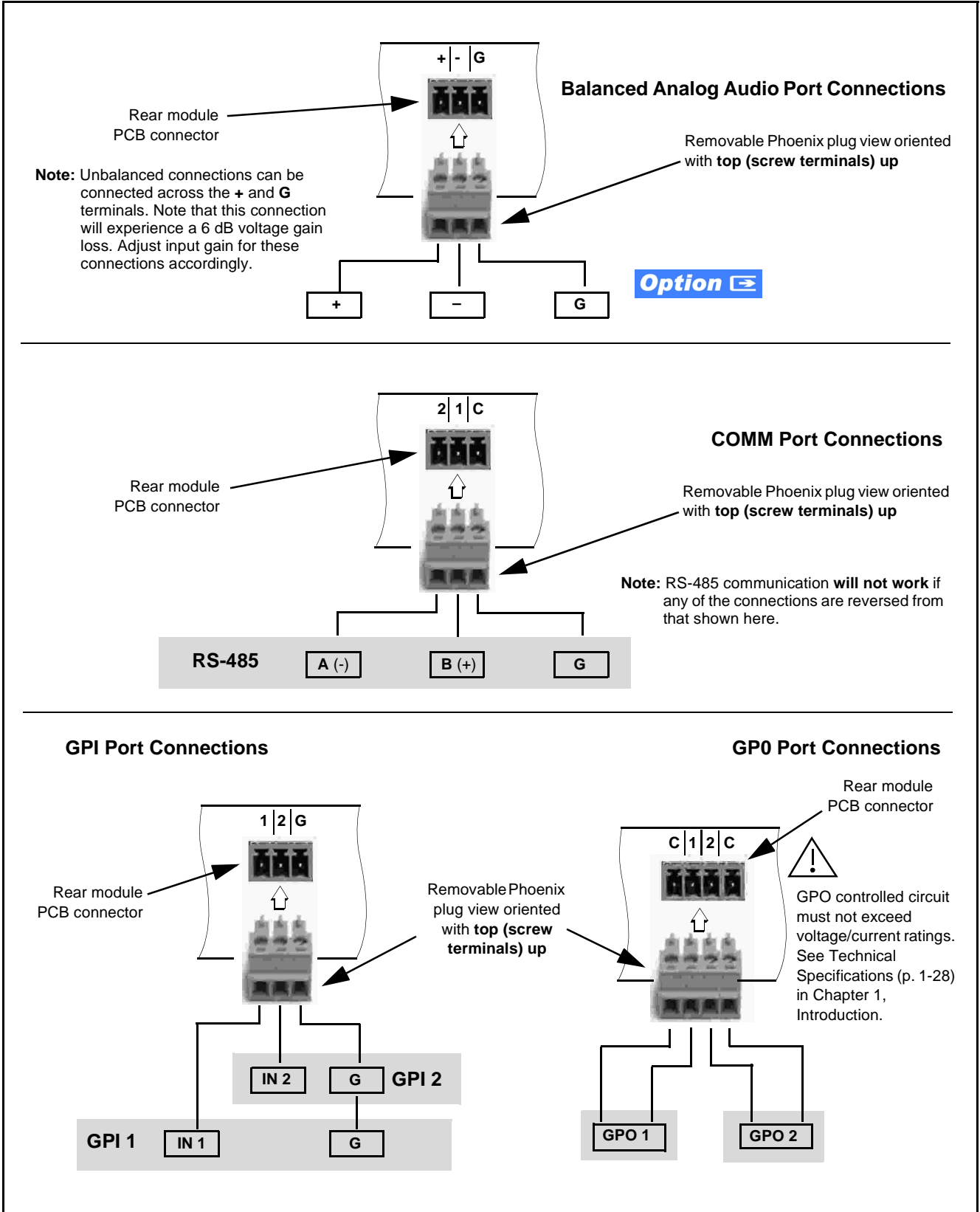

Figure 2-4 Phoenix Terminal Connections

Operating Instructions

Overview

If you are already familiar with using DashBoard or a Cobalt Remote Control Panel to control Cobalt cards, please skip to 9931-EMDE Function Menu List and Descriptions (p. 3-10).

This chapter contains the following information:

- Control and Display Descriptions (p. 3-1)
- Accessing the 9931-EMDE Card via Remote Control (p. 3-6)
- Checking Card Information (p. 3-8)
- Ancillary Data Line Number Locations and Ranges (p. 3-9)
- 9931-EMDE Function Menu List and Descriptions (p. 3-10)
- Troubleshooting (p. 3-63)

Control and Display Descriptions

Note: When you are familiar with the card functions and controls described in this chapter, please go to the Support>Documents>Reference Guides link at www.cobaltdigital.com for Fusion3G[®] application notes covering comprehensive setup of practical processing applications.

This section describes the user interface controls, indicators, and displays (both on-card and remote controls) for using the 9931-EMDE card. The 9931-EMDE functions can be accessed and controlled using any of the user interfaces described here.

The format in which the 9931-EMDE functional controls, indicators, and displays appear and are used varies depending on the user interface being used. Regardless of the user interface being used, access to the 9931-EMDE functions (and the controls, indicators, and displays related to a particular function) follows a general arrangement of Function Menus under which related controls can be accessed (as described in Function Menu/Parameter Menu Overview below).

After familiarizing yourself with the arrangement described in Function Menu/Parameter Menu Overview, proceed to the subsection for the particular user interface being used. Descriptions and general instructions for using each user interface are individually described in the following subsections:

- DashBoard™ User Interface (p. 3-4)
- Cobalt® Remote Control Panel User Interfaces (p. 3-5)

Note: When a setting is changed, settings displayed on DashBoard™ (or a Remote Control Panel) are the settings as effected by the 9931-EMDE card itself and reported back to the remote control; the value displayed at any time is the actual value as set on the card.

Function Menu/Parameter Menu Overview

The functions and related parameters available on the 9931-EMDE card are organized into function **menus**, which consist of parameter groups as shown below.

Figure 3-1 shows how the 9931-EMDE card and its menus are organized, and also provides an overview of how navigation is performed between cards, function menus, and parameters.

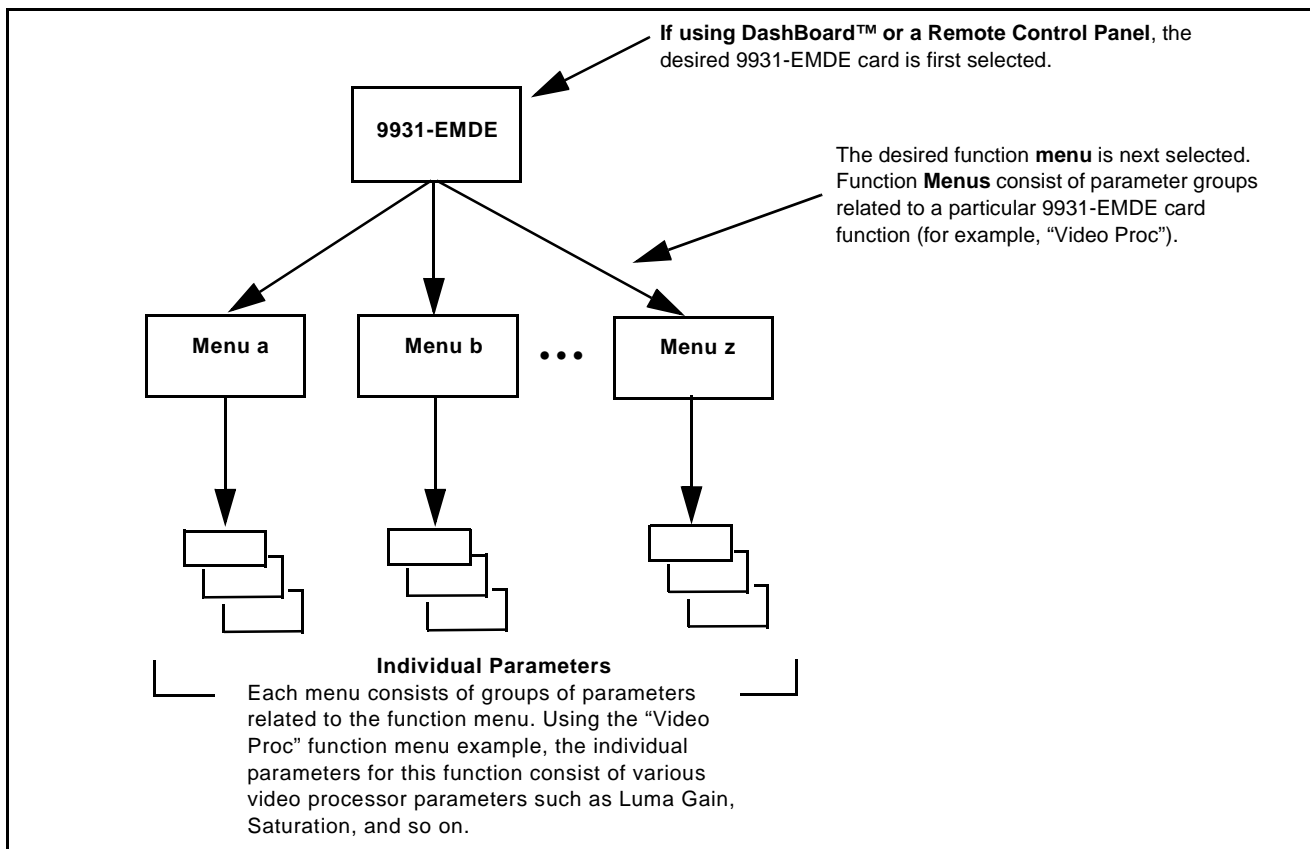

Figure 3-1 Function Menu/Parameter Menu Overview

9931-EMDE Card Edge Controls, Indicators, and Display

Figure 3-2 shows and describes the 9931-EMDE card edge controls, indicators, and display.

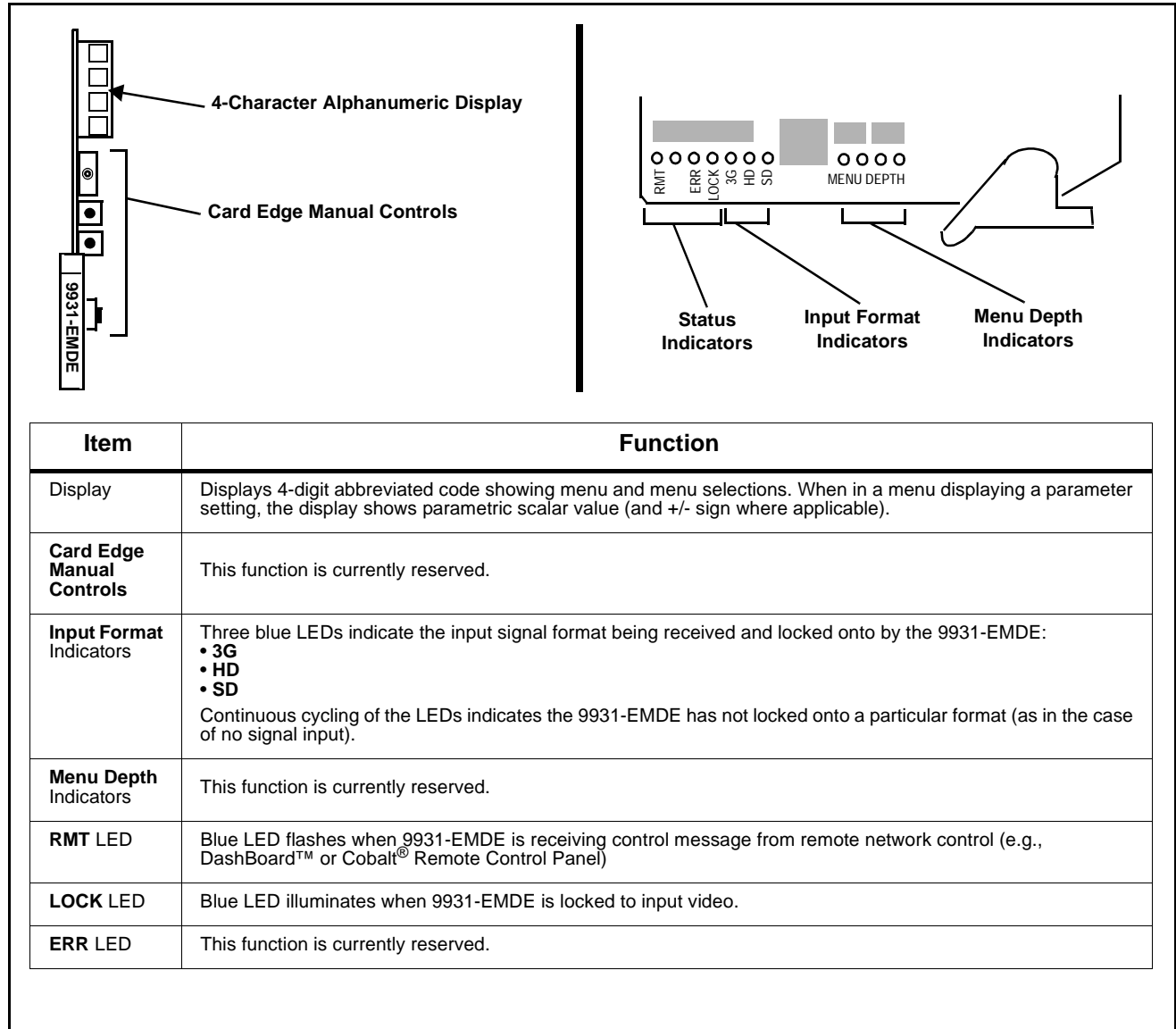

Figure 3-2 9931-EMDE Card Edge Controls, Indicators, and Display

DashBoard™ User Interface

(See Figure 3-3.) The 9931-EMDE function menus are organized in DashBoard™ using tabs (for example, “Video Proc” in Figure 3-3). When a tab is selected, each parametric control or selection list item associated with the function is displayed. Scalar (numeric) parametric values can then be adjusted as desired using the GUI slider controls. Items in a list can then be selected using GUI drop-down lists.

The screenshot shows the DashBoard™ interface for the Video Proc function. At the top, there are several tabs: Video Proc, Framesync, Scaler, Input Audio Status, Audio Bus Input Routing/Controls, and Output Audio Routing/Controls. The Video Proc tab is selected. Below the tabs, there is a 'Video Proc' section with an 'On' button and a 'Reset to Unity' button with a 'Confirm' button. Underneath is the 'Basic Video Proc' section, which includes sliders for Luma Gain (set to 120.0), Luma Lift (set to 0.0), Color Gain (set to 90.0), and Color Phase (set to 0.0). There is also a 'Gang Luma/Color Gain' button set to 'Off'. The 'Detail Enhancement' section includes sliders for Sharpness Level (set to 0), Sharpness Threshold (set to 0), and Noise Reduction (set to 0). Annotations with arrows point to the 'Video Proc' tab, the 'On' button, the Luma Gain slider, and the Color Gain slider. A separate diagram shows a 'Main Tab' with sub-tabs 'Video Proc' and 'Color Correction'.

Select top-level menu item Video Proc

Set Video Proc enable to On

Set Luma Gain to 120 using direct numeric entry or slider control

Set Color Gain to 90

Main Tab

Sub Tabs

Some 9931-EMDE tabs have sub-tabs at the bottom of the pane which allow access to additional functions without the clutter of all controls appearing in a single pane. In this example, Color Correction controls in addition to the Video Proc controls shown here can be accessed by clicking the **Color Correction** sub-tab.

Figure 3-3 DashBoard™ Setup of Example Video Proc Function

Cobalt® Remote Control Panel User Interfaces

(See Figure 3-4.) Similar to the function menu tabs using DashBoard™, the Remote Control Panels have a Select Submenu key that is used to display a list of function menus. From this list, a control knob on the Control Panel is used to select a function from the list of displayed function menu items.

When the desired function menu is selected, each parametric control or selection list item associated with the function is displayed. Scalar (numeric) parametric values can then be adjusted as desired using the control knobs, which act like a potentiometer. Items in a list can then be selected using the control knobs which correspondingly act like a rotary selector.

Figure 3-4 shows accessing a function menu and its parameters (in this example, “Video Proc”) using the Control Panel.

Note: Refer to “OGCP-9000 Remote Control Panel User Manual” (PN OGCP-9000-OM) or “OGCP-9000/CC Remote Control Panel User Manual” (PN OGCP-9000/CC-OM) for complete instructions on using the Control Panels.

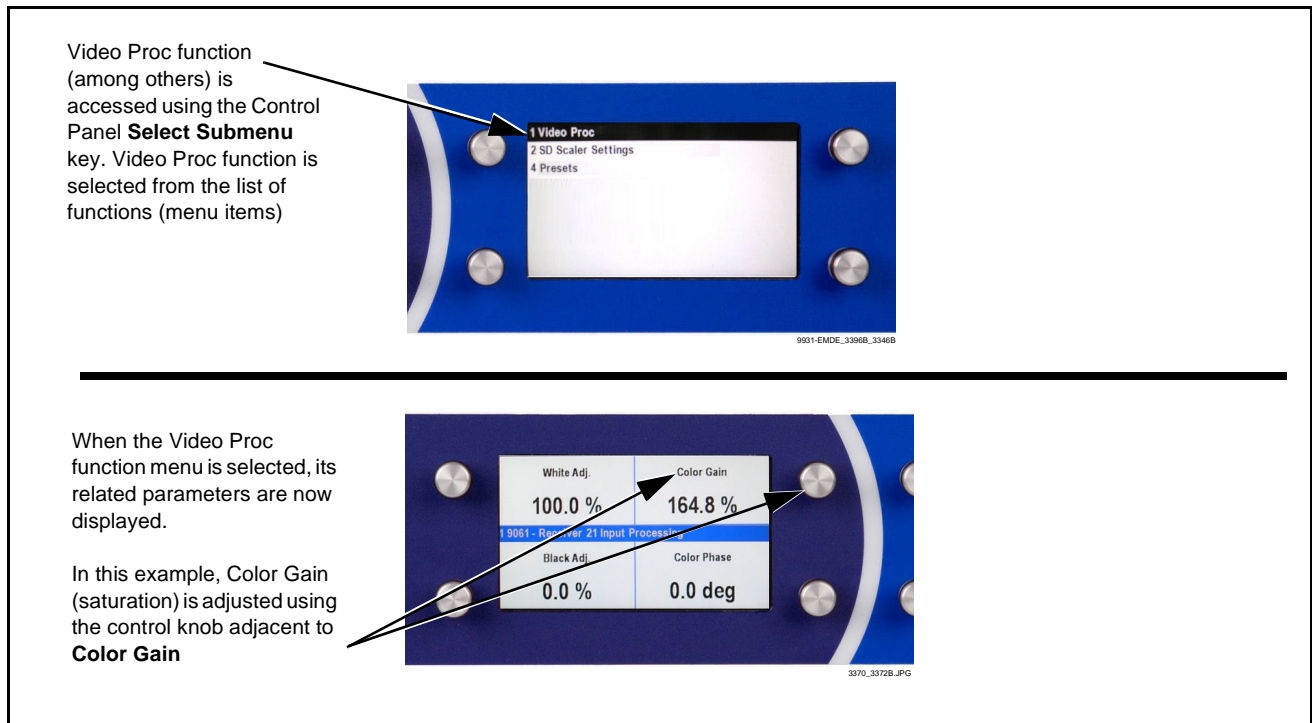

Figure 3-4 Remote Control Panel Setup of Example Video Proc Function Setup

Accessing the 9931-EMDE Card via Remote Control

Access the 9931-EMDE card using DashBoard™ or Cobalt® Remote Control Panel as described below.

Accessing the 9931-EMDE Card Using DashBoard™

1. On the computer connected to the frame LAN, open DashBoard™.
2. As shown below (in the left side Basic View Tree) locate the Network Controller Card associated with the frame containing the 9931-EMDE card to be accessed (in this example, “MFC-8320-N SN: 00108053”).

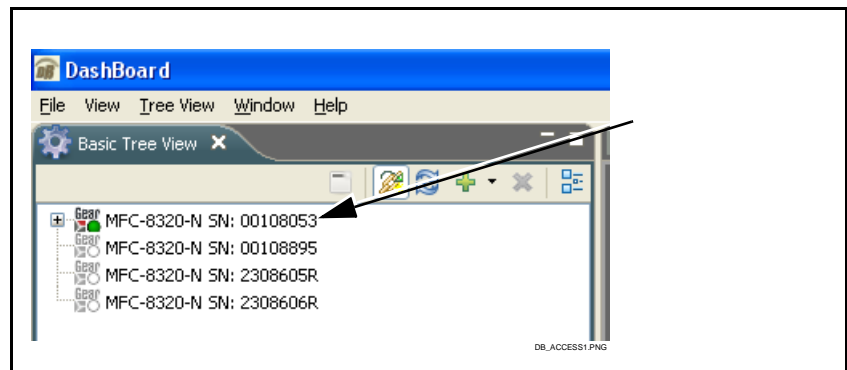

3. As shown below, expand the tree to access the cards within the frame. Click on the card to be accessed (in this example, “slot 6: 9931-EMDE”).

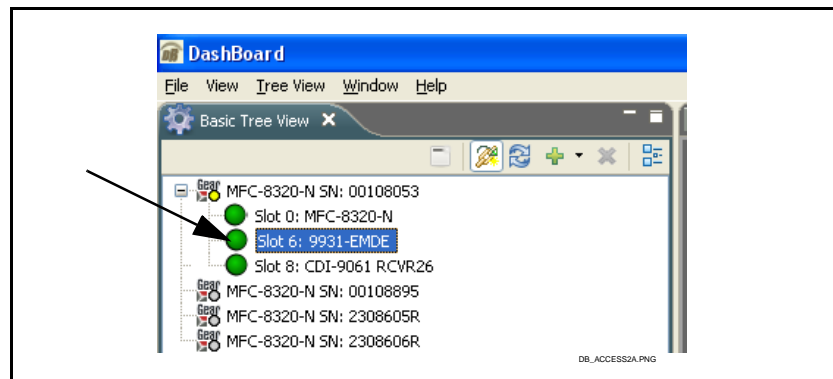

As shown on the next page, when the card is accessed in DashBoard™ its function menu screen showing tabs for each function is displayed. (The particular menu screen displayed is the previously displayed screen from the last time the card was accessed by DashBoard™).

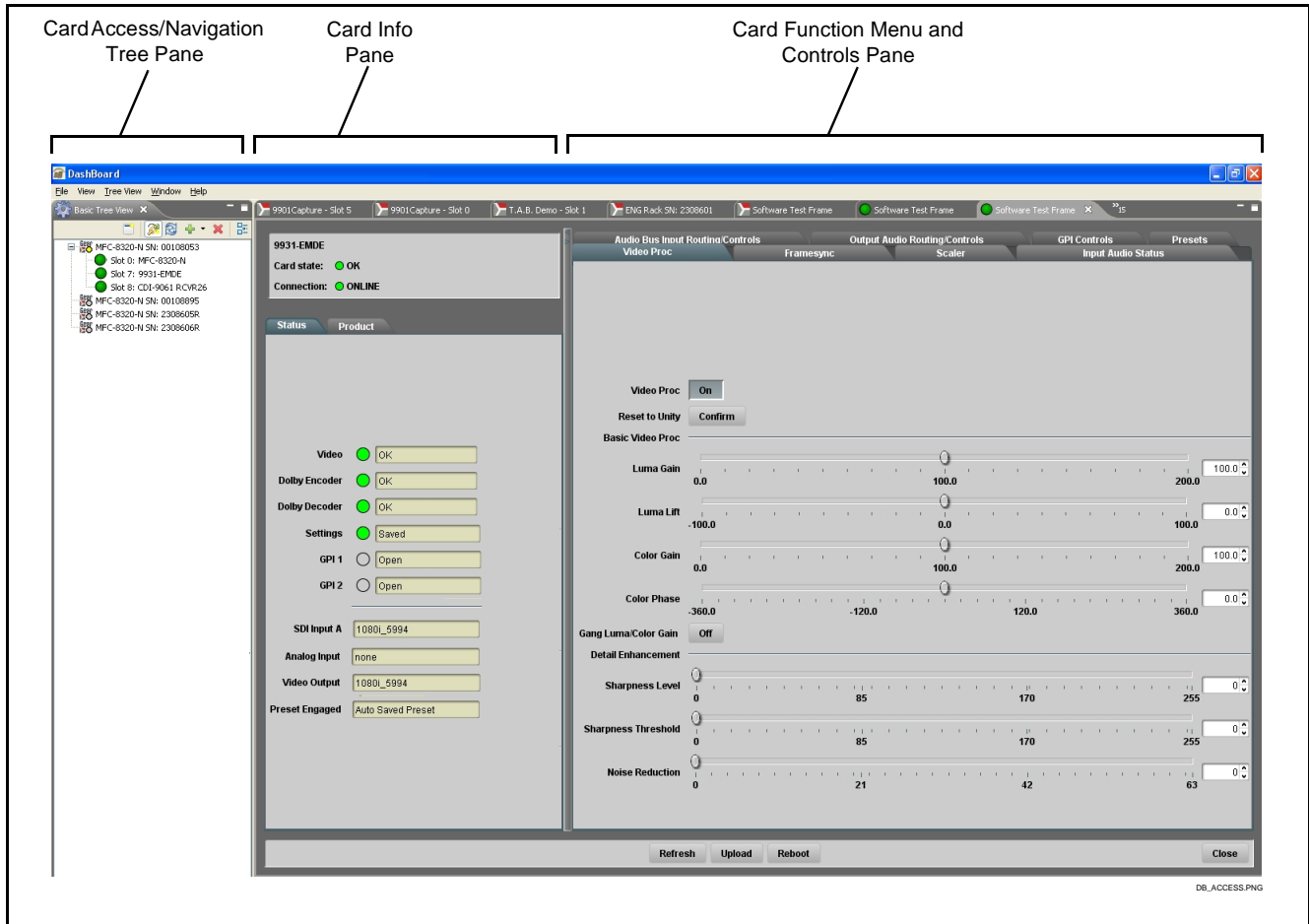

Accessing the 9931-EMDE Card Using a Cobalt® Remote Control Panel

Press the **Select Device** key and select a card as shown in the example below.

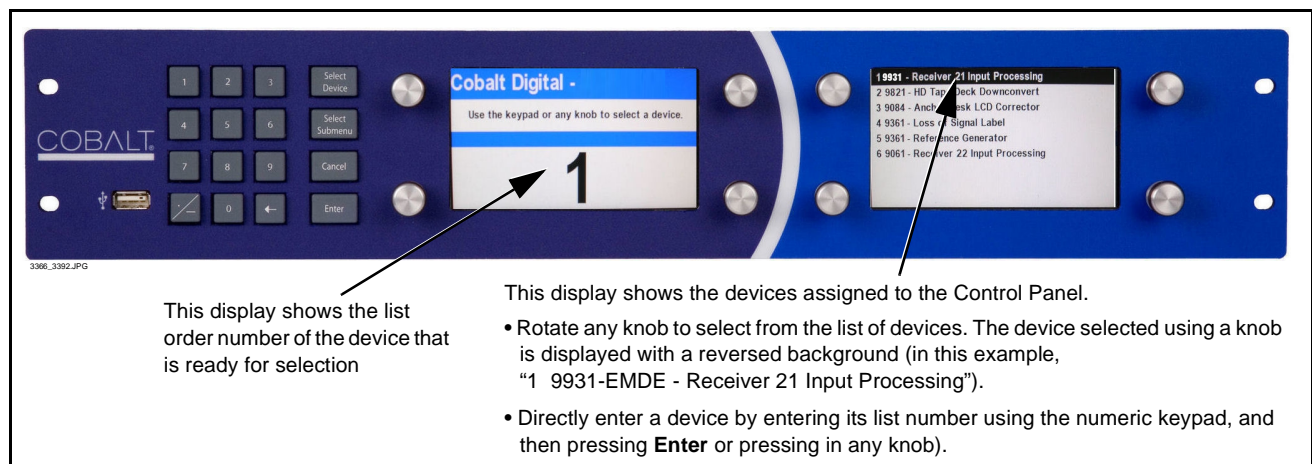

Checking Card Information

The operating status and software version the 9931-EMDE card can be checked using DashBoard™. Figure 3-5 shows and describes the 9931-EMDE card information screen using DashBoard™.

Note: Proper operating status in DashBoard™ is denoted by green icons for the status indicators shown in Figure 3-5. Yellow or red icons respectively indicate an alert or failure condition. Refer to Troubleshooting (p. 3-63) for corrective action.

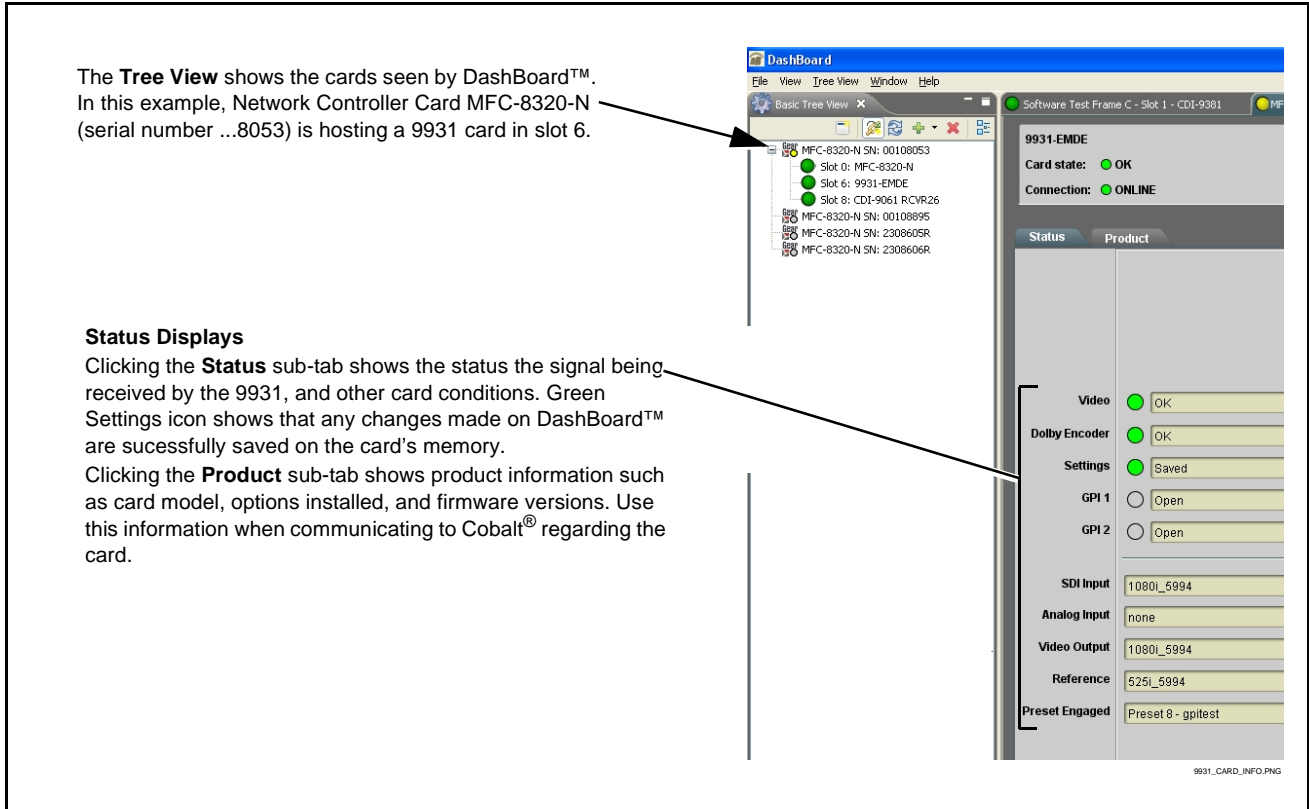

Figure 3-5 9931-EMDE Card Info Utility

Ancillary Data Line Number Locations and Ranges

Table 3-1 lists typical default output video VANC line number locations for various ancillary data items that may be passed or handled by the card.

Table 3-1 Typical Ancillary Data Line Number Locations/Ranges

Item	Default Line No. / Range	
	SD	HD
AFD	12 (Note 2)	9 (Note 2)
ATC_VITC	13 (Note 2)	9/8 (Note 2)
ATC_LTC	—	10 (Note 2)
Dolby® Metadata	13 (Note 2)	13 (Note 2)
SDI VITC Waveform	14/16 (Note 2)	—
Closed Captioning	21 (locked)	10 (Note 2)

Notes:

- The card does not check for conflicts on a given line number. Make certain the selected line is available and carrying no other data.
- While range indicated by drop-down list on GUI may allow a particular range of choices, the actual range is automatically clamped (limited) to certain ranges to prevent inadvertent conflict with active picture area depending on video format. Limiting ranges for various output formats are as follows:

Format	Line No. Limiting	Format	Line No. Limiting	Format	Line No. Limiting
525i	12-19	720p	9-25	1080p	9-41
625i	9-22	1080i	9-20		

Because line number allocation is not standardized for all ancillary items, consideration should be given to all items when performing set-ups. Figure 3-6 shows an example of improper and corrected VANC allocation within an HD-SDI stream.

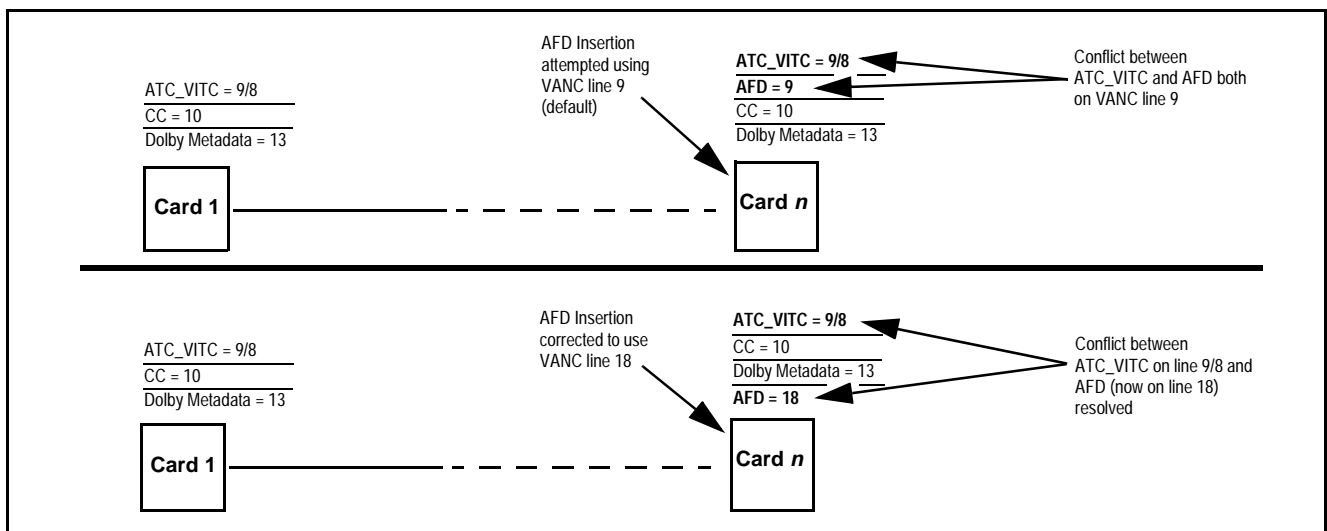



Figure 3-6 Example VANC Line Number Allocation Example

9931-EMDE Function Menu List and Descriptions

Table 3-2 individually lists and describes each 9931-EMDE function menu (“tab”) and its related list selections, controls, and parameters. Where helpful, examples showing usage of a function are also provided. Table 3-2 is primarily based upon using DashBoard™ to access each function and its corresponding menus and parameters.

- Note:**
- All numeric (scalar) parameters displayed on DashBoard™ can be changed using the slider controls,  arrows, or by numeric keypad entry in the corresponding numeric field. (When using numeric keypad entry, add a return after the entry to commit the entry.)
 - Some options are not described here. Refer to the option Manual Supplement(s) to this manual that have been shipped with your card. Please consult Product Support for more information.

On DashBoard™ itself and in Table 3-2, the function menu items are organized using tabs as shown below.

Dolby Encoder

Encoder Input
Internal Metadata

Some functions use **sub-tabs** to help maintain clarity and organization. In these instances, Table 3-2 shows the ordinate tab along with its sub-tabs. Highlighted sub-tabs indicate that controls described are found by selecting this sub-tab (in this example, the **Encoder Input** sub-tab).

Option 

Functions and/or features that are available only as an option are denoted in this section using this icon. When an option is not installed, tabs and controls for the function do not appear in the card DashBoard GUI.

Status
Product

Product 9901-UDX

Product Options +AES, +ANAIO, +ANAVI, +ANAVO, +WINGS

Card options installed on a particular card are shown in the **Product Options** display on the **Card Info** page. Not all options are covered in this manual. In these cases, Manual Supplement(s) for the option(s) ordered have been included in the binder containing this manual.

The table below provides a quick-reference to the page numbers where each function menu item can be found.

Function Menu Item	Page	Function Menu Item	Page
Video Proc/Color Correction	3-11	Audio Bus Input Routing/Controls	3-32
Timecode	3-15	Output Audio Routing/Controls	3-42
Closed Captioning	3-19	Upmixing	3-47
Framesync	3-21	COM and Metadata Routing	3-50
AFD/WSS/VI ARC Controls	3-24	GPIO Controls	3-52
Video Output Crosspoint Control	3-30	Presets	3-54
Input Audio Status	3-31	Event Based Preset Loading	3-55

Table 3-2 9931-EMDE Function Menu List







	<p>Provides the following Video Proc and Color Correction parametric controls.</p>
<p>• Video Proc</p> 	<p>Video Proc (On/Off) provides master on/off control of all Video Proc functions.</p> <ul style="list-style-type: none"> • When set to Off, Video Proc is bypassed. • When set to On, currently displayed parameter settings take effect.
<p>• Reset to Unity</p> 	<p>Reset to Unity provides unity reset control of all Video Proc functions. When Confirm is clicked, a Confirm? pop-up appears, requesting confirmation.</p> <ul style="list-style-type: none"> • Click Yes to proceed with the unity reset. • Click No to reject unity reset.
<p>• Luma Gain</p> 	<p>Adjusts gain percentage applied to Luma (Y channel). (0% to 200% range in 0.1% steps; unity = 100%)</p>
<p>• Luma Lift</p> 	<p>Adjusts lift applied to Luma (Y-channel). (-100% to 100% range in 0.1% steps; null = 0.0%)</p>
<p>• Color Gain</p> 	<p>Adjusts gain percentage (saturation) applied to Chroma (C-channel). (0% to 200% range in 0.1% steps; unity = 100%)</p>
<p>• Color Phase</p> 	<p>Adjusts phase angle applied to Chroma. (-360° to 360° range in 0.1° steps; null = 0°)</p>
<p>• Gang Luma/Color Gain</p> 	<p>When set to On, changing either the Luma Gain or Color Gain controls increases or decreases both the Luma and Color gain levels by equal amounts.</p>

Table 3-2 9931-EMDE Function Menu List — continued

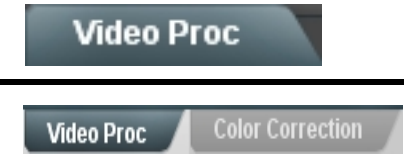

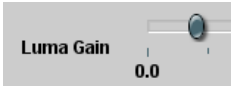

 <p>The image shows a navigation menu with 'Video Proc' highlighted in a dark blue box. Below it, two sub-menus are visible: 'Video Proc' and 'Color Correction', both in lighter blue boxes.</p>	<p>(continued)</p>
<p>• Detail Enhancement Controls</p>	<p>Sharpness Level, Threshold, and Noise Reduction controls (individually described below) which can be used to tailor output video sharpness per program material and aesthetic preferences.</p>
<p>• Sharpness Level Control</p>  <p>The image shows a slider control labeled 'Level' with a scale from 0 to 255. The slider knob is positioned approximately at the 125 mark.</p>	<p>Adjusts the aggressiveness of sharpening applied to MPEG video. Optimum setting results in overall perception of increased sharpness, while avoiding pattern noise artifacts.</p> <p>(Range is 0 thru 255)</p>
<p>• Sharpness Threshold Control</p>  <p>The image shows a slider control labeled 'Threshold' with a scale from 0 to 255. The slider knob is positioned approximately at the 125 mark.</p>	<p>Adjusts the point at which sharpening rules become active. Data below the threshold setting is passed unaffected.</p> <p>Higher settings allow for a more subtle sharpness enhancement (especially with content showing motion). Lower settings allow more content in general to be acted upon by the enhancement process.</p> <p>(Range is 0 thru 255)</p>
<p>• Noise Reduction Control</p>  <p>The image shows a slider control labeled 'Noise Reduction' with a scale from 0 to 63. The slider knob is positioned approximately at the 32 mark.</p>	<p>Adjusts the amount of statistical low-pass filtering applied to the data. Using this control, regular pattern noise artifacts from the sharpening process can be reduced, resulting in subjectively smoother raster backgrounds and detail boundaries.</p> <p>(Range is 0 thru 63)</p>

Table 3-2 9931-EMDE Function Menu List — continued



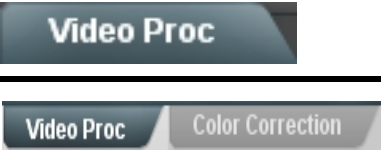

	<p>Option </p> <p>Provides color corrector functions for the individual RGB channels for the card program video path. (Option +COLOR)</p>
<p>• Color Corrector</p> 	<p>Color Corrector (On/Off) provides master on/off control of all Color Corrector functions.</p> <ul style="list-style-type: none"> • When set to Off, all processing is bypassed. • When set to On, currently displayed parameters settings take effect.
<p>• Reset to Unity</p> 	<p>Reset to Unity provides unity reset control of all Color Corrector functions.</p> <p>When Confirm is clicked, a Confirm? pop-up appears, requesting confirmation.</p> <ul style="list-style-type: none"> • Click Yes to proceed with the unity reset. • Click No to reject unity reset.
<p>• Luma Gain R-G-B controls</p>  <p>• Black Gain R-G-B controls</p>  <p>• Gamma Factor R-G-B controls</p> 	<p>Separate red, green, and blue channels controls for Luma Gain, Black Gain, and Gamma curve adjustment.</p> <p>Gain controls provide gain adjustment from 0.0 to 200.0% range in 0.1% steps (unity = 100.0)</p> <p>Gamma controls apply gamma curve adjustment in 0.125 to 8.000 range in thousandths steps (unity = 1.000)</p> <p>Each of the three control groups (Luma, Black, and Gamma) have a Gang Column button which allows settings to be proportionally changed across a control group by changing any of the group's controls.</p>

Table 3-2 9931-EMDE Function Menu List — continued



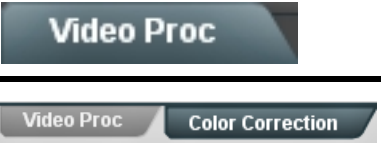

	<p>(continued)</p>
<ul style="list-style-type: none"> • Black Hard Clip 	<p>Applies black hard clip (limiting) at specified percentage. (-6.8% to 50.0%; null = -6.8%)</p>
<ul style="list-style-type: none"> • White Hard Clip 	<p>Applies white hard clip (limiting) at specified percentage. (50.0% to 109.1%; null = 109.1%)</p>
<ul style="list-style-type: none"> • White Soft Clip 	<p>Applies white soft clip (limiting) at specified percentage. (50.0% to 109.1%; null = 109.1%)</p>
<ul style="list-style-type: none"> • Chroma Saturation Clip 	<p>Applies chroma saturation clip (limiting) chroma saturation at specified percentage. (50.0% to 160.0%; null = 160.0%)</p>

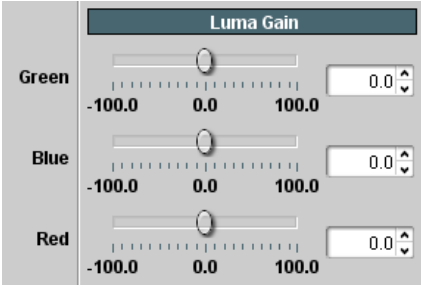
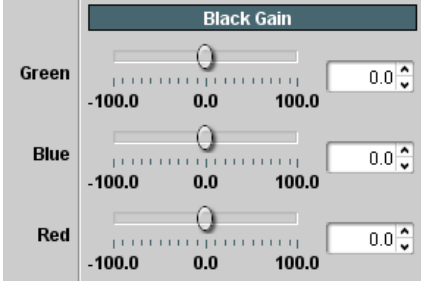
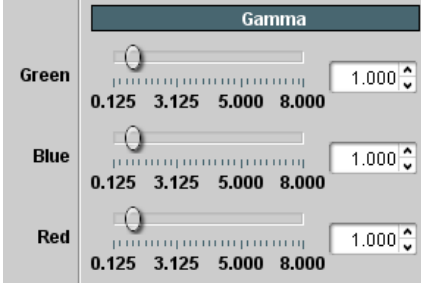
Table 3-2 9931-EMDE Function Menu List — continued

Timecode

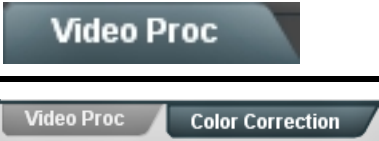
Provides timecode data extraction from various sources, and provides formatting and re-insertion controls for inserting the timecode into the output video.

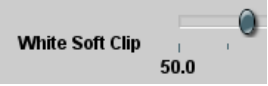
Shown below is an example in which received SDI video with SDI VITC waveform timecode is to be converted to SDI ATC_VITC timecode data. Each Timecode control is fully described on the pages that follow.

525i 5994
w/ VITC
Waveform

→ 9931-EMDE →

525i 5994
w/ ATC_VITC

Reference VITC Status	05:49:08:20.1
Input VITC Status	05:49:08:19.1
Input ATC_LTC Status	Not Present
Input ATC_VITC Status	Not Present

Source Priority 1	Input VITC
Source Priority 2	Input ATC_VITC
Source Priority 3	Reference VITC
Source Priority 4	Free Run

A Noting that the incoming video contains VITC waveform timecode data (as shown in the status display), set the Source Priority drop-down lists to include VITC Waveform timecode data (**SDI VITC**) as a choice. This extracts VITC Waveform timecode data from the incoming video.

B In this example, it is desired to provide SD ATC_VITC timecode data in the output video. As such, set **SD ATC VITC Insertion** to **Enabled**.

SD ATC_VITC Insertion	Enabled
SD ATC Insertion Line	13 - SMPTE 12M-2-2008 Recommended

In the example here, the line numbers are set to the default SMPTE 12M-2-2008 recommended value.

9931-EMDE-OM (V1.18)

9931-EMDE PRODUCT MANUAL

3-15

Table 3-2 9931-EMDE Function Menu List — continued

<div style="background-color: #333; color: white; padding: 5px; text-align: center; font-weight: bold;">Timecode</div>	(continued)																					
<p>• Timecode Source Status Displays</p> <table border="1" style="width: 100%; border-collapse: collapse;"> <tr> <td style="background-color: #eee;">Reference VITC Status</td> <td>06:09:15:06.0</td> </tr> <tr> <td style="background-color: #eee;">Input VITC Status</td> <td>06:09:15:05.0</td> </tr> <tr> <td style="background-color: #eee;">Input ATC_LTC Status</td> <td>Not Present</td> </tr> <tr> <td style="background-color: #eee;">Input ATC_VITC Status</td> <td>06:09:15:05.0 Field 1 Line 13, Field 2 Line 278</td> </tr> </table>	Reference VITC Status	06:09:15:06.0	Input VITC Status	06:09:15:05.0	Input ATC_LTC Status	Not Present	Input ATC_VITC Status	06:09:15:05.0 Field 1 Line 13, Field 2 Line 278	<p>Displays the current status and contents of the received timecode formats shown to the left.</p> <ul style="list-style-type: none"> • If a format is receiving timecode data, the current content (timecode running count and line number) is displayed. • If a format is not receiving timecode data, Not Present is displayed. 													
Reference VITC Status	06:09:15:06.0																					
Input VITC Status	06:09:15:05.0																					
Input ATC_LTC Status	Not Present																					
Input ATC_VITC Status	06:09:15:05.0 Field 1 Line 13, Field 2 Line 278																					
<p>• Incoming ATC Packet Removal Control</p> <div style="border: 1px solid #ccc; padding: 5px; background-color: #f0f0f0;"> <p style="margin: 0;">Incoming ATC Packet Removal Disabled</p> </div>	<p>Enables or disables removal of existing input video ATC timecode packets from the output. This allows removal of undesired existing timecodes from the output, resulting in a “clean slate” where only desired timecodes are then re-inserted into the output. (For example, if both SDI ATC_VITC and ATC_LTC are present on the input video, and only ATC_LTC is desired, using the Removal control will remove both timecodes from the output. The ATC_LTC timecode by itself can then be re-inserted on the output using the other controls discussed here.)</p>																					
<p>• Source Priority</p> <div style="border: 1px solid #ccc; padding: 5px; background-color: #f0f0f0;"> <p>Source Priority 1 Free Run ▼</p> <div style="border: 1px solid #ccc; padding: 2px; margin: 2px 0;"> <p>Free Run</p> <p>Reference VITC</p> <p>Input VITC</p> <p>Input ATC_LTC</p> <p>Input ATC_VITC</p> <p>Disable Output</p> </div> <p style="text-align: center;">⋮</p> <p>Source Priority 4 Reference VITC ▼</p> </div>	<p>Selects the priority assigned to each supported received format.</p> <p>Source Priority 1 thru Source Priority 4 select the preferred format to be used in descending order (i.e., Source Priority 2 selects the second-most preferred format, and so on. See example below.)</p> <div style="text-align: center;"> <p>The diagram shows a block labeled 'TC' (Timecode). Two arrows enter from the left: '525i Input VITC (1st priority)' and 'Reference VITC (2nd priority)'. An arrow labeled 'HD/SD SDI IN' also enters the top of the block. An arrow labeled 'SDI OUT' exits the right side of the block, pointing to '525i (w/ ATC_VITC)'. A dashed line connects the 'TC' block to the 'SDI OUT' arrow.</p> </div> <p>In this example, Input VITC 1st priority selection selects SDI VITC (received on SDI input) over reference VITC (received on frame reference) regardless of video input material source to be processed by the card.</p> <p>The selected timecode source is embedded on the SDI video output (in this example, 720p) using the selected line number. In this example, if the SDI VITC on the SDI input becomes unavailable, the card then uses the reference VITC data received on the frame reference.</p>																					
<p>Note: Disable Output setting should be used with care. If Disable Output is selected with alternate intended format(s) set as a lower priority, the card will indeed disable all timecode output should the ordinate preferred format(s) become unavailable. Typically, choices other than Disable should be used if a timecode output is always desired, with Disable only being used to remove all timecode data.</p> <div style="display: flex; justify-content: space-between; align-items: flex-start;"> <div style="width: 45%;"> <p>In this example, even though and ATC_LTC could be available to substitute for ATC_VITC not being present, the card will revert to no timecode output since the choice of Disable Output “out-prioritizes” ATC_LTC with these settings.</p> </div> <div style="width: 50%; border: 1px solid #ccc; padding: 5px; background-color: #f0f0f0;"> <table style="width: 100%; border-collapse: collapse;"> <tr> <td style="width: 20%;">Source Priority 1</td> <td style="border: 1px solid #ccc; padding: 2px;">Input VITC</td> <td style="width: 20%;"></td> <td style="border: 1px solid #ccc; padding: 2px;">Input VITC</td> <td style="width: 20%;"></td> <td rowspan="4" style="vertical-align: middle; padding-left: 10px;"> The choices shown here will allow ATC_LTC to “out-prioritize” Disable Output if ATC_VITC is not available. </td> </tr> <tr> <td>Source Priority 2</td> <td style="border: 1px solid #ccc; padding: 2px;">Input ATC_VITC</td> <td></td> <td style="border: 1px solid #ccc; padding: 2px;">Input ATC_VITC</td> <td></td> </tr> <tr> <td>Source Priority 3</td> <td style="border: 1px solid #ccc; padding: 2px;">Disable Output</td> <td></td> <td style="border: 1px solid #ccc; padding: 2px;">Input ATC_LTC</td> <td></td> </tr> <tr> <td>Source Priority 4</td> <td style="border: 1px solid #ccc; padding: 2px;">Input ATC_LTC</td> <td></td> <td style="border: 1px solid #ccc; padding: 2px;">Disable Output</td> <td></td> </tr> </table> </div> </div>		Source Priority 1	Input VITC		Input VITC		The choices shown here will allow ATC_LTC to “out-prioritize” Disable Output if ATC_VITC is not available.	Source Priority 2	Input ATC_VITC		Input ATC_VITC		Source Priority 3	Disable Output		Input ATC_LTC		Source Priority 4	Input ATC_LTC		Disable Output	
Source Priority 1	Input VITC		Input VITC		The choices shown here will allow ATC_LTC to “out-prioritize” Disable Output if ATC_VITC is not available.																	
Source Priority 2	Input ATC_VITC		Input ATC_VITC																			
Source Priority 3	Disable Output		Input ATC_LTC																			
Source Priority 4	Input ATC_LTC		Disable Output																			

Table 3-2 9931-EMDE Function Menu List — continued

<div style="background-color: #333; color: white; padding: 5px; text-align: center; font-weight: bold;">Timecode</div>	(continued)
<p>• Reference Source Select</p> 	<p>For Reference VITC timecode choice used for Source Priority above, selects reference VITC source from the choices shown to the left.</p>
<p>• Output Status Display</p> 	<p>Displays the current content and source being used for the timecode data as follows:</p>  <ul style="list-style-type: none"> • Output status OK (in this example, SDI VITC timecode received and outputted).  <ul style="list-style-type: none"> • Timecode Insertion button set to Disabled; output insertion disabled. <p>Note:</p> <ul style="list-style-type: none"> • If timecode is not available from Source Priority selections performed, timecode on output reverts to Free Run (internal count) mode. • Because the 1's digit of the display Frames counter goes from 0 to 29, the fractional digit (along with the 1's digit) indicates frame count as follows: <ul style="list-style-type: none"> 0.0 Frame 0 0.1 Frame 1 1.0 Frame 2 1.1 Frame 3 • • • 29.1 Frame 59
<p>• Offset Controls</p>  <hr/> 	<p>Allows the current timecode count to be advanced or delayed on the output video.</p> <ul style="list-style-type: none"> • Offset Advance or Delay selects offset advance or delay. • Offset Field delays or advances or delays timecode by one field. • Offset Frame delays or advances or delays timecode by up to 5 frames. <p>Note: Default settings are null, with both controls set at zero as shown.</p>
<p>Note:</p> <ul style="list-style-type: none"> • Although the output line drop-down on the controls described below will allow a particular range of choices, the actual range is automatically clamped (limited) to certain ranges to prevent inadvertent conflict with active picture area depending on video format. See Ancillary Data Line Number Locations and Ranges (p. 3-9) for more information. • The card does not check for conflicts on a given line number. Make certain the selected line is available and carrying no other data. 	

Table 3-2 9931-EMDE Function Menu List — continued

<div style="text-align: center; background-color: #333; color: white; padding: 5px; border: 1px solid black;"> <h2 style="margin: 0;">Timecode</h2> </div>	<p>(continued)</p>
<p>• SD VITC Waveform Insertion Controls</p> <div style="border: 1px solid #ccc; padding: 5px; background-color: #f9f9f9;"> <p>SD VITC Waveform Output 1 Line Number <input type="text" value="14"/></p> <p>SD VITC Waveform Output 2 Line Number <input type="text" value="16"/></p> <p style="text-align: right;">SD VITC Waveform Insertion <input type="button" value="Enabled"/></p> </div>	<p>For SD output, enables or disables SD VITC waveform timecode insertion into the output video, and selects the VITC1 and VITC2 line numbers (6 thru 22) where the VITC waveform is inserted.</p> <p>Note:</p> <ul style="list-style-type: none"> • If only one output line is to be used, set both controls for the same line number. • SD VITC Waveform Insertion control only affects VITC waveforms inserted (or copied to a new line number) by this function. An existing VITC waveform on an unscaled SD SDI stream is not affected by this control and is passed on an SDI output.
<p>• SD ATC Insertion Control</p> <div style="border: 1px solid #ccc; padding: 5px; background-color: #f9f9f9;"> <p>SD ATC_VITC Insertion <input type="button" value="Enabled"/></p> <p>SD ATC Insertion Line <input type="text" value="13 - SMPTE 12M-2-2008 Recommended"/></p> </div>	<p>For SD output, enables or disables SD ATC_VITC timecode insertion into the output video, and selects the line number for ATC_VITC.</p>
<p>• HD ATC_LTC Insertion Control</p> <div style="border: 1px solid #ccc; padding: 5px; background-color: #f9f9f9;"> <p>HD ATC_LTC Insertion <input type="button" value="Enabled"/></p> <p>HD ATC_LTC Insertion Line <input type="text" value="10 - SMPTE 12M-2-2008 Recommended"/></p> </div>	<p>For HD output, enables or disables ATC_LTC timecode insertion into the output video, and selects the line number for ATC_LTC timecode data.</p>
<p>• HD ATC_VITC Insertion Control</p> <div style="border: 1px solid #ccc; padding: 5px; background-color: #f9f9f9;"> <p>HD ATC_VITC Insertion <input type="button" value="Enabled"/></p> <p>HD ATC_VITC Insertion Line Field 1 <input type="text" value="9 - SMPTE 12M-2-2008 Recommended"/></p> <p>HD ATC_VITC Insertion Line Field 2 <input type="text" value="8 (571) - SMPTE 12M-2-2008 Recommended"/></p> </div>	<p>For HD output, enables or disables ATC_VITC timecode insertion into the output video, and selects the line number for ATC_VITC1 and ATC_VITC2.</p> <p>Note: If only one output line is to be used, set both controls for the same line number.</p>
<p>• ATC_VITC Legacy Support Control</p> <div style="border: 1px solid #ccc; padding: 5px; background-color: #f9f9f9;"> <p>ATC VITC Legacy Support <input type="button" value="Disabled"/></p> </div>	<p>When enabled, accommodates equipment requiring ATC_VITC packet in both fields as a "field 1" packet (non-toggling).</p> <p>Note: Non-toggling VITC1 and VITC2 packets do not conform to SMPTE 12M-2-2008 preferences. As such, ATC_VITC Legacy Support should be enabled only if required by downstream equipment.</p>
<p>• Free Run Timecode Controls</p> <div style="border: 1px solid #ccc; padding: 5px; background-color: #f9f9f9;"> <p>Free Run Hours <input type="text" value="7"/></p> <p>Free Run Minutes <input type="text" value="0"/></p> <p>Free Run Seconds <input type="text" value="0"/></p> <p>Apply Free Run Values <input type="button" value="Confirm"/></p> </div>	<p>Allows an initial (starting) count to be applied to output video timecode when Free Run insertion is enabled.</p> <p>Note:</p> <ul style="list-style-type: none"> • Initialization can only be applied when card is outputting Free Run timecode (as shown by Output Status displaying "Free Run"). • If failover to Free Run occurs due to loss of external timecode(s), the Free Run count assumes its initial count from the last valid externally supplied count.
<p>Note: Option Option +LTC provides timecode receive and send as LTC via card audio interfaces and a card RS-485 COM port. If your card is licensed for option +LTC, refer to Manual Supplement OPT-SW-F3GLTC-MS that is supplied with this manual.</p>	

Table 3-2 9931-EMDE Function Menu List — continued

	<p>Provides support for closed captioning setup.</p>										
<p>• Closed Captioning Input Status</p> <div style="border: 1px solid gray; padding: 5px; margin-bottom: 10px;"> <p>Input Status CDP Packet on Line 16</p> <p>HD packet-based display</p> </div> <div style="border: 1px solid gray; padding: 5px;"> <p>Input Status SD Caption Waveform Detected on Line 21</p> <p>SD waveform-based display</p> </div>	<p>Displays incoming Closed Captioning status as follows:</p> <ul style="list-style-type: none"> • If closed captioning is present, a message similar to the example shown left is displayed. Also displayed is the VANC line number of the incoming closed captioning packet (or SD waveform-based VANC line number). • If no closed captioning is present in the video signal, Not Present or Disabled is displayed. <p>Note: • Packet closed captioning status Captioning Rejected Due To message can appear due to the items described below. The closed captioning function assesses <i>cdp_identifier</i>, <i>cdp_frame_rate</i>, <i>ccdata_present</i>, and <i>caption_service_active</i> items contained in the packet header to make the determinations listed below. Refer to CEA-708-B for more information.</p> <ul style="list-style-type: none"> • The closed captioning function does not support PAL closed captioning standards. <table border="1" data-bbox="781 758 1430 1262"> <thead> <tr> <th>Message</th> <th>Description</th> </tr> </thead> <tbody> <tr> <td>Unsupported Frame Rate</td> <td>Film rate closed-captioning (either as pass-through or up/down conversion) is not supported by the card.</td> </tr> <tr> <td>Data Not Present</td> <td>Packet is marked from closed captioning source external to the card that no data is present.</td> </tr> <tr> <td>Service Inactive</td> <td>Packet is marked from closed captioning source external to the card indicating packet does not contain active caption service.</td> </tr> <tr> <td>No Data ID</td> <td>Packet from closed captioning source external to the card is not properly identified with 0x9669 as the first word of the header (unidentified packet).</td> </tr> </tbody> </table>	Message	Description	Unsupported Frame Rate	Film rate closed-captioning (either as pass-through or up/down conversion) is not supported by the card.	Data Not Present	Packet is marked from closed captioning source external to the card that no data is present.	Service Inactive	Packet is marked from closed captioning source external to the card indicating packet does not contain active caption service.	No Data ID	Packet from closed captioning source external to the card is not properly identified with 0x9669 as the first word of the header (unidentified packet).
Message	Description										
Unsupported Frame Rate	Film rate closed-captioning (either as pass-through or up/down conversion) is not supported by the card.										
Data Not Present	Packet is marked from closed captioning source external to the card that no data is present.										
Service Inactive	Packet is marked from closed captioning source external to the card indicating packet does not contain active caption service.										
No Data ID	Packet from closed captioning source external to the card is not properly identified with 0x9669 as the first word of the header (unidentified packet).										
<p>• Closed Captioning Insert (Processed) / Removal Controls</p> <div style="border: 1px solid gray; padding: 5px; margin-bottom: 10px;"> <p>Process Closed Captioning <input checked="" type="checkbox"/> Enabled</p> </div> <div style="border: 1px solid gray; padding: 5px;"> <p>Incoming Packet Removal <input type="checkbox"/> Disabled</p> </div>	<p>Enables or disables Closed Captioning insertion on the output video as follows:</p> <ul style="list-style-type: none"> • Process Closed Captioning set to Enabled replaces incoming CDP with locally processed packets. This processing allows line number control, null packet insertion (if desired) and CGMS functions. (Control set to Enabled always removes incoming CDP and replaces it with the processed CDP.) • Incoming Packet Removal set to Enabled strips all CDP from output video (as long as Process Closed Captioning is not enabled). <p>Note: • Incoming CDP can be removed or passed unmodified. To use null packet insertion or (optional) CGMS functions, Process Closed Captioning must be set to Enabled.</p> <ul style="list-style-type: none"> • When Process Closed Captioning set to Enabled, closed captioning is set to standard default line number. See Ancillary Data Line Number Locations and Ranges (p. 3-9). (SD output is locked to line 21.) • The card does not check for conflicts on a given line number. Make certain selected line is available and carrying no other data. 										

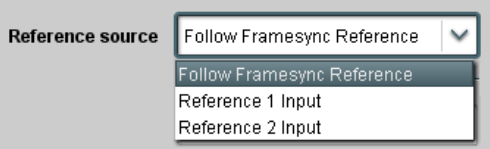
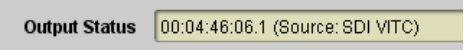
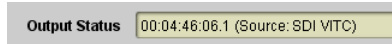
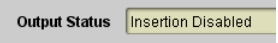
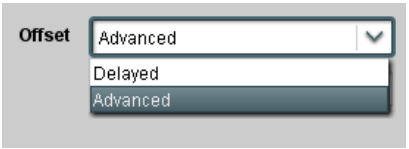
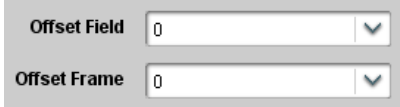
Table 3-2 9931-EMDE Function Menu List — continued





	<p>(continued)</p>
<p>• NULL CDP Insertion Control</p> 	<p>Enables or disables NULL CDP insertion when there are no incoming packets (default setting is Enabled setting which allows NULL CDP insertion even if no packets are incoming).</p>
<p>• Closed Captioning HD Output Line</p> 	<p>Selects the VANC line number (9 thru 41) for the closed caption data when the output is HD.</p> <p>Note:</p> <ul style="list-style-type: none"> • Although the output line drop-down will allow any choice within the 9 thru 41 range, the actual range is automatically clamped (limited to) certain ranges to prevent inadvertent conflict with active picture area depending on video format. See Ancillary Data Line Number Locations and Ranges (p. 3-9) for more information. • The card does not check for conflicts on a given line number. Make certain the selected line is available and carrying no other data unless existing metadata is to be intentionally overwritten.
<p>Option  The following CGMS Settings controls appear only on card licensed with option +CGMS.</p>	
<p>• CGMS Settings (Option +CGMS)</p> 	<p>Displays the current status of CGMS insertion:</p> <ul style="list-style-type: none"> • CGMS insertion disabled indicates CGMS has been manually disabled using control shown below. • Error: CGMS insertion requires enabling Closed Captioning indicates CGMS has been set for insertion, but closed captioning processing (insertion) has been manually disabled by having Process Closed Captioning set to Disabled. Make certain Process Closed Captioning is enabled if CGMS is to be used. • Insertion OK indicates CGMS is enabled and being inserted.
<p>• CGMS-A Copy Permit Settings</p> 	<p>Selects the CGMS-A insertion the copy protect level to be embedded in the message (as per the choices shown).</p>
<p>• CGMS-A Copy Permit Settings</p> 	<p>Selects the CGMS-A PSP type and definition bits carried on the analog output VBI.</p> <ul style="list-style-type: none"> • Analog Protection selects PSP type (or removes APS).i • Analog Source Bit and Redistribution Control Descriptor enables or disables insertion of source and redistribution control bits to be used by downstream devices. • Insert Interval sets the insert repeat interval of the CGMS-A insertion into VBI. • Enable CGMS provides an overall enable/disable control for the CGMS insertion function.

Table 3-2 9931-EMDE Function Menu List — continued



	<p>Provides video frame sync/delay control and output control/loss of program video failover selection controls.</p>
<p>• Framesync Enable</p> 	<p>Selects Frame Sync functions from the choices shown to the left and described below.</p> <ul style="list-style-type: none"> • Free Run: Output video is locked to the card's internal clock. Output video is not locked to external reference. • Lock to Reference: Output video is locked to external reference received on the frame reference bus. Default uses Ext Ref 1 frame bus, with failover to Ext Ref 2 in the event valid reference signal is not present on Ext Ref 1. (External reference signals Reference 1 and Reference 2 are distributed to the card and other cards via an 8320 frame bus.) <ul style="list-style-type: none"> Note: If valid reference is not received, the  Reference Invalid indication appears in the Card Info status portion of DashBoard™, indicating invalid frame sync reference error. • Lock to Input: Uses the program video input video signal as the reference standard. <ul style="list-style-type: none"> Note: If Lock to Input is used for framesync, any timing instability on the input video will result in corresponding instability on the output video.
<p>• Initial Startup Format Select</p> 	<p>Selects a synthesized frame sync format/rate to be invoked (from the choices shown to the left) in the time preceding stable lock to external reference.</p> <p>Set this control to that of the intended external reference to help ensure smoothest frame sync locking. This control also sets the card test pattern format where the card's initial output at power-up is the internal pattern instead of program video.</p>
<p>• Program Video Output Mode Select</p> 	<p>Provides a convenient location to select between card program video output and other technical outputs from the choices shown to the left and described below.</p> <ul style="list-style-type: none"> • Input Video – card outputs input program video (or loss of signal choices described below). • Flat Field (Black) – card outputs black flat field. • Freeze – card outputs last frame having valid SAV and EAV codes. • Test Pattern – card outputs standard technical test pattern (pattern is selected using the Pattern drop-down described below).
<p>• Loss of Input Signal Selection</p> 	<p>In the event of program input video Loss of Signal (LOS), determines action to be taken as follows:</p> <ul style="list-style-type: none"> • Disable Outputs: Disable program video SDI outputs. • Flat Field (Black) – go to black flat field on program video output. • Freeze – go to last frame having valid SAV and EAV codes on program video output. • Test Pattern – go to standard technical test pattern on program video output (pattern is selected using the Pattern drop-down described below).

Table 3-2 9931-EMDE Function Menu List — continued

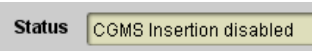
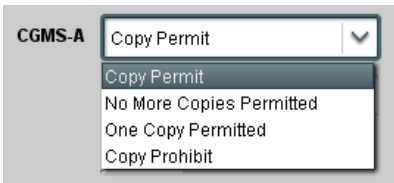
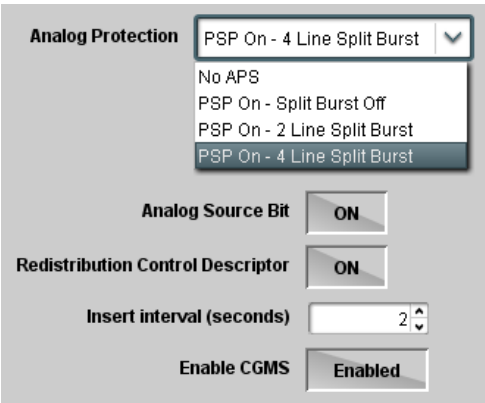

<div style="background-color: #333; color: white; padding: 5px; text-align: center; font-weight: bold;">Framesync</div>	(continued)
<p>• Pattern Select</p> 	<p>Provides a choice of standard technical patterns (shown to the left) when Test Pattern is invoked.</p>
<p>• Output Video Reference Offset Controls</p> 	<p>With framesync enabled, provides the following controls for offsetting the output video from the reference:</p> <ul style="list-style-type: none"> • Vertical (Lines) – sets vertical delay (in number of lines of output video) between the output video and the frame sync reference. (Positive values provide delay; negative values provide advance) <p>(Range is -1124 thru 1124 lines; null = 0 lines.)</p> <ul style="list-style-type: none"> • Horizontal (µs) – sets horizontal delay (in µs of output video) between the output video and the frame sync reference. (Positive values provide delay; negative values provide advance) <p>(Range is -64 thru 64 µsec; null = 0.000 µsec.)</p> <p>Note: Offset advance is accomplished by hold-off of the reference-directed release of the frame, thereby effectively advancing the program video relative to the reference.</p>
<p>• Minimum Latency Frames Control</p> 	<p>When Framesync is enabled, specifies the smallest amount of latency allowed by the frame sync (latency measurement in output video frames). The frame sync will not output a frame unless the specified number of frames are captured in the buffer. The operational latency of the frame sync is always between the specified minimum latency and minimum latency plus one frame (not one field).</p> <p>Note: Due to card memory limits, the maximum available Minimum Latency Frames is related to the output video format selected. For example, with a 525i59.94 output, the practical maximum limit is 13.</p> <p>When using this control, be sure to check the Framesync Status display as follows:</p> <div style="border: 1px solid #ccc; padding: 2px; margin-bottom: 5px;"> Framesync Status On </div> <ul style="list-style-type: none"> • Latency frames selection within limits. <div style="border: 1px solid #ccc; padding: 2px; margin-bottom: 5px;"> Framesync Status Minimum Latency Frames set to 3 the maximum amount for this standard </div> <ul style="list-style-type: none"> • Latency frames selection exceeds limits.

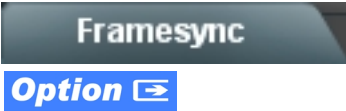
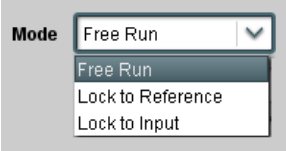
Table 3-2 9931-EMDE Function Menu List — continued

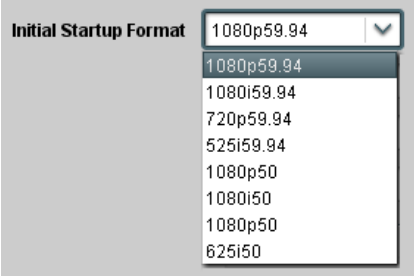
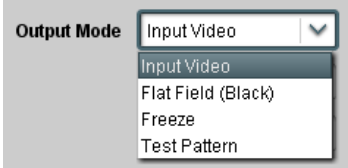
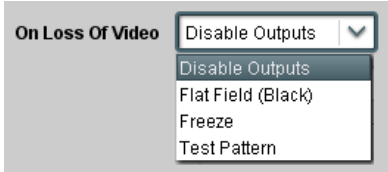
<div style="background-color: #333; color: white; padding: 5px; text-align: center; font-weight: bold;">Framesync</div>	(continued)
<ul style="list-style-type: none"> • Video Delay Display <div style="border: 1px solid #ccc; padding: 5px; margin-top: 10px;"> Video Delay 0.06 ms / 0 Frames 1 lines </div>	<p>Displays the current input-to-output video delay (in msec units) as well as in terms of Frames/fractional frame (in number of lines).</p>
<ul style="list-style-type: none"> • Framesync Status Display <div style="border: 1px solid #ccc; padding: 5px; margin-top: 10px;"> Status Running - Reference 1 </div>	<p>Displays the current framesync status as follows:</p> <div style="border: 1px solid #ccc; padding: 2px; margin-bottom: 5px;"> Status Running - Reference 1 </div> <ul style="list-style-type: none"> • Framesync status running from indicated frame reference. <div style="border: 1px solid #ccc; padding: 2px; margin-bottom: 5px;"> Status Off no valid reference detected </div> <ul style="list-style-type: none"> • Improper or missing framesync reference. <div style="border: 1px solid #ccc; padding: 2px; margin-bottom: 5px;"> Status Running - Local Clock </div> <ul style="list-style-type: none"> • Framesync derived using card local clock. <div style="border: 1px solid #ccc; padding: 2px; margin-bottom: 5px;"> Status Minimum Latency Frames set to 3 the maximum amount for this standard </div> <ul style="list-style-type: none"> • Latency frames selection exceeds limits. <p style="text-align: center;">Note: See Minimum Latency Frames Control in Framesync (p. 3-21) for more information about this message.</p>
<p>Note: Audio timing offset from video is performed using the delay controls on the Audio Bus Input Routing/Controls tab. Refer to Audio Bus Input Routing/Controls (p. 3-32) for these controls.</p>	

Table 3-2 9931-EMDE Function Menu List — continued

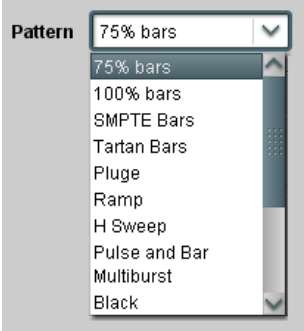
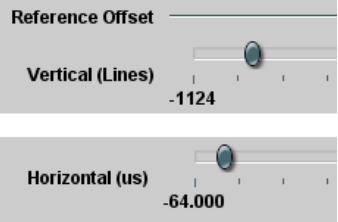



<div style="text-align: center;">  </div> <hr/> <div style="display: flex; justify-content: space-around;"> AFD/WSSM AFD Map </div>	<p>Allows assignment of AFD, WSS and/or VI codes to the SDI output video, and allows custom ARC settings to be applied for each code. Also allows translations between WSS, VI, and AFD active ARC formats.</p>
<div style="border: 1px solid black; padding: 10px;"> <h3 style="margin-top: 0;">Without AFD</h3> <div style="display: flex; justify-content: space-between; align-items: center; margin-top: 20px;"> <div style="width: 30%;"> <p>NTSC-Coded (4:3) 1080i Video Signal</p> <p>NTSC-Coded image on 16:9 display shows letterbox cropping</p>  </div> <div style="width: 30%; text-align: center;"> <div style="border: 1px solid black; padding: 5px; margin-bottom: 5px;">Up-Conversion to 16:9</div> <p>→</p> </div> <div style="width: 30%;"> <p>1080i Video Signal with 16:9 uncorrected signal</p> <p>Uncorrected up-conversion results in "postage stamp" effect with both letterbox and sidebars visible on 16:9 display</p>  </div> </div> </div> <div style="border: 1px solid black; padding: 10px; margin-top: 20px;"> <h3 style="margin-top: 0;">With AFD</h3> <div style="display: flex; justify-content: space-between; align-items: center; margin-top: 20px;"> <div style="width: 30%;"> <p>NTSC-Coded (4:3) 1080i Video Signal with 1010 AFD Code</p> <p>NTSC-Coded image on 16:9 display shows letterbox cropping</p>  </div> <div style="width: 30%; text-align: center;"> <div style="border: 1px solid black; padding: 5px; margin-bottom: 5px;">1010 AFD Code Received and Applied to Scaler</div> <p>→</p> </div> <div style="width: 30%; text-align: center;"> <div style="border: 1px solid black; padding: 5px; margin-bottom: 5px;">Up-Conversion to 16:9</div> <p>→</p> </div> <div style="width: 30%;"> <p>1080i Video Signal with 16:9 corrected signal</p> <p>AFD Corrected up-conversion results in intended image area properly visible on 16:9 display</p>  </div> </div> </div>	

Table 3-2 9931-EMDE Function Menu List — continued

<div style="background-color: #333; color: white; padding: 5px; display: inline-block; border: 1px solid black;">AFD/WSS/VI</div> <hr style="border: 1px solid black;"/> <div style="display: flex; justify-content: space-around; width: 100%;"> <div style="background-color: #ccc; padding: 2px; border: 1px solid black;">AFD/WSS/VI</div> <div style="background-color: #ccc; padding: 2px; border: 1px solid black;">AFD Map</div> </div>	<p>(continued)</p>
<p>Shown below is an example in which received 625i50 SDI video is being up-converted to 720p50. The settings shown in the example below provide for directing the scaler to re-aspect the 4:3 input video to full, centered 16:9 re-aspecting, and mark the output video with the AFD code representing the new re-aspected H/V format.</p> <div style="display: flex; align-items: center;"> <div style="flex: 1;"> <p>625i50 Video Input w/ WSS ETSI = 5 (4:3 -> 16:9)</p> </div> <div style="flex: 2; text-align: center;"> </div> </div> <p>Note: Active ARC control available only with card equipped with scaler. On non-scaler card, ARC control/convert function only manipulates output SDI ARC codes and has no local effect on card output aspect ratio.</p>	
<p>(A) Noting that the incoming video contains WSS coding, Trigger on WSS is set to ETSI, with other choices set to Off. The settings here allow ARC to trigger only on an ETSI-coded WSS received code.</p>	<div style="border: 1px solid #ccc; padding: 5px; background-color: #f9f9f9;"> <p>Input</p> <p>AFD Status <input type="radio"/> Not Present</p> <p>WSS Status <input checked="" type="radio"/> Detected, 4x3 0100 Letterbox 16x9 Center</p> <p>VI Status <input type="radio"/> Not Present</p> <hr/> <p>Trigger on AFD <input type="text" value="Off"/></p> <p>Trigger on WSS <input type="text" value="ETSI"/></p> <p>Trigger on VI <input type="text" value="Off"/></p> </div>
<p>(B) In this example, it is desired to use the H/V re-aspecting inherent in the received video ARC, perform the re-aspecting with no modification, and output an AFD code representing the re-aspecting performed.</p> <p>As such, Force Input Mapping is set to Follow Trigger, thereby bypassing the Output ARC Cross-Matrix Map table and directly perform the re-aspecting defined by the received code (in this example, Letterbox 16x9). Also in this example, the scaler is directed to apply the output AFD re-aspecting by setting Scaler Follow AFD to Enabled.</p>	<div style="border: 1px solid #ccc; padding: 5px; background-color: #f9f9f9;"> <p>Force Input Mapping <input type="text" value="Follow Trigger"/></p> <hr/> <p>Scaler follow AFD <input checked="" type="checkbox"/> Enabled</p> </div>
<p>(C) In this example, since only AFD is to be outputted, AFD Output is set to Enabled, with WSS and VI choices set to Disabled.</p> <p>AFD Status shows AFD code now being outputted.</p> <p>The insertion line number (using its default value here), can be set using the AFD Output Line controls (for the progressive format in this example, the Field 1 control serves as the line number control).</p>	<div style="border: 1px solid #ccc; padding: 5px; background-color: #f9f9f9;"> <p>Output</p> <p>AFD Status <input checked="" type="radio"/> Enabled, 16x9 0100 Letterbox 16x9 Center</p> <p>WSS Status <input type="radio"/> Disabled or no valid mapping</p> <p>VI Status <input type="radio"/> Disabled or no valid mapping</p> <p>AFD Output <input type="text" value="Enabled"/></p> <p>WSS Output <input type="text" value="Disabled"/></p> <p>VI Output <input type="text" value="Disabled"/></p> <p>AFD Output Line Field 1 <input type="text" value="10"/></p> <p>AFD Output Line Field 2 <input type="text" value="22"/></p> </div>

Table 3-2 9931-EMDE Function Menu List — continued



	<p>AFD/WSS/VI sub-tab provides prioritized and gated input monitoring for AFD, WSS and/or VI formats. Also provides translation between input and output AFD, WSS, and VI ARC formats.</p>
<p>Note:</p> <ul style="list-style-type: none"> • Active ARC control available only with card equipped with scaler. On non-scaler card, ARC control/convert function only manipulates output SDI ARC codes and has no local effect on card output aspect ratio. • Line number control available only for AFD format. WSS and VI use fixed line numbers per applicable standards. • Some AFD codes are not supported in WSS and VI formats. Refer to AFD/WSS/VI Translation Matrix on page 328 for more information. 	
<p>• Input Format Status Displays</p> 	<p>Displays the current status and contents of the three supported ARC formats shown to the left.</p> <ul style="list-style-type: none"> • If a format is received, the current formatting code and description is displayed (as shown in the example). • If a format is not receiving data, Not Present is displayed.
<p>• Scaler AFD Enable</p> 	<p>(Scaler-equipped card only) Enables scaler to apply ARC settings provided by ARC controls in this function.</p> <ul style="list-style-type: none"> • Enabled sets the output aspect ratio to track with AFD settings performed in this tab, overriding any other scaler manual ARC control settings. • Disabled allows ARC coding processing performed in this tab, but does not apply ARC settings in scaler. <p>Note:</p> <ul style="list-style-type: none"> • This control also appears on the Scaler tab and is mutually ganged with the selection performed on either tab. • Scaler follows AFD functions only when a valid AFD output format is being generated and enabled. The scaler only observes AFD code commands, with the controls on this tab set to generate an AFD-coded output. WSS and/or VI formats must be translated to a supported AFD cross-translation for scaler active ARC to function when using WSS or VI input formats.
<p>• Input Mapping</p> 	<p>When received ARC code is received, applies H/V coding as follows:</p> <ul style="list-style-type: none"> • Follow Trigger – Uses the ARC coding inherent in the received triggering ARC. • 4x3 ARC Codes – For received triggering formats coded as 4x3, applies the H/V coding selected in this drop-down. • 16x9 ARC Codes – For received triggering formats coded as 16x9, applies the H/V coding selected in this drop-down. <p>Note: Settings performed here can be applied directly to the output video, or the settings applied here can be custom modified if desired for any of the 11 4x3 codes and any of the 11 16x9 codes available here using the AFD Map sub-tab. Refer to AFD/WSS/VI Translation Matrix on page 328 for more information and coding descriptions.</p>

Table 3-2 9931-EMDE Function Menu List — continued

<div style="text-align: center; border: 1px solid black; padding: 5px;"> AFD/WSS/VI </div> <div style="border: 1px solid black; padding: 2px; margin-top: 5px;"> AFD/WSS/VI AFD Map </div>	<p>(continued)</p>
<p>• Input Triggering Controls</p> <div style="border: 1px solid gray; padding: 5px; margin-bottom: 5px;"> <p>Trigger on AFD <input type="text" value="Off"/></p> <p>Trigger on WSS <input type="text" value="Off"/></p> <p>Trigger on VI <input type="text" value="Off"/></p> <p>WSS/VI Priority <input type="text" value="WSS"/></p> </div>	<p>Individual ARC format input controls allow accepting or rejecting received ARC formats as follows:</p> <ul style="list-style-type: none"> • Trigger on AFD: <ul style="list-style-type: none"> • Off rejects AFD-coded triggering. • On allows trigger on AFD. • Trigger on WSS: <ul style="list-style-type: none"> • Off rejects WSS-coded triggering. • AFD allows triggering on AFD-coded WSS. • ETSI allows triggering on ETSI-coded WSS. • Trigger on VI: <ul style="list-style-type: none"> • Off rejects VI-coded triggering. • AFD allows triggering on AFD-coded WSS. • SMPTE allows triggering on SMPTE-coded WSS. <p>Note: If multiple formats are present on the input video, AFD preempts other formats, followed by WSS or VI (as set by the WSS/VI Priority control).</p>
<p>• Output Enable Controls</p> <div style="border: 1px solid gray; padding: 5px; margin-bottom: 5px;"> <p style="text-align: center;">Output</p> <hr/> <p>AFD Output <input type="text" value="Enabled"/></p> <p>WSS Output <input type="text" value="Disabled"/></p> <p>VI Output <input type="text" value="Disabled"/></p> </div>	<p>Individual ARC format input controls allow accepting or rejecting received ARC formats as follows:</p> <ul style="list-style-type: none"> • AFD Output: <ul style="list-style-type: none"> • Disable turns off AFD format on output. • Enable inserts AFD packet on output, and allows changing line number. • Follow Input Line inserts AFD packet on same line as received AFD line number (where applicable). • WSS Output: <ul style="list-style-type: none"> • Disable turns off WSS format on output. • AFD Enabled inserts AFD-coded WSS on output. • ETSI Enabled inserts ETSI-coded WSS on output. • VI Output: <ul style="list-style-type: none"> • Disable turns off WSS format on output. • AFD Enabled inserts AFD-coded VI on output. • SMPTE Enabled inserts SMPTE-coded VI on output.
<p>• Output Status Displays</p> <div style="border: 1px solid gray; padding: 5px; margin-bottom: 5px;"> <p style="text-align: center;">Output</p> <hr/> <p>AFD Status <input checked="" type="radio"/> Enabled, 16x9 1111 Protect 4x3</p> <p>WSS Status <input type="radio"/> Disabled or no valid mapping</p> <p>VI Status <input checked="" type="radio"/> Enabled, SMPTE 6 625/50/16x9</p> </div>	<p>Displays the current output status, coding, and H/V ratio for AFD, WSS, and VI formats.</p> <ul style="list-style-type: none"> • If a format is active and enabled (as set with the Output Enable controls), the code and H/V description is displayed. • If a format is not outputting data, Disabled is displayed. <p>Note:</p> <ul style="list-style-type: none"> • The code displayed shows the outputted code. If the code is modified by user settings performed in the AFD Map sub-tab, these changes are shown here. Refer to AFD Map sub-tab for more information. • As shown in the example, settings that result in invalid mapping across format translations will display Disabled. In these cases, no output is inserted for the format.
<p>• AFD Output Line Control</p> <div style="border: 1px solid gray; padding: 5px; margin-bottom: 5px;"> <p>AFD Output Line Field 1 <input type="text" value="10"/></p> <p>AFD Output Line Field 2 <input type="text" value="22"/></p> </div>	<p>Allows selecting the line location of the AFD data within the video signal Ancillary Data space.</p> <p>Note:</p> <ul style="list-style-type: none"> • The card does not check for conflicts on a given line number. Make certain the selected line is available and carrying no other data. • For progressive formats, the Field 1 control serves as the line number control.

Table 3-2 9931-EMDE Function Menu List — continued

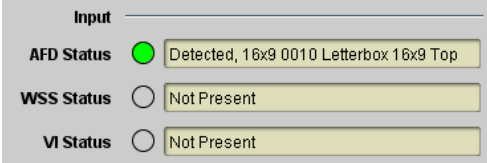
AFD/WSSM					(continued)					
AFD/WSSM		AFD Map								
AFD/WSS/VI Translation Matrix										
The table below lists valid translations between WSS, VI, and SMPTE 2016 AFD codes for both 4x3 and 16x9-coded frames.										
Input					Output					
AFD	WSS ETSI 625	WSS ETSI 525	VI	Description	AFD	WSS ETSI 625	WSS ETSI 525	VI	Description	
4:3 Coded	0010	4			4x3 Letterbox 16x9 Top	0010	4	0	1 (NTSC) 2 (PAL)	4x3 Letterbox 16x9 Top
	0011	2			4x3 Letterbox 14x9 Top	0011	2	0	1 (NTSC) 2 (PAL)	4x3 Letterbox 14x9 Top
	0100	5	2		4x3 Letterbox 16x9 Center	0100	5	2	1 (NTSC) 2 (PAL)	4x3 Letterbox 16x9 Center
	0101, 0110, 0111				Undefined					
	1000	0	0	0 1 (NTSC) 2 (PAL)	4x3 Coded Frame	1000	0	0	1 (NTSC) 2 (PAL)	4x3 Coded Frame
	1001				4x3 Center	1001	0	0	1 (NTSC) 2 (PAL)	4x3 Center
	1010	3			4x3 16x9 Center	1010	3	2	1 (NTSC) 2 (PAL)	4x3 16x9 Center
	1011	1			4x3 14x9 Center	1011	1	0	1 (NTSC) 2 (PAL)	4x3 14x9 Center
	1100			3, 4, 7	Reserved	1100		0	1 (NTSC) 2 (PAL)	Reserved
	1101	6			4x3 Protect 14x9	1101	6	0	1 (NTSC) 2 (PAL)	4x3 Protect 14x9
	1110				4x3 Letterbox 16x9; Protect 14x9 Center	1110		2	1 (NTSC) 2 (PAL)	4x3 Letterbox 16x9; Protect 14x9 Center
	1111				4x3 Letterbox 16x9; Protect 4x3 Center	1111		2	1 (NTSC) 2 (PAL)	4x3 Letterbox 16x9; Protect 4x3 Center
16:9 Coded	0010				16x9 Letterbox 16x9 Top	0010		1	5 (NTSC) 6 (PAL)	16x9 Letterbox 16x9 Top
	0011				16x9 Letterbox 14x9 Top	0011		1	5 (NTSC) 6 (PAL)	16x9 Letterbox 14x9 Top
	0100				16x9 Letterbox 16x9 Center	0100		1	5 (NTSC) 6 (PAL)	16x9 Letterbox 16x9 Center
	0101, 0110, 0111				Undefined					
	1000	7	1	0 5 (NTSC) 6 (PAL)	16x9 Coded Frame	1000	7	11	5 (NTSC) 6 (PAL)	16x9 Coded Frame
	1001				16x9 4x3 Center	1001		1	5 (NTSC) 6 (PAL)	16x9 4x3 Center
	1010				16x9 Center Protect 16x9	1010	7	1	5 (NTSC) 6 (PAL)	16x9 Center Protect 16x9
	1100				Reserved	1100		1	5 (NTSC) 6 (PAL)	Reserved
	1101				16x9 4x3 Protect 14x9	1101		1	5 (NTSC) 6 (PAL)	16x9 4x3 Protect 14x9
	1110				16x9 Protect 14x9	1110		1	5 (NTSC) 6 (PAL)	16x9 Protect 14x9
	1111				16x9 Protect 4x3	1111		1	5 (NTSC) 6 (PAL)	16x9 Protect 4x3

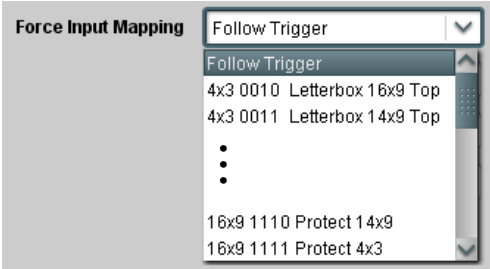
Note: Shaded cells indicate invalid translation which cannot be used.

Table 3-2 9931-EMDE Function Menu List — continued



AFD Map sub-tab allows bidirectionally re-aspecting from 4x3 frames to companion 16x9 frames, and allows customizing aspect ratio settings for the AFD codes (and the corresponding WSS and VI translation equivalents) supported by the card.

Input:4x3	V Zoom(60-200)	H Zoom(60-200)	Pan	Tilt	Output AFD Code
4x3 Letterbox 16x9 Top 0010	100.0	100.0	0.0	12.5	16x9 0010 Letterbox 16x9 Top
4x3 Letterbox 14x9 Top 0011	116.7	100.0	0.0	7.1	16x9 0011 Letterbox 14x9 Top
⋮					
4x3 Letterbox 16x9 Protect 4x3 1111	133.3	100.0	0.0	0.0	16x9 1111 Protect 4x3
Input:16x9	V Zoom(60-200)	H Zoom(60-200)	Pan	Tilt	Output AFD Code
16x9 Letterbox 16x9 Top 0010	75.0	100.0	0.0	-12.5	4x3 0010 Letterbox 16x9 Top
16x9 Letterbox 14x9 Top 0011	75.0	100.0	0.0	-7.1	4x3 0011 Letterbox 14x9 Top
⋮					
16x9 Protect 4x3 1111	100.0	133.0	0.0	0.0	4x3 1111 Letterbox 16x9 Protect 4x3

Separate control groups for 4x3 and 16x9 coded input frames allow custom ARC (as well as pan/tilt) for various coded frames.

- By default, each row is set for its companion re-aspected output, along with output AFD code for the companion output (i.e., 4x3 frames get re-aspected to a companion 16x9 re-aspecting and AFD code, and similarly 16x9 frames get re-aspected to a companion 4x3 re-aspecting and AFD code).

In this example, default settings provide the scaling and tilt factors to convert a 16x9-coded 0010 frame to its companion 4x3 0010 Letterbox 16x9 Top frame.

Input:16x9	V Zoom(60-200)	H Zoom(60-200)	Pan	Tilt	Output AFD Code
16x9 Letterbox 16x9 Top 0010	75.0	100.0	0.0	-12.5	4x3 0010 Letterbox 16x9 Top

Scaling and Pan/Tilt factors effect the re-aspecting and position offset here that result in a 4x3 0010 Letterbox 16x9 Top image when these defaults are applied.

The AFD coding representing the applied re-aspecting is applied to the output video.

- On cards **with** a scaler, when the scaler is set to **Scaler follow AFD** any V, H, pan, or tilt custom changes made here are directly applied to the output video.
- On cards **without** a scaler, only the Output AFD Code column appears (these cards can only mark the output signal with an AFD code, and do not perform any re-aspecting).

9931-EMDE-OM (V1.18)

9931-EMDE PRODUCT MANUAL

3-29

Table 3-2 9931-EMDE Function Menu List — continued

<div style="background-color: #333; color: white; padding: 5px; text-align: center; font-weight: bold;">Output Video</div>	<p>Provides an output video crosspoint between up to four SDI output ports and the card program video and auxiliary streams.</p>												
<p>• Output Video Crosspoint</p> <div style="border: 1px solid #ccc; background-color: #f0f0f0; padding: 10px; margin-top: 20px;"> <table style="width: 100%; border-collapse: collapse;"> <tr> <td style="padding: 2px;">SDI OUT A</td> <td style="padding: 2px;"><input type="radio"/> Program</td> <td style="padding: 2px;"><input checked="" type="radio"/> Input A Reclock</td> </tr> <tr> <td style="padding: 2px;">SDI OUT B</td> <td style="padding: 2px;"><input checked="" type="radio"/> Program</td> <td style="padding: 2px;"><input type="radio"/> Input A Reclock</td> </tr> <tr> <td style="padding: 2px;">SDI OUT C</td> <td style="padding: 2px;"><input checked="" type="radio"/> Program</td> <td style="padding: 2px;"><input type="radio"/> Input A Reclock</td> </tr> <tr> <td style="padding: 2px;">SDI OUT D</td> <td style="padding: 2px;"><input checked="" type="radio"/> Program</td> <td style="padding: 2px;"><input type="radio"/> Input A Reclock</td> </tr> </table> </div>	SDI OUT A	<input type="radio"/> Program	<input checked="" type="radio"/> Input A Reclock	SDI OUT B	<input checked="" type="radio"/> Program	<input type="radio"/> Input A Reclock	SDI OUT C	<input checked="" type="radio"/> Program	<input type="radio"/> Input A Reclock	SDI OUT D	<input checked="" type="radio"/> Program	<input type="radio"/> Input A Reclock	<p>For each SDI output port supported by the card, provides a crosspoint for routing program processed video, reclocked, or other video handled by the card.</p> <p>Note: Analog output controls (not shown) appear only on cards licensed for analog video output. If your card is licensed for analog video support, refer to Manual Supplement OPT-F3G-AN-MS that is supplied with this manual.</p> <p>In this example, reclock of SDI IN A is fed to SDI OUT A port, and buffered program video is fed to SDI OUT B thru SDI OUT D.</p>
SDI OUT A	<input type="radio"/> Program	<input checked="" type="radio"/> Input A Reclock											
SDI OUT B	<input checked="" type="radio"/> Program	<input type="radio"/> Input A Reclock											
SDI OUT C	<input checked="" type="radio"/> Program	<input type="radio"/> Input A Reclock											
SDI OUT D	<input checked="" type="radio"/> Program	<input type="radio"/> Input A Reclock											

Table 3-2 9931-EMDE Function Menu List — continued

Input Audio Status	Displays signal status and payload for embedded and discrete audio received by the card.
---------------------------	------------------------------------------------------------------------------------------

Individual signal status and peak level displays for embedded audio input pairs, and AES/analog input pairs (where licensed) as described below. AES pair status also shows sample rate.

- **Unlocked:** Indicates AES pair or embedded channel does not contain recognized audio PCM data.
 - **PCM:** Indicates AES pair or embedded channel contains recognized AES audio PCM data.
 - **Dolby E:** Indicates AES pair or embedded channel contains Dolby® E encoded data.
 - **Dolby Digital:** Indicates AES pair or embedded channel contains Dolby® Digital encoded data.
- Note:**
- Dolby status displays occur only for valid Dolby® signals meeting SMPTE 337M standard. If a Dolby pair is passed through the card without decoding, the signal is passed with all related gain controls locked out.
 - AES Dolby-encoded inputs that are routed directly to card optional Dolby decoder are detected as Dolby and are then routed via a special path that automatically bypasses SRC. However, AES inputs to other destinations (e.g., AES embedding) are first applied through SRC. These paths disable SRC if Dolby-encoded data is detected. To avoid a possible “Dolby noise burst” if an input on these paths changes from PCM to Dolby, it is recommended to set the AES SRC control for the pair to **SRC Off** for an AES input that is expected to carry a Dolby signal.
 - With **SRC** set to Off when receiving a PCM pair over an AES input, Status may display “NULL code 0, Line 0” or “Data” instead of the expected “PCM” message. The **Peak** field may also display “Data” instead of the dBFS levels for the pair. This issue is related only to the DashBoard display; the processing, control, and passthrough of PCM AES pairs is not affected in any way by this issue.

	Status	Peak	
Emb 1-2	PCM	-34.0 dBFS / -33.5 dBFS	
Emb 3-4	PCM	-20.1 dBFS / -20.1 dBFS	
Emb 5-6	PCM	-26.0 dBFS / -29.0 dBFS	
Emb 7-8	Dolby Digital	Data	
Emb 9-10	Dolby E, Line 233	Data	
Emb 11-12	PCM	< -150.0 dBFS / < -150.0 dBFS	
Emb 13-14	PCM	< -150.0 dBFS / < -150.0 dBFS	
Emb 15-16	PCM	< -150.0 dBFS / < -150.0 dBFS	

	Status	Peak	SRC
AES 1-2	PCM, 48000 Samples Per Second	-34.0 dBFS / -33.5 dBFS	SRC On
AES 3-4	PCM, 44100 Samples Per Second	-20.1 dBFS / -20.1 dBFS	SRC On
AES 5-6	Configured As Output	---	SRC On
AES 7-8	Configured As Output	---	SRC On
AES 9-10	Unlocked	---	SRC On
AES 11-12	Unlocked	---	SRC On
AES 13-14	Unlocked	---	SRC On
AES 15-16	Unlocked	---	SRC On

Note: After familiarizing yourself with the controls described in the audio routing/control sections that follow, see “Audio Routing with GPI Control Example” (p. 3-58) for a comprehensive example using these controls for multi-source audio routing.

Table 3-2 9931-EMDE Function Menu List — continued

Audio Bus Input Routing/Controls

Provides routing, gain, and individual/master audio-video delay controls for embedded, AES, analog, and downmix/flex mix input audio. These controls route selected audio sources onto the card 16-channel internal bus (which is used for all audio processing).

Input Routing

Input Downmixers

Input Flex

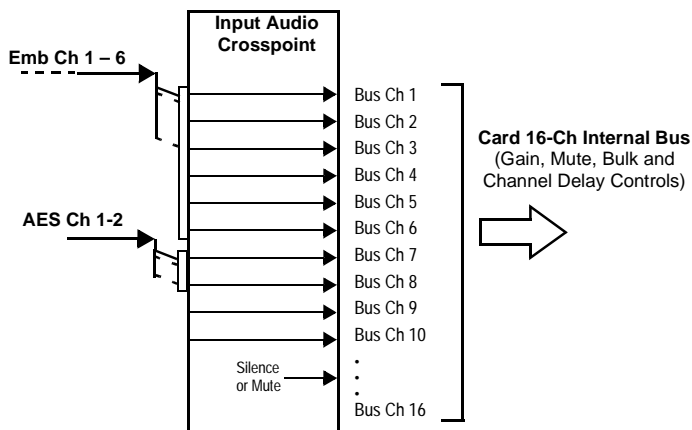
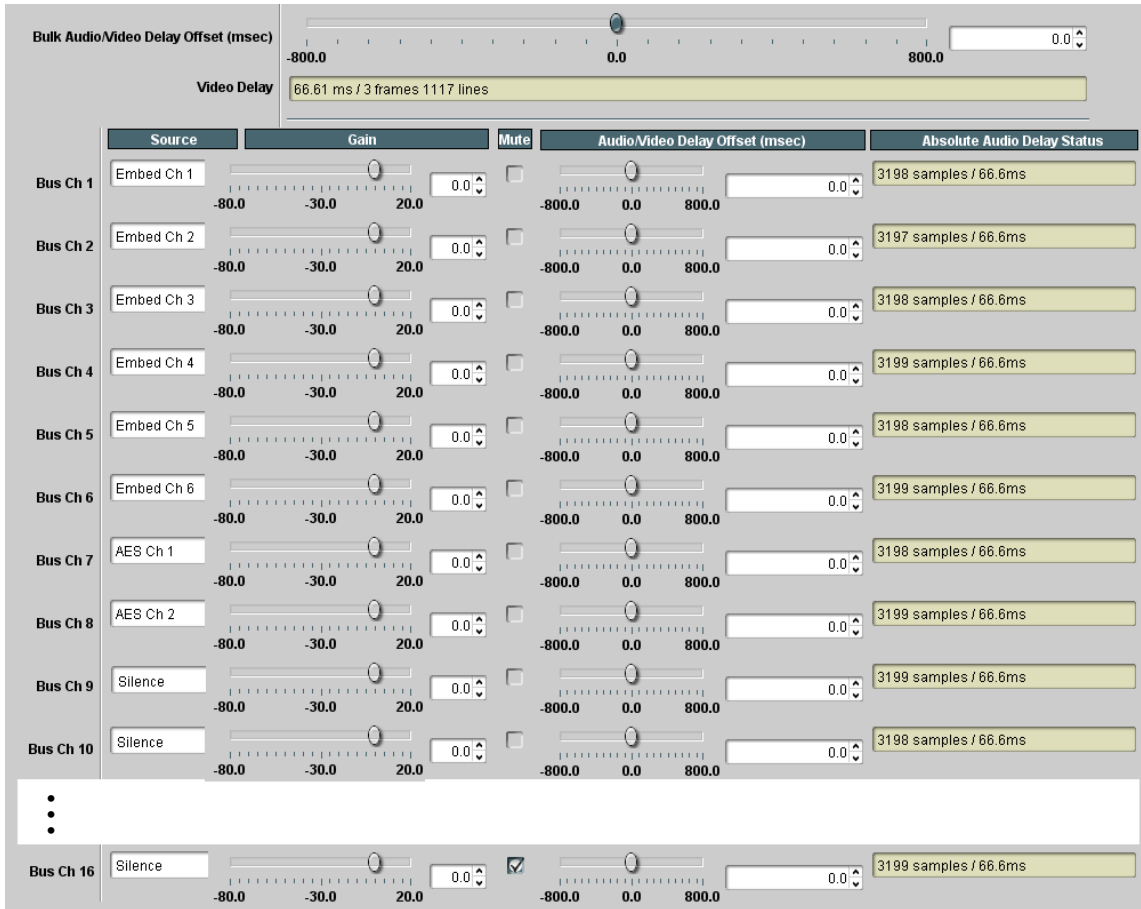

All audio inputs are transferred through the card via the 16-channel Internal Bus (**Bus Ch 1** thru **Bus Ch 16**).

The example above shows various Source selections that direct Emb Ch 1 thru Ch 6 and AES Ch 1 and Ch 2 onto the card internal bus (unused bus channels can be set to Silence or Mute).

Each bus channel provides Gain, Mute, and Audio/Video Delay Offset controls. A Bulk Audio/Video Delay control provides master control of all 16 internal bus channels.

The source-to-destination correlation shown here is only an example; **any** of the sources described on the following pages can route to **any** of the internal bus channels.

Table 3-2 9931-EMDE Function Menu List — continued

<div style="background-color: #444; color: white; padding: 5px; display: inline-block; border-radius: 3px;">Audio Bus Input Routing/Controls</div>		<p>(continued)</p>
<div style="display: flex; justify-content: space-between; border-bottom: 1px solid black; padding-bottom: 5px;"> Input Routing Input Downmixers Input Fle </div>		
<p>Note:</p> <ul style="list-style-type: none"> • Default factory preset routing routes embedded Ch 1 thru Ch 16 to bus channels Bus Ch 1 thru Bus Ch 16. • Bus Ch 2 thru Bus Ch 16 have controls identical to the controls described here for Bus Ch 1. Therefore, only the Bus Ch 1 controls are shown here. • For each bus channel, its source should be considered and appropriately set. Unused bus channels should be set to the Silence selection. 		
<p>• Bus Channel Source</p> 	<p>Using the Source drop-down list, selects the audio input source to be directed to the corresponding bus channel from the choices described below.</p>	
<p>• Embedded Ch 1 thru Ch 16 as Source</p> 	<p>Embed Ch 1 thru Embed Ch 16 range in Source drop-down list routes an embedded channel (Ch 1 thru Ch 16) to be the source for the selected destination bus channel.</p> <p>(In this example, Embed Ch 1 (embedded Ch 1) is the source for destination Bus Ch 1)</p>	
<p>• AES Ch 1 thru AES Ch 16 as Source</p> 	<p>AES Ch 1 thru AES Ch 16 range in Source drop-down list routes an AES channel (Ch 1 thru Ch 16) to be the source for the selected destination bus channel.</p> <p>(In this example, AES Ch 1 is the source for destination Bus Ch 1)</p> <p>Note:</p> <ul style="list-style-type: none"> • AES inputs are only available on card equipped with option +AES (AES audio I/O). • AES port connectors (channel pairs) on the card rear module are set as either Input or Output using the AES Port Direction control on the Output Audio Routing/Controls DashBoard tab. Make certain an AES channel pair is not being used an output before assigning it as a source here. (Refer to Output Audio Routing/Controls (p. 3-42) for more information.) 	
<p>• Analog Ch 1 thru Ch 8 as Source</p>  <p style="background-color: #0070C0; color: white; padding: 2px; display: inline-block; border-radius: 3px; margin-top: 10px;">Option ➔</p>	<p>Analog Ch 1 thru Analog Ch 8 range in Source drop-down list routes an analog channel (Ch 1 thru Ch 8) to be the source for the selected destination bus channel.</p> <p>(In this example, Analog Ch 1 is the source for destination Bus Ch 1)</p> <p>Note:</p> <ul style="list-style-type: none"> • Analog audio inputs are only available on card equipped with option +ANAIO, +ANAVI, or +ANAVO (analog audio I/O). • Analog audio connectors on the card rear module are set as either Input or Output using the AN-AUD I/O (1-8) Mode Switches, located on the 9931 analog audio piggyback PCB. Make certain an analog channel is not being used an output before assigning it as a source here. (Refer to Setting I/O Switches for Analog Audio (1-8) Ports (p. 2-1) for more information.) 	

Table 3-2 9931-EMDE Function Menu List — continued



Audio Bus Input Routing/Controls		
Input Routing	Input Downmixers	Input Flex
<p>• Dolby® Decoded Channel as Source</p>  <p>Option ➤</p>	<p>(continued)</p> <p>Dolby Decoder Out 1 thru Dolby Decoder Downmix R range in Source drop-down list routes a Dolby® decoded channel to be the source for the selected destination bus channel.</p> <p>(In this example, Dolby® decoded Ch 1 is the source for destination Bus Ch 1)</p> <p>Note: Drop-down choices of Ch 1 thru Ch 8 and Mix L / Mix R represent maximum channels available. Actual active channel complement is per received Dolby® format and upstream encoding. Inactive channels should not be used.</p>	
<p>• Downmix A (L/R) thru Downmix D (L/R) as Source</p> 	<p>Downmix A L thru Downmix D R range in Source drop-down list routes a downmixer output channel to be the source for the selected destination bus channel.</p> <p>(In this example, Downmix A L (L output channel of downmixer A) is the source for destination Bus Ch 1)</p> <p>Note: See Input Downmixers sub-tab description in this section for more information.</p>	
<p>• Flex Mix Sum Node A thru P as Source</p> 	<p>Flex Mix A thru Flex Mix P range in Source drop-down list routes 1 of 16 flex mix summing nodes (Flex Mix A thru Flex Mix P) to be the source for the selected destination bus channel.</p> <p>(In this example, Flex Mix A (sum node of flex mixer A) is the source for destination Bus Ch 1)</p> <p>Note: See Input Flex Mix sub-tab description in this section for more information.</p>	
<p>• Gain / Mute Control</p> 	<p>Provides relative gain (in dB) control and a channel Mute checkbox.</p> <p>(-80 to +20 dB range in 0.1 dB steps; unity = 0.0 dB)</p>	

Table 3-2 9931-EMDE Function Menu List — continued

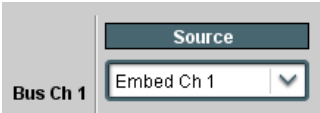
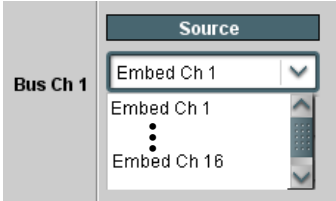
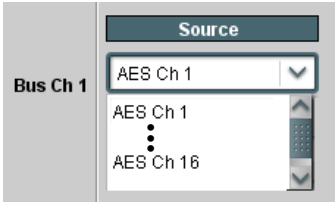
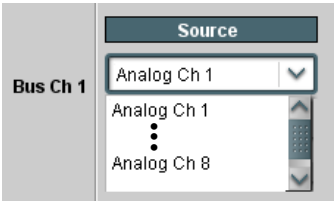
<div style="background-color: #333; color: white; padding: 5px; text-align: center; font-weight: bold;">Audio Bus Input Routing/Controls</div> <div style="display: flex; justify-content: space-around; background-color: #eee; padding: 2px; margin-top: 5px;"> Input Routing Input Downmixers Input Fle </div>	<p>(continued)</p>
<p>• Channel Audio/Video Delay Control/Display</p> 	<p>Offset control adds or reduces (offsets) channel audio delay from the matching video delay (audio delay offset setting adds or removes delay in addition to any delay included by other actions). This control is useful for correcting lip sync problems when video and audio paths in the chain experience differing overall delays.</p> <p>(-800.0 to +800.0 msec range in 0.1 msec steps; null = 0.0 msec)</p> <p>Delay Status shows current delay from video for the corresponding audio channel.</p> <p>Note: Maximum advance/delay offset is dependent on video format. Refer to Technical Specifications (p. 1-26) for details.</p>
<p>• Bulk (Master) Audio/Video Delay Control/Display</p> 	<p>Offset control adds or reduces (offsets) bulk (entire bus) audio delay from the matching video delay (audio delay offset setting adds or removes delay in addition to any delay included by other actions). This control is useful for correcting lip sync problems when video and audio paths in the chain experience differing overall delays.</p> <p>(-800.0 to +800.0 msec range in 0.1 msec steps; null = 0.0 msec)</p> <p>Delay Status shows current delay from video for the audio bus.</p> <p>Note: Maximum advance/delay offset is dependent on video format. Refer to Technical Specifications (p. 1-26) for details.</p>

Table 3-2 9931-EMDE Function Menu List — continued

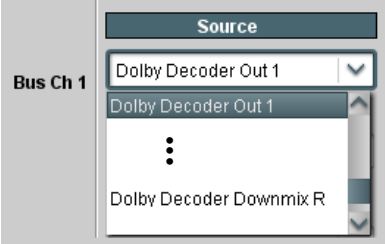
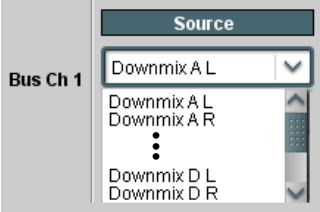
Audio Bus Input Routing/Controls	(continued)
Input Routing Input Downmixers Input Flex	
<ul style="list-style-type: none"> • Auto Audio Failover (Option +AFO) Option 	<p>Provides conditional failover to any alternate (secondary) audio channel received by the card if designated primary channel choice loses signals. Both source (primary channel) and Secondary Source (failover) choices offer from the full complement of source choices described on the previous pages.</p>

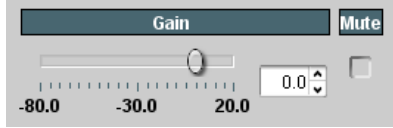
In the example here, bus channels 1 thru 4 have primary sources as Emb Ch 1, Emb Ch 2, AES Ch 1, and AES Ch 2. In the example, AES Ch 1 and AES Ch 2 have experienced signal loss and have failed over to selected choices Analog Ch 1 and Analog Ch 2 (as shown by the **Secondary** Failover indication for these primary channels).

Audio Failover master enable/disable control

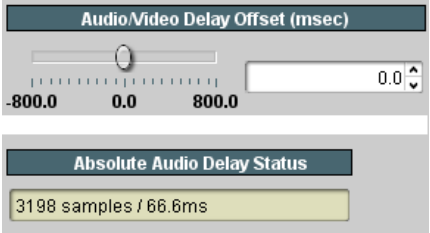
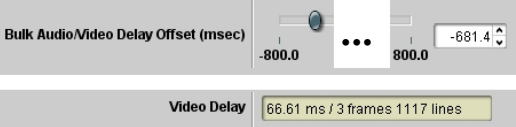
	Source	Secondary Source		Failover
Bus Ch 1	Embed Ch 1	Embed Ch 7	●	Primary
Bus Ch 2	Embed Ch 2	Embed Ch 8	●	Primary
Bus Ch 3	AES Ch 1	Analog Input 1	●	Secondary
Bus Ch 4	AES Ch 2	Analog Input 2	●	Secondary
⋮				
Bus Ch 16	AES Ch 4	Silence	●	Primary

Audio Failover Enabled

Audio Failover Threshold (dBFS)

Primary to Secondary Holdoff (ms)

Secondary to Primary Holdoff (ms)

Failover controls set the conditions that comprise a loss of audio event, and also a transition back to primary channels.

- If the selected channels maintain levels above the selected **Audio Failover Threshold**, no triggering is invoked.
- If these channels fall below the selected threshold for period specified by the **Primary to Secondary Holdoff** control, the primary channels are replaced with the designated secondary channels.
- **Secondary to Primary Holdoff** control sets the time in which the trigger is revoked upon resumption of primary channel signals

Note: Default threshold and holdoff settings shown here are recommended for typical use.

Table 3-2 9931-EMDE Function Menu List — continued

Audio Bus Input Routing/Controls																									
Input Downmixers	Input Flex Mix																								
<p>Input Downmixers – Provides four independent downmixers that each multiplex any five embedded, AES, analog, or Dolby decoder output audio channel sources (as L, R, C, Ls, Rs inputs) into a stereo pair (Downmix A(L) / Downmix A(R) thru Downmix D(L) / Downmix D(R))</p>																									
<p>Note:</p> <ul style="list-style-type: none"> • Downmixers B thru D have controls identical to the controls described here for Downmixer A. Therefore, only the Downmixer A controls are shown here. • For each downmixer input channel, its source should be considered and appropriately set. Unused bus channels should be set to the Silence selection. 																									
<p>• Downmixer A thru D Input Channel Selection</p>	<p>Separate L, R, C, Ls, Rs drop-downs for each of the four independent downmixers (A thru D) that directs any combination of card audio inputs (listed below) to each downmixer input channel.</p> <ul style="list-style-type: none"> • Embed Ch 1 thru Embed Ch 16 • AES Ch 1 thru AES Ch 16 • Analog Ch 1 thru Analog Ch 8 • Dolby Decoder Output Ch 1 thru Dolby Decoder Output Downmix R • Silence 																								
<table border="1" style="width: 100%; border-collapse: collapse; margin-bottom: 10px;"> <tr> <th style="width: 15%;"></th> <th style="width: 15%;">L</th> <th style="width: 15%;">R</th> <th style="width: 15%;">C</th> <th style="width: 15%;">Ls</th> <th style="width: 15%;">Rs</th> </tr> <tr> <td>Downmixer A</td> <td>Embed Ch 1</td> <td>Embed Ch 2</td> <td>Embed Ch 3</td> <td>Embed Ch 5</td> <td>Embed Ch 6</td> </tr> <tr> <td colspan="6" style="text-align: center;">⋮</td> </tr> <tr> <td>Downmixer D</td> <td>Silence</td> <td>Silence</td> <td>Silence</td> <td>Silence</td> <td>Silence</td> </tr> </table>			L	R	C	Ls	Rs	Downmixer A	Embed Ch 1	Embed Ch 2	Embed Ch 3	Embed Ch 5	Embed Ch 6	⋮						Downmixer D	Silence	Silence	Silence	Silence	Silence
	L	R	C	Ls	Rs																				
Downmixer A	Embed Ch 1	Embed Ch 2	Embed Ch 3	Embed Ch 5	Embed Ch 6																				
⋮																									
Downmixer D	Silence	Silence	Silence	Silence	Silence																				
<p>The example here shows selection from various sources and the resulting stereo pair Downmix A(L) and Downmix A(R). The two signals comprising the pair can be routed and processed the same as any other audio input source.</p> <p>Note: The stereo pair consists of basic L/R PCM signals with no additional encoded information.</p>																									
<p>The diagram illustrates the internal routing of Downmixer A. On the left, there are several input channels: 'Embed Ch 1 - Ch 16' (indicated by a dashed line), 'AES Ch 1 - Ch 16', and 'Anlg Ch 1 - Ch 8'. Below these are five 'Embedded Ch' inputs labeled L, R, C, Ls, and Rs, corresponding to channels 1 through 6. These inputs feed into a central processing block. On the right side of this block, two outputs are shown: 'Downmix A(L)' and 'Downmix A(R)'. A bracket on the far right indicates that these two signals are sent 'To Audio Bus Input Routing'.</p>																									

Table 3-2 9931-EMDE Function Menu List — continued

<div style="background-color: #333; color: white; padding: 5px; font-weight: bold;">Audio Bus Input Routing/Controls</div>	
<div style="display: flex; justify-content: space-around; border-bottom: 1px solid black;"> Input Downmixers Input Flex Mix </div>	
<p>• Center Mix Ratio Control</p> 	<p style="text-align: center;">(continued)</p> <p>Adjusts the attenuation ratio of center-channel content from 5-channel source that is re-applied as Lt and Rt content to the DM-L and DM-R stereo mix.</p> <ul style="list-style-type: none"> • Minimum attenuation setting (-0.0 dB) applies no ratiometric reduction. Center channel content is restored as in-phase center-channel content with no attenuation, making center-channel content more predominate in the overall mix. • Maximum attenuation setting (-80.0 dB) applies a -80 dB ratiometric reduction of center-channel content. Center-channel content is restored as in-phase center-channel content at a -80 dB ratio relative to overall level, making center-channel content less predominate in the overall mix. <p>(20.0dB to -80.0 dB range in 0.1 dB steps; default = -3 dB)</p> <p>Note: Default setting is recommended to maintain center-channel predominance in downmix representative to that of the original source 5-channel mix.</p>
<p>• Surround Mix Ratio Control</p> 	<p>Adjusts the attenuation ratio of surround-channel content from 5-channel source that is re-applied as Lo and Ro content to the DM-L and DM-R stereo mix.</p> <ul style="list-style-type: none"> • Minimum attenuation setting (-0.0 dB) applies no ratiometric reduction. Surround-channel content is restored with no attenuation, making Lo and Ro content more predominate in the overall mix. • Maximum attenuation setting (-80.0 dB) applies a -80 dB ratiometric reduction of surround-channel content. Surround-channel content is restored at a -80 dB ratio relative to overall level, making surround-channel content less predominate in the overall mix. <p>(20.0 dB to -80.0 dB range in 0.1 dB steps; default = -3 dB)</p> <p>Note: Default setting is recommended to maintain surround-channel predominance in downmix representative to that of the original source 5-channel mix.</p>

Table 3-2 9931-EMDE Function Menu List — continued

<p>Audio Bus Input Routing/Controls</p> <p>Input Downmixers Input Flex Mix</p>	<p>(continued)</p>
<p>• Auto Downmix (Option +ADM)</p> <p>Option ➔</p> 	<p>Provides an automatic downmix using alternate channels if designated stereo pair lose signals. If content level drops below configurable threshold, primary channel content is replaced with content downmixed from alternate channels.</p> <p>Auto Downmix monitors designated primary channels for up to four downmixers (primary channels Lp and Rp as Emb 1 and Emb 2 in the example).</p> <ul style="list-style-type: none"> • If these channels maintain levels above a selected threshold, primary channels Lp and Rp pass unaffected (as indicated by Failover indicator showing Primary). • If these channels fall below a selected threshold for a specified selected period, downmixed content replaces the primary channels (as indicated by Failover indicator showing Downmix).
	<ul style="list-style-type: none"> • Auto Downmix enables or disables auto downmixing for the four downmixers. • Downmix Threshold sets the threshold (in input dBFS) at which content above the threshold maintains primary channel use. • Primary to Downmix Holdoff sets the time allowed for below-threshold primary content before downmix failover is engaged. • Downmix to Primary Holdoff sets the time allowed, when primary is noted to be above threshold, before primary content is again engaged for use. <p>Note:</p> <ul style="list-style-type: none"> • Default threshold and holdoff settings shown here are recommended for typical use. • For Failover indicator to properly function and for automatic downmix to route to card processing, downmix output channels from this function must be routed to a pair of card internal bus channels. (For example, if primary channels Emb1/Emb2 were to be routed to card internal bus channels Bus1/Bus 2, when using this function, route Downmix A(L) and Downmix A(R) instead to Bus 1/Bus 2.)

Table 3-2 9931-EMDE Function Menu List — continued

Audio Bus Input Routing/Controls

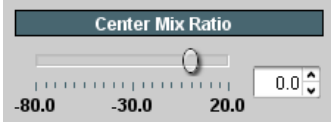
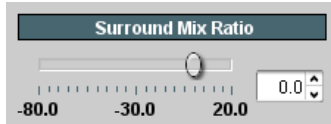
Input Flex Mix – Provides a 16-channel mixer in which each of the inputs can be mixed onto up to 16 independent output summing nodes. Each input channel has independent gain and mute controls.

Source	Flex Mix Bus	
Flex Mix 1	Embed Ch 1	Flex Mix A
Flex Mix 2	Embed Ch 2	Flex Mix A
Flex Mix 3	Embed Ch 3	Flex Mix A
Flex Mix 4	Embed Ch 4	Flex Mix A
Flex Mix 5	Embed Ch 5	Flex Mix B
Flex Mix 6	Embed Ch 6	Flex Mix B
Flex Mix 7	Embed Ch 11	Flex Mix B
Flex Mix 8	Embed Ch 12	Flex Mix B
Flex Mix 9	Embed Ch 13	Flex Mix C
Flex Mix 10	Embed Ch 14	Flex Mix C
Flex Mix 11	Embed Ch 15	Flex Mix C
Flex Mix 12	Embed Ch 16	Flex Mix C
Flex Mix 13	Analog Input 1	Flex Mix D
Flex Mix 14	Analog Input 2	Flex Mix D
Flex Mix 15	Analog Input 3	Flex Mix D
Flex Mix 16	Analog Input 4	Flex Mix D

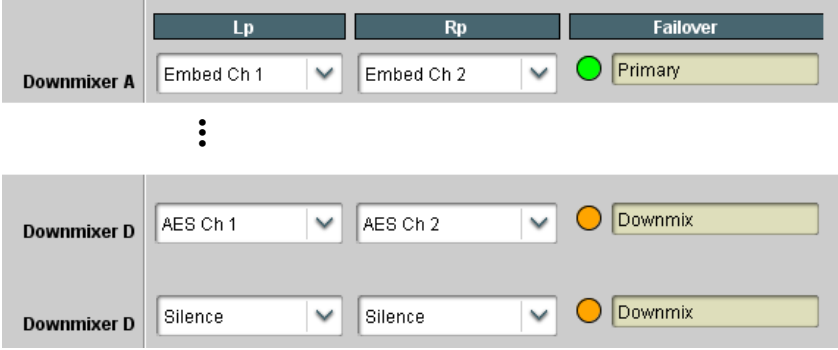
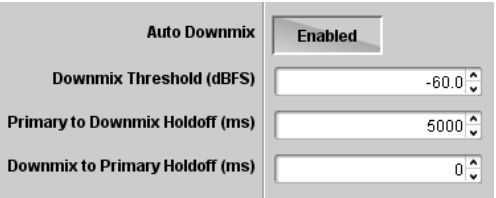
In this example four, 4-input mono mixers are provided by selecting **Flex Mixer Bus A** for the Flex Mix 1 thru Flex Mix 4 inputs, and **Flex Mixer Bus B** for the next four inputs, and so on as shown.

Source	Flex Mix Bus	
Flex Mix 1	Embed Ch 1	Flex Mix A
Flex Mix 2	Embed Ch 2	Flex Mix A
Flex Mix 3	AES Ch 1	Flex Mix B
Flex Mix 4	AES Ch 2	Flex Mix B
Flex Mix 5	Analog Input 5	Flex Mix C
Flex Mix 6	Analog Input 6	Flex Mix C
Flex Mix 7	Silence	Flex Mix D
...		
Flex Mix 16	Silence	Flex Mix D

In this example three, 2-input mono mixers are provided by selecting **Flex Mixer Bus A** for the Flex Mix 1 and Flex Mix 2 inputs, and **Flex Mixer Bus B** for the next two inputs, and so on as shown.

3-40

9931-EMDE PRODUCT MANUAL

9931-EMDE-OM (V1.18)

Table 3-2 9931-EMDE Function Menu List — continued

<div style="background-color: #333; color: white; padding: 5px; border: 1px solid black;"> Audio Bus Input Routing/Controls </div>		<p>(continued)</p>
<div style="background-color: #ccc; padding: 2px; border: 1px solid black; display: flex; justify-content: space-between;"> Routing Input Downmixers Input Flex Mix </div>		
<p>Note:</p> <ul style="list-style-type: none"> Flex Mix input channels Flex Mix 2 thru Flex Mix 16 have controls identical to that described here for Flex Mix 1. Therefore, only the Flex Mix 1 controls are shown here. For each Flex Mix input channel, its source should be considered and appropriately set. Unused input channels should be set to the Silence selection. 		
<p>• Flex Mix Input Channel Source</p> 	<p>Using the Source drop-down list, selects the audio input source to be directed to the corresponding bus channel from the choices listed below.</p> <ul style="list-style-type: none"> • Silence • Embed Ch 1 thru Embed Ch 16 • AES Ch 1 thru AES Ch 16 • Analog Ch 1 thru Analog Ch 8 • Dolby Decoder Output Ch 1 thru Dolby Decoder Output Downmix R 	
<p>• Gain / Mute Control</p> 	<p>Provides relative gain (in dB) control and a channel Mute checkbox.</p> <p>(-80 to +20 dB range in 0.1 dB steps; unity = 0.0 dB)</p>	
<p>• Flex Mix Summing Node (Bus) Selector</p> 	<p>Each Flex Mix input channel can be fed as desired to any of 16 summing node buses (Flex Mix A thru Flex Mix P). The flex mix buses can be routed and processed the same as any other audio input source.</p> <p>Note: See the examples on the previous page for providing various types of mixers by applying a common Flex Mix Bus to various input channels.</p>	
<div style="background-color: #333; color: white; padding: 5px; border: 1px solid black;"> Audio Bus Input Routing/Controls </div>		
<div style="background-color: #ccc; padding: 2px; border: 1px solid black; display: flex; justify-content: space-between;"> Mixers Input Flex Mix Dolby E Alignment </div>		
<p>• Dolby E Embedding Alignment Control</p> 	<p>For incoming Dolby E data routed to the card audio bus (either over embedded channels or via AES embedding to the bus), aligns the embedded Dolby data corresponding to selection. Alignment line as a result of selection is shown in Status display.</p> <p>Note:</p> <ul style="list-style-type: none"> Where a frame reference is available, it is recommended to use the Align to Reference selection. This helps ensure that the correct alignment is achieved even if the video is user delayed or output format (scaling) is changed. <p>Refer to “Preferred Alignment for Dolby E in HD Systems” (http://www.dolby.com/about/news-events/newsletters-dtvaudio-dolby-e-alignment.html) for more information regarding Dolby E alignment. This control applies only to externally received Dolby E data streams. Card Dolby E encoder (if used) data is automatically aligned with video to utilize guard band. </p>	

Table 3-2 9931-EMDE Function Menu List — continued

<h3>Output Audio Routing/Controls</h3> <div style="display: flex; justify-content: space-around; border: 1px solid black; padding: 2px;"> Emb Audio Out AES Audio Out </div>	<p>Provides controls to route card audio from card processing paths to outgoing embedded and AES audio destinations. Use the corresponding sub-tab to access embedded or AES output routing.</p>
--------------------------------------------------------------------------------------------------------------------------------------------------------------------------------------------------------	--------------------------------------------------------------------------------------------------------------------------------------------------------------------------------------------------

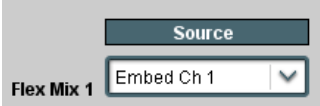
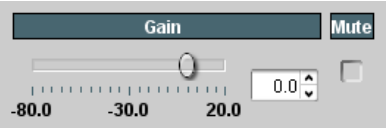
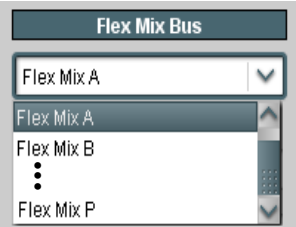
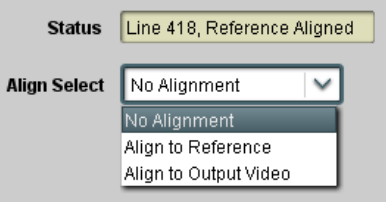
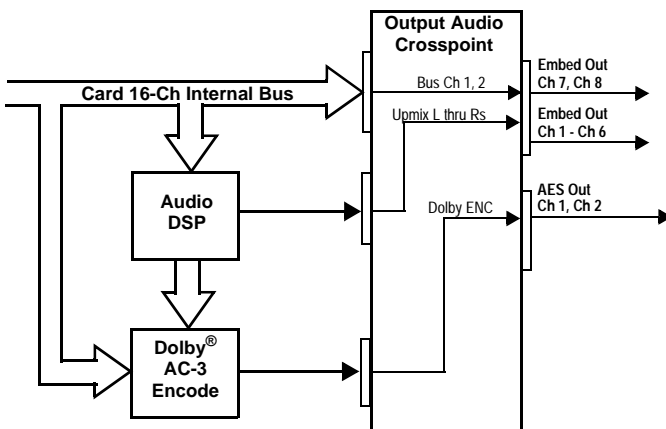
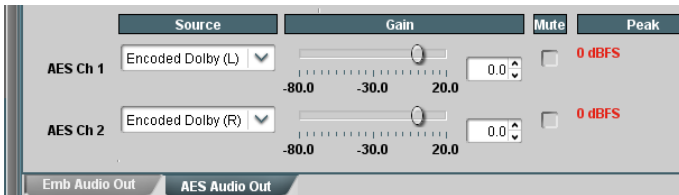

The card internal bus, Audio DSP outputs, and the Dolby encoder output pair are available as sources for the card embedded audio and AES audio outputs.

The example here shows various Source routing selections (using the **Emb Audio Out** and **AES Audio Out** sub-tabs) that direct upmix outputs L thru Rs to Embedded outputs Ch 1 thru Ch 6, the pre-upmix Bus Ch1 and Ch 2 sources to Embedded outputs Ch 7 and Ch 8, and a Dolby encoded pair to AES outputs Ch 1 and Ch 2 (unused embedded and AES channels can be set to Silence or Mute).

Each bus channel provides Gain, Mute, and a peak level display.

The source-to-destination correlation shown here is only an example; **any** of the digital audio output destinations described on the following pages can receive inputs from **any** of the internal bus, DSP, or Dolby encoder sources.

Table 3-2 9931-EMDE Function Menu List — continued

<div style="background-color: #333; color: white; padding: 5px; text-align: center; font-weight: bold;">Output Audio Routing/Controls</div> <hr/> <div style="display: flex; justify-content: space-around; border: 1px solid gray; padding: 2px;"> Emb Audio Out AES Audio Out </div>	<p>(continued)</p>
<p>Note: Default factory preset routing routes bus channels Bus Ch 1 thru Bus Ch 16 to embedded outputs Emb Ch 1 thru Emb Ch 16.</p>	
<p>• Embedded Output Channel Source Select</p> 	<p>With the Emb Audio Out sub-tab selected, using the Source drop-down list selects the card audio source to be directed to the corresponding embedded output channel from the choices described below.</p>
<p>• Bus Ch 1 thru Ch 16 as Source for Embedded Channel Output</p> 	<p>Bus Ch 1 thru Bus Ch 16 range in Source drop-down list routes a card internal bus channel (Bus Ch 1 thru Bus Ch 16) to be the source for the selected embedded output channel.</p> <p>(In this example, Bus Ch 1 is the source for destination Embedded output Ch 1)</p>
<p>• Upmixer Channels as Source for Embedded Channel Output</p> 	<p>Upmix L thru Upmix Rs range in Source drop-down list routes an upmixed channel to be the source for the selected embedded output channel.</p> <p>(In this example, Upmix L is the source for destination Embedded output Ch 1)</p>
<p>• Loudness-Processed Channels as Source for Embedded Channel Output</p> 	<p>LP51 L thru LP51 Rs (5.1-channel loudness processor processed channels L thru Rs) range in Source drop-down list routes a loudness-processed channel to be the source for the selected embedded output channel.</p> <p>(In this example, loudness-processed channel LP51 L is the source for destination Embedded output Ch 1)</p> <p>Note: Where stereo loudness processor is available, drop-down selections for these channels are LP2 L and LP2 R.</p>
<p>• Tone as Source for Embedded Channel Output</p> 	<p>Tone 50 Hz thru Tone 16 kHz range in Source drop-down list routes one of eight tone frequencies to be the source for the selected embedded output channel.</p> <p>(In this example, 50 Hz tone is the source for destination Embedded output Ch 1)</p>

Table 3-2 9931-EMDE Function Menu List — continued



<p style="text-align: center;">Output Audio Routing/Controls</p> <p style="text-align: center;">Emb Audio Out AES Audio Out</p>	<p style="text-align: center;">(continued)</p>
<p>• Dolby® Encoder Output as Source for Embedded Channel Output</p> 	<p>Encoded Dolby (L) and Encoded Dolby (R) selection in Source drop-down list routes a Dolby encoded pair from any of the card's Dolby encoders (A up to D) to be the source for the selected embedded output channel.</p> <p>(In this example, Dolby Digital Encoder B (L) is the source for destination Embedded output Ch 1)</p> <p>Note: Encoded channel pairs selected should only be applied to companion intact pairs (e.g., signals can be applied to embedded pair 1/2, or embedded pair 3/4 and so on, but not split to route through fabricated unrelated pairs such as embedded ch 2/ch 3).</p>
<p>• Silence as Source for Embedded Channel Output</p> 	<p>Silence selection in Source drop-down list mutes the selected embedded output channel. Use this setting for any unused embedded output channels.</p> <p>(In this example, Silence is the source for destination Embedded output Ch 1)</p>
<p>• Gain / Mute Control</p> 	<p>Provides relative gain (in dB) control and peak level display for corresponding embedded output channel.</p> <p>Also provides a channel Mute checkbox.</p> <p>(-80 to +20 dB range in 0.1 dB steps; unity = 0.0 dB)</p>
<p>• Group Enable/Disable Controls</p> 	<p>Allows enable/disable of embedded audio groups 1 thru 4 on card program video output to accommodate some legacy downstream systems that may not support all four embedded audio groups.</p> <p>Note: Changing the setting of this control will result in a noise burst in group adjacent to that being enabled or disabled. This control should not be manipulated when carrying on-air content.</p>

Table 3-2 9931-EMDE Function Menu List — continued

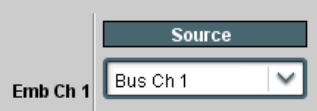
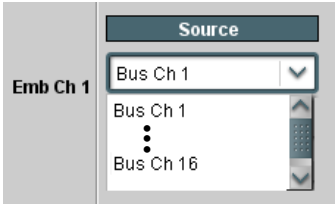
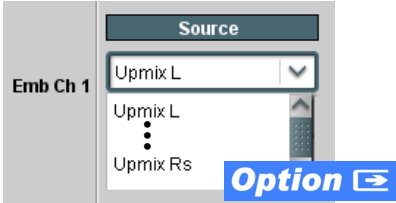
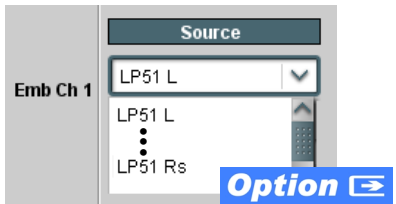
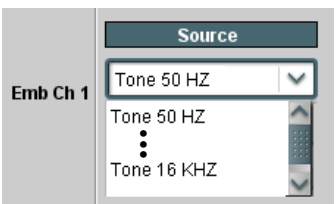

	<p>(continued)</p>
<p>• AES Port Direction Select</p> 	<p>Provides port direction control for each AES port on the card rear module.</p> <p>Note:</p> <ul style="list-style-type: none"> • AES port direction selector controls input or output direction on a channel pair basis. • When using the AES Port Direction controls for an AES pair, only the even-channel control of the pair responds to DashBoard control. (For example, to change AES pair 1 from input to output, click on the AES Ch 2 AES Output direction radio button.) • Before assigning a pair as a output here, make certain an AES channel pair is not being used as an input. <ul style="list-style-type: none"> - If a port is to be used as an output, set control for desired pair to AES Output. - If a port is to be used as an input, set control for desired pair to AES Input. Refer to Audio Bus Input Routing/Controls (p. 3-32) to route an AES input into the card.
<p>Note:  Cards with option +AES16 do not share AES input and output BNC ports. 16 channels of AES input embedding is available using the Audio Bus Input Routing/Controls, with 16 channels of AES output de-embedding using the AES Ch1 thru AES Ch 16 AES outputs on the AES Audio Out sub-tab. This option is fully utilized only when using rear I/O module RM20-9931-G.</p>	
<p>• AES Output Channel Source Select</p> 	<p>With the AES Audio Out sub-tab selected, using the Source drop-down list selects the card audio source to be directed to the corresponding AES output channel from the choices described below.</p>
<p>• Bus Ch 1 thru Ch 16 as Source for AES Channel Output</p> 	<p>Bus Ch 1 thru Bus Ch 16 range in Source drop-down list routes a card internal bus channel (Bus Ch 1 thru Bus Ch 16) to be the source for the selected AES output channel.</p> <p>(In this example, Bus Ch 1 is the source for destination AES output Ch 1)</p>
<p>• Upmixer Channels as Source for AES Channel Output</p> 	<p>Upmix L thru Upmix Rs range in Source drop-down list routes an upmixed channel to be the source for the selected AES output channel.</p> <p>(In this example, Upmix L is the source for destination AES output Ch 1)</p>

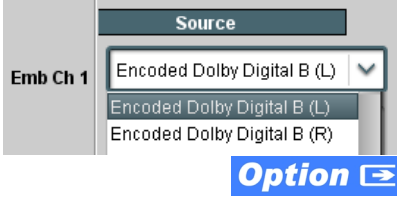
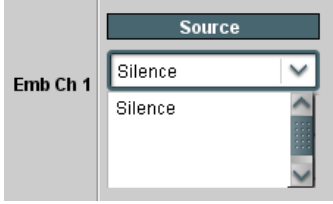
Table 3-2 9931-EMDE Function Menu List — continued

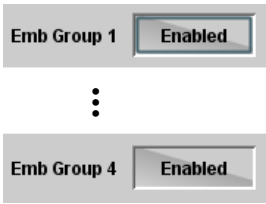
Output Audio Routing/Controls	
Emb Audio Out AES Audio Out	
<p>• Loudness-Processed Channels as Source for AES Channel Output</p> 	<p>(continued)</p> <p>LP51 L thru LP51 Rs (5.1-channel loudness processor processed channels L thru Rs) range in Source drop-down list routes a loudness-processed channel to be the source for the selected AES output channel.</p> <p>(In this example, loudness-processed channel LP51 L is the source for destination AES output Ch 1)</p> <p>Note: Where stereo loudness processor is available, drop-down selections for these channels are LP2 L and LP2 R.</p>
<p>• Tone as Source for AES Channel Output</p> 	<p>Tone 50 Hz thru Tone 16 kHz range in Source drop-down list routes one of eight tone frequencies to be the source for the selected embedded output channel.</p> <p>(In this example, 50 Hz tone is the source for destination AES output Ch 1)</p>
<p>• Dolby® Encoder Output as Source for AES Channel Output</p> 	<p>Encoded Dolby (L) and Encoded Dolby (R) selection in Source drop-down list routes a Dolby encoded pair from any of the card's Dolby encoders (A up to D) to be the source for the selected AES output channel.</p> <p>(In this example, Dolby Digital Encoder B (L) is the source for destination AES output Ch 1)</p> <p>Note: Encoded channel pairs selected should only be applied to companion intact pairs (e.g., signals can be applied to AES pair 1/2, or AES pair 3/4 and so on, but not split to route through fabricated unrelated pairs such as AES ch 2/ch 3).</p>
<p>• Silence as Source for AES Channel Output</p> 	<p>Silence selection in Source drop-down list mutes the selected AES output channel. Use this setting for any unused AES output channels.</p> <p>(In this example, Silence is the source for destination Embedded output Ch 1)</p> <p>Note: If an AES pair is being used as an input, the channels do not have to be muted here.</p>
<p>• Gain / Mute Control</p> 	<p>Provides relative gain (in dB) control and peak level display for corresponding AES output channel.</p> <p>Also provides a channel Mute checkbox.</p> <p>(-80 to +20 dB range in 0.1 dB steps; unity = 0.0 dB)</p>

Table 3-2 9931-EMDE Function Menu List — continued

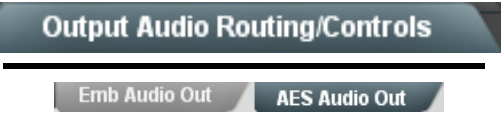
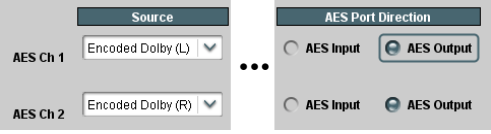
	<p>Provides upmixing of any normal PCM stereo pair into 5.1 surround sound audio which in turn can be applied to six user-selectable channels. (Option +UM)</p>
<p>Note:</p> <ul style="list-style-type: none"> For any six channels selected for this function, the Left and Right channel selections always serve as the stereo input pair. Upmixing induces a 6 msec delay into the audio. This delay can be removed by setting either the bulk or channel Audio/Video Delay controls to introduce a -6 msec advance. See Audio Bus Input Routing/Controls (p. 3-32). 	
<p>Up Mixer Mode Control</p> 	<p>Enables or bypasses upmixer as follows:</p> <ul style="list-style-type: none"> Auto: Automatic enable/bypass of 5.1 upmix function as follows: <ul style="list-style-type: none"> If detected signal level on all three of the selected channels designated as Center, Left Surround, and Right Surround are below the level threshold set using the 5.1 Detection Threshold control (described below), upmixer produces new 5.1 content generated by the upmixer. If detected signal level on any of the three of the selected channels designated as Center, Left Surround, and Right Surround is above the level threshold set using the 5.1 Detection Threshold control, upmixing is bypassed and the channels fed to the upmixer pass unaffected to the upmixer outputs. Always Upmix: Manual enable turns on upmixer and overwrites content on all six selected channels with new 5.1 content generated by the upmixer regardless of original signal level or content. Bypass: Manual disable bypasses the upmixer. When bypassed, the six input audio channels pass unaffected to the upmixer output.
<p>Upmixer Input Channel Selection</p>  <p>Selects the audio input source to be directed to the corresponding upmixer input from the choices listed below.</p> <ul style="list-style-type: none"> Bus Ch 1 thru Bus Ch 16 LP L thru LP Rs (multiple if equipped with multiple loudness processing) Tone 1 thru Tone 8 Silence 	<p>Separate drop-down lists for Left, Right, Center, LFE, Left Surround, and Right Surround allow a stereo pair to be upmixed to 5.1-channel.</p>  <p>The example here shows selection of bus channels 1 and 2 as the received stereo source (Bus Ch1 and Ch 2 for Left and Right drop-down list selections in the Upmixer Selection tool).</p> <p>Using the setup shown in the example, when upmix is active (either forced upmix or auto-enabled) the Upmix L thru Upmix Rs channels comprise a 5.1-channel upmix of the input stereo pair. If any content is present on the monitored C, LFE, Ls, or Rs input channels whose is above a user-defined level threshold (Bus Ch 3 thru Ch 6 in this example), all six inputs channels pass through the upmixer, with upmixing bypassed.</p> <p>Upmixer output channels Upmix L thru Upmix Rs are available as sources for the card audio output routing.</p> 

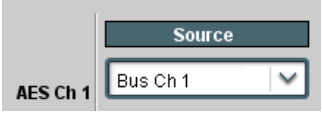
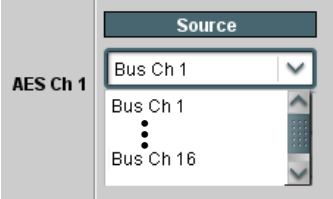
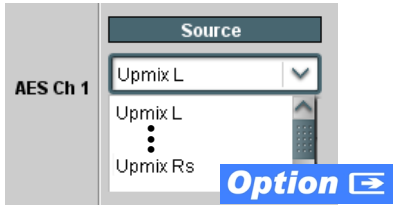
Table 3-2 9931-EMDE Function Menu List — continued

<p style="text-align: center;">Upmixing</p>	<p style="text-align: center;">(continued)</p>
<p>• Up Mixer Status Display</p> <div style="margin-bottom: 10px;"> <p>Status Auto Mode - Currently Upmixing</p> </div> <div style="margin-bottom: 10px;"> <p>Status Auto Mode - Currently Bypassed</p> </div> <div style="margin-bottom: 10px;"> <p>Status Upmixing</p> </div> <div> <p>Status Bypassed</p> </div>	<p>Shows activity status of upmixer processing as follows:</p> <ul style="list-style-type: none"> • Auto Mode - Currently Upmixing: With upmixer enable set to Auto, indicates selected channels designated as Center, LFE, Left Surround, and Right Surround are clear for use (as described above); upmixer is currently up-mixing received stereo pair and overwriting the six selected channels with new 5.1 upmix. • Auto Mode - Currently Bypassed: With upmixer enable set to Auto, indicates selected channels designated as Center, LFE, Left Surround, and Right Surround have content (such as existing original 5.1 or other content); upmixer is bypassed (disabled) and allows normal passage of six selected channels. • Upmixing: Indicates upmixer is manually enabled (set to Always Upmix) and is currently up-mixing received stereo pair and overwriting the six selected channels with new 5.1 upmix. • Bypassed: Indicates upmixer is manually disabled (set to Bypass) and is currently passing all selected channels unaffected.
<p>• Auto Crossfade Speed Controls</p> <div style="margin-bottom: 10px;"> <p>Auto Crossfade Speed Upmix to Bypass</p> <div style="border: 1px solid gray; padding: 2px;"> <p>Very Slow (2000 ms) ▾</p> <p>Very Slow (2000 ms)</p> <p>Slow (1000 ms)</p> <p>Medium (500 ms)</p> <p>Quick (250 ms)</p> <p>Very Quick (100 ms)</p> <p>Instant (10 ms)</p> </div> </div> <div> <p>Auto Crossfade Speed Bypass to Upmix</p> <div style="border: 1px solid gray; padding: 2px;"> <p>Very Slow (2000 ms) ▾</p> <p>Very Slow (2000 ms)</p> <p>Slow (1000 ms)</p> <p>Medium (500 ms)</p> <p>Quick (250 ms)</p> <p>Very Quick (100 ms)</p> <p>Instant (10 ms)</p> </div> </div>	<p>Individual controls select the relative crossfade transition speed between Upmix to Bypass (going to inactive; from 5.1 to 2.0) and Bypass to Upmix (going to active; from 2.0 to 5.1) when upmixer enable is set to Auto and the active threshold (as set by the 5.1 Detection Threshold control) is crossed in either direction.</p> <p>To suit program material and production aesthetic preferences, several choices are available as shown to the left. Slower settings allow for a more gradual transition between modes, however with a longer interval before levels stabilize. Faster settings conversely allow for a smaller interval before levels stabilize, however with greater perceived abruptness.</p>

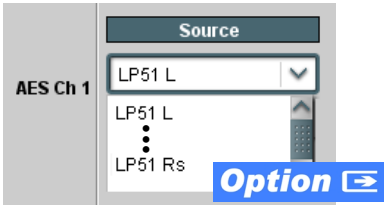
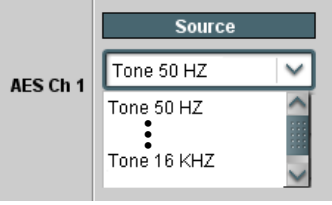
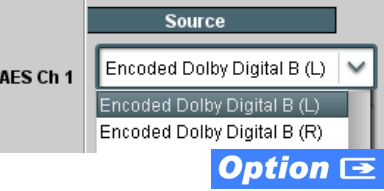
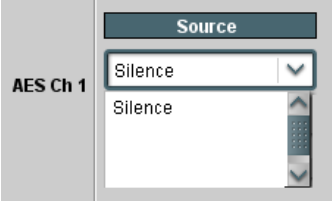
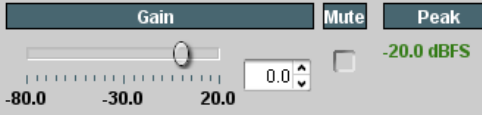
Table 3-2 9931-EMDE Function Menu List — continued

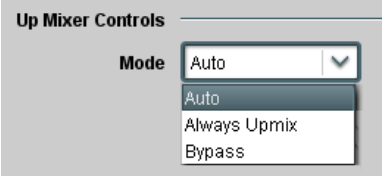
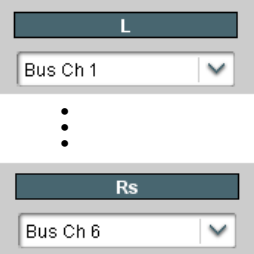
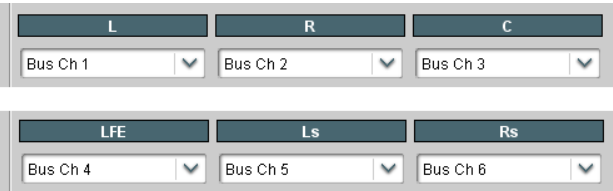
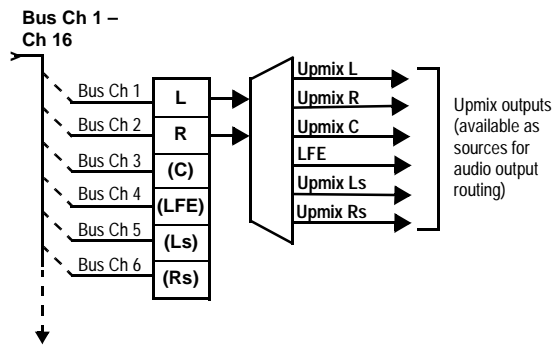

<p style="text-align: center; background-color: #333; color: white; padding: 5px;">Upmixing</p>	<p style="text-align: center;">(continued)</p>
<p>• 5.1 Detection Threshold Control</p> 	<p>Adjusts the threshold at which selected channels designated as C, LFE, Ls, and Rs are considered to have viable content, or at which signal levels can be considered insignificant when upmixer enable is set to Auto. Setting affects automatic enable/bypass of 5.1 upmix function as follows:</p> <ul style="list-style-type: none"> • If detected signal level on all three of the selected channels designated as Center, Left Surround, and Right Surround are below the level threshold set using the 5.1 Detection Threshold control, upmixer allows overwrite of all six selected channels with the new 5.1 signal complement. • If detected signal level on any of the three of the selected channels designated as Center, Left Surround, and Right Surround is above the level threshold set using the 5.1 Detection Threshold control, upmixer is bypassed, thereby releasing the selected six channels and allowing the original channels to pass unaffected. <p>(Range is -150 dB to 0 dB in 0.1dB steps; 0 dB equivalent to +24 dBu=> 0 dBFS)</p> <hr/> <p>Typically, the 5.1 Detection Threshold control should be set to provide a usable threshold that maintains a threshold at which valid levels large enough over the threshold disable the auto upmix (A, left), while nuisance levels considerably below the threshold (B, left) are rejected, allowing the upmixer to stay locked in the enabled mode and overwrite these signals with the new signals.</p>  <p>Optimum setting is dependent on program material general overall levels. A -60 dB setting is recommended for material closely adhering to the SMPTE -20 dBFS Alignment level for normal material such as dialog.</p>
<p>• Center Width Control</p> 	<p>Adjusts center channel content (in terms of percentage) applied to L and R channels.</p> <ul style="list-style-type: none"> • Minimum setting keeps all L+R (mono) content confined to center (C) channel, with any center channel content removed from L and R channels. • Higher settings progressively blend respective L and R mono content back into L and R channels, with 100% setting resulting in center channel level going to zero and L/R channels becoming normal L/R channels containing some mono content. <p>(0% to 100% range in 0.1% steps; default = 0%)</p>
<p>• Surround Depth Control</p> 	<p>Adjusts surround channel content (in terms of percentage) applied to Ls and Rs channels.</p> <ul style="list-style-type: none"> • Maximum setting results in greatest surround channel levels. • Lower settings progressively diminish surround channel levels, with 0% setting resulting in no Ls or Rs level, with Ls and Rs content progressively folded back into L and R, respectively. <p>(0% to 100% range in 0.1% steps; default = 100%)</p>

Table 3-2 9931-EMDE Function Menu List — continued

<p>COM and Metadata Routing</p>	<p>Provides input and output support of Dolby metadata routing between optional Dolby encoder/decoder and serial/video interfaces.</p>
<p>Note:</p> <ul style="list-style-type: none"> • “Dolby Decoder” drop-down choices and “Dolby Encoder” selector for this function appear only on cards equipped with a Dolby decoder and/or Dolby encoder. • After familiarizing yourself with the controls described here, see the following page for an example showing interrelated use of these controls. 	
<p>Serial Port Selectors</p> <p>Serial Port Controls</p> <p>COM 1 <input type="text" value="Out - Dolby decoder"/></p> <p>COM 2 <input type="text" value="Input"/></p> <p>Serial Port Conflicts <input type="text" value=""/></p>	<p>For serial ports 1 and 2, selects the source for metadata to be exported (outputted) from the card over a port as shown from the choices listed to the left and shown below. (None selection frees the port to be used as an input.)</p>  <p>Note: If settings here and described below attempt to set a given port as both an output and an input, Serial Ports Conflict status display indicates conflict (e.g., “Port 1 configured as both input and output”.)</p>
<p>VBI SMPTE 2020 Embedding Source Selector</p> <p>SMPTE 2020 Embedder Controls</p> <p>Metadata Source <input type="text" value="Serial port 1"/></p>	<p>For VBI embedding at the card SDI output, selects the source of metadata to be exported (outputted) from the card from the choices listed to the left and shown below.</p> 
<p>SDI Input VBI Metadata Status Display</p> <p>Input Status <input type="text" value="Receiving embedded metadata on line 13"/></p>	<p>Indicates if Dolby metadata is present on input SDI VBI, as well as VBI line number. (If no metadata present, displays “Not Present”.)</p>

Table 3-2 9931-EMDE Function Menu List — continued

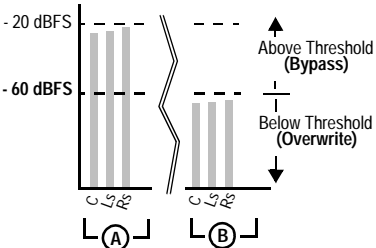
COM and Metadata Routing	(continued)
<p>• Metadata Embedding</p> <div style="border: 1px solid #ccc; padding: 5px; margin-bottom: 10px;"> <p>Embedded Metadata Output <input type="checkbox"/> On</p> <p>Embedded Output Line <input type="text" value="13"/> ▼</p> </div>	<p>Embedded Metadata Output enables SMPTE 2020-1 metadata embedding in the SDI video output, as selected using controls described above.</p> <p>Embedded Output Line allows selection of SMPTE 2020-1 metadata line location within the VANC space for re-inserted Dolby® metadata.</p> <p>(Range is 9 thru 41)</p> <p>Note:</p> <ul style="list-style-type: none"> Although the output line drop-down will allow any choice within the 9 thru 41 range, the actual range is automatically clamped (limited to) certain ranges to prevent inadvertent conflict with active picture area depending on video format. See Ancillary Data Line Number Locations and Ranges (p. 3-9) for more information. The card does not check for conflicts on a given line number. Make certain the selected line is available and carrying no other data unless existing metadata is to be intentionally overwritten. <p>Typically, when encoding is active it is recommended that any metadata not specifically related to that being used by the encoder be removed (or replaced with metadata being used by the encoder), and also that the line number be set to overwrite obsolete input VBI metadata. Also, the encoded pair carries the up to date metadata within the encoded pair stream. Removing or replacing obsolete metadata avoids any ambiguity of having different metadata packets on multiple lines, or metadata that is not related to the encoding being performed.</p>

Metadata Routing Example

In this example, the on-card Dolby encoder is to receive external metadata over serial port B. Also, the new metadata from the on-card decoder is to be inserted into the SDI output SMPTE 2020 VBI and exported from the card over serial port A.

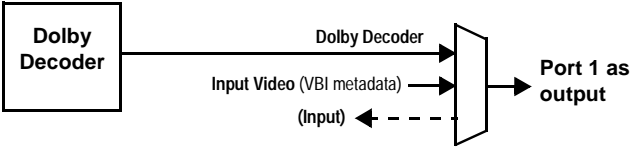
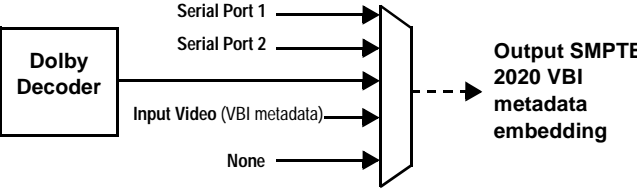
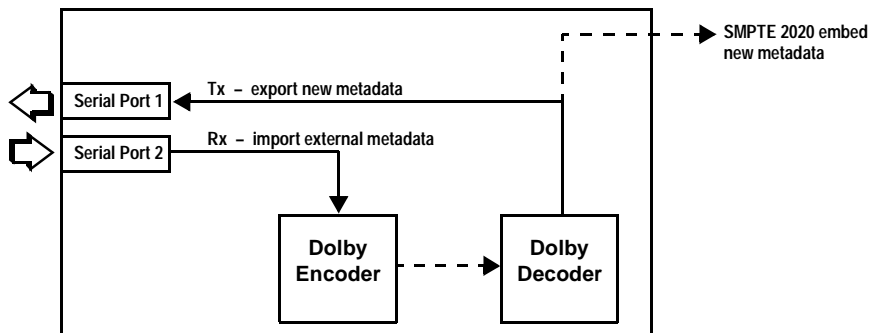
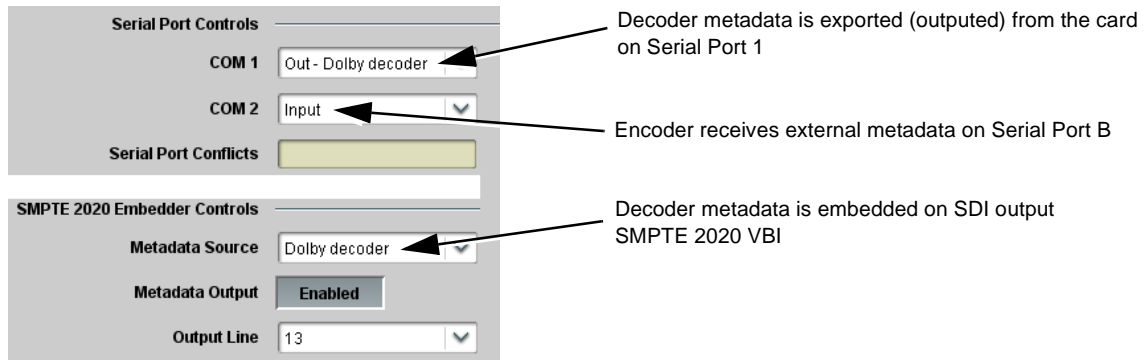

Table 3-2 9931-EMDE Function Menu List — continued



	<p>Provides two independent GPI controls for GPI 1 and GPI 2 that invoke a user-defined card presets upon receiving a contact closure/logic level on the corresponding GPI input.</p> <p>Also provides two independent contact pairs (GPO 1 and GPO 2) that can be invoked by setting a GPO to be enabled when a card preset is in turn applied.</p>
<p>Note: After familiarizing yourself with the GPI controls described here, see “Audio Routing with GPI Control Example” (p. 3-58) for a comprehensive example using these controls for multi-source audio routing.</p>	
<p>• GPI Status Displays</p> 	<p>Status displays for GPI 1 and GPI 2 indicate Open (and “unlit” indicator) for GPI not present on GPI input. Display indicates Closed (and “lit” indicator) when GPI is present.</p> <p>Note: GPI trigger threshold/type is set using GPI Coding drop-down described below. Refer to Specifications in Introduction, Chapter 1 for GPI electrical specifications and limitations.</p>
<p>• GPI Preset Number Go-To Select</p> 	<p>Individual drop-downs (one for each of the four GPI states monitored by the card) allow invoking a card preset when the corresponding GPI state is true.</p> <ul style="list-style-type: none"> • No Preset setting inhibits going to a preset if the state corresponding to the drop-down becomes true. This setting is typically used to inhibit GPI for an unused GPI. • 1 thru 64 setting allows any of 64 user-defined presets to be invoked when the state corresponding to the drop-down becomes true. <p>Note:</p> <ul style="list-style-type: none"> • No Preset setting should be considered and used for any logic state that is not specifically to be used for a valid GPI state. • GPI go-to number settings are independent of saved presets and cannot be defined under a preset. • Make certain presets toggled by GPI call identical card settings except for what is expressly to be changed by the toggle. In addition to invoking undesired operation, unintentionally different settings called in presets may invoke states that result in longer engagement times (e.g., even if a Dolby® encoder is not used on either toggled GPI preset invocation, undesired setup such as enabling an encoder from disabled to enabled may cause longer engagement time overall. Make sure such functions are similarly set for both preset toggles whenever possible unless required).
<p>• GPO Enable</p> 	<p>Enables GPO 1 and/or GPO 2.</p> <p>GPO is designed to be used in association with a card preset. If GPO is set to be closed, and this setting is saved along with other items to a particular preset, whenever the preset is invoked the GPO will also be invoked.</p> <p>Example: Assume GPO 1 is set Closed, with this setting saved with others in Preset 6. With Preset 6 invoked, GPO 1 will now go to closed.</p> <p>If Preset 6, using Event Based Loading, is set to be invoked whenever SD is received, in turn whenever SD is received GPO 1 will also be invoked. As such in this example, GPO 1 would serve as a GPO that indicates when SD is being received.</p>

Table 3-2 9931-EMDE Function Menu List — continued

GPIO Controls	(continued)										
<p>• GPI Trigger Coding</p> <div style="border: 1px solid #ccc; padding: 5px; margin-bottom: 10px;"> <p>GPI Coding Disabled</p> <ul style="list-style-type: none"> <li style="border: 1px solid #ccc; padding: 2px;">Disabled <li style="border: 1px solid #ccc; padding: 2px;">Edge <li style="border: 1px solid #ccc; padding: 2px;">Binary </div> <p>Edge GPI coding triggers on transitional state changes occurring on individual GPI inputs for the four states on the GUI (shown to the right).</p> <p>In this example, when GPI 2 “closes” (edge trigger going from HI to LO), Preset 7 is invoked. Preset 7 would be defined to invoke the settings desired for this GPI action.</p> <p>When GPI 2 “opens” (edge trigger going from LO to HI), Preset 8 is invoked. Preset 8 could be defined to invoke normal settings to revert to the pre-GPI condition. The state shown in bold is the currently active state.</p> <div style="border: 1px solid #ccc; padding: 5px; margin-bottom: 10px;"> <p>GPI 1 Disabled — Don't Care</p> </div> <div style="border: 1px solid #ccc; padding: 5px;"> <p>GPI 2</p> </div>	<p>Selects GPI triggering as follows:</p> <ul style="list-style-type: none"> • Disabled: GPI conditions on both GPI ports are ignored; no preset is invoked as a result of GPI status. Use this setting as a master disable of GPI functions. • Edge and Binary: See the description and examples below. <p>Note: Make certain GPI Trigger Coding is set to Disabled if GPI is not to be used. Selecting Binary triggering without controlled GPI inputs will result in inadvertently invoking a preset.</p> <div style="border: 1px solid #ccc; padding: 5px; margin-top: 10px;"> <p>GPI Coding Edge</p> <table border="1" style="width: 100%; border-collapse: collapse;"> <thead> <tr> <th style="background-color: #e0e0e0;">GPI State</th> <th style="background-color: #e0e0e0;">Preset Number</th> </tr> </thead> <tbody> <tr> <td>GPI 1 Open->Closed</td> <td style="text-align: center;">Disabled</td> </tr> <tr> <td>GPI 1 Closed->Open</td> <td style="text-align: center;">Disabled</td> </tr> <tr> <td>GPI 2 Open->Closed</td> <td style="text-align: center;">7</td> </tr> <tr> <td>GPI 2 Closed->Open</td> <td style="text-align: center;">8</td> </tr> </tbody> </table> </div>	GPI State	Preset Number	GPI 1 Open->Closed	Disabled	GPI 1 Closed->Open	Disabled	GPI 2 Open->Closed	7	GPI 2 Closed->Open	8
GPI State	Preset Number										
GPI 1 Open->Closed	Disabled										
GPI 1 Closed->Open	Disabled										
GPI 2 Open->Closed	7										
GPI 2 Closed->Open	8										
<p>Binary GPI coding triggers on conditions that consider state combinations on both GPI 1 and GPI 2 for the four state combinations on the GUI (shown to the right). This mode is useful where both GPIs must be considered before invoking an action.</p> <p>In this example, both GPIs are to be considered:</p> <ul style="list-style-type: none"> - “AES local insertion” on GPI 1 preempts network embedded audio by invoking Preset 2. - “EAS insertion” on GPI 2 preempts both network embedded audio and AES local insertion by invoking Preset 3. <p>Setting both of these drop-downs to Preset 3 sets rule for if GPI 2 is closed (LO), Preset 3 (“EAS insertion” in this example) is invoked regardless of open/close on GPI 1.</p> <div style="border: 1px solid #ccc; padding: 5px; margin-top: 10px;"> <p>GPI Coding Binary</p> <table border="1" style="width: 100%; border-collapse: collapse;"> <thead> <tr> <th style="background-color: #e0e0e0;">GPI State</th> <th style="background-color: #e0e0e0;">Preset Number</th> </tr> </thead> <tbody> <tr> <td>GPI 1-Closed / GPI 2-Closed</td> <td style="text-align: center;">3</td> </tr> <tr> <td>GPI 1-Closed / GPI 2-Open</td> <td style="text-align: center;">2</td> </tr> <tr> <td>GPI 1-Open / GPI 2-Closed</td> <td style="text-align: center;">3</td> </tr> <tr> <td>GPI 1-Open / GPI 2-Open</td> <td style="text-align: center;">1</td> </tr> </tbody> </table> </div> <div style="border: 1px solid #ccc; padding: 5px; margin-top: 10px;"> <p>GPI 1 (“AES local insertion”)</p> <p>GPI 2 (“EAS insertion”)</p> </div>	GPI State	Preset Number	GPI 1-Closed / GPI 2-Closed	3	GPI 1-Closed / GPI 2-Open	2	GPI 1-Open / GPI 2-Closed	3	GPI 1-Open / GPI 2-Open	1	<p>If GPI 1 is closed (LO), and GPI 2 is open, Preset 2 (“AES local insertion” in this example) is invoked.</p> <p>In this setup, when both GPI 1 and GPI 2 are open (HI), Preset 1 (“norm”, or go back to network embedded) is invoked. The state shown in bold is the currently active state.</p> <div style="border: 1px solid #ccc; padding: 5px; margin-top: 10px; width: fit-content;"> <p>See “Audio Routing with GPI Control Example” (p. 3-58) for an example showing the audio routing presets described here.</p> </div>
GPI State	Preset Number										
GPI 1-Closed / GPI 2-Closed	3										
GPI 1-Closed / GPI 2-Open	2										
GPI 1-Open / GPI 2-Closed	3										
GPI 1-Open / GPI 2-Open	1										

Table 3-2 9931-EMDE Function Menu List — continued

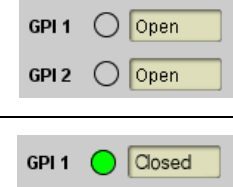
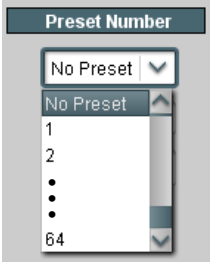
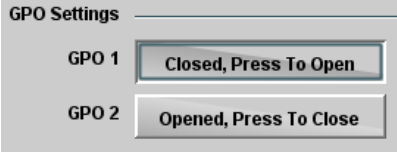
	<p>Allows up to 64 card user settings configuration presets to be saved in a Preset and then recalled (loaded) as desired. All current settings (including list selections and scalar (numeric) control settings such as Gain, etc.) are saved when a Preset Save is invoked.</p>
<p>Presets Event Based Loading</p>	

Presets allow convenient recall of custom user settings performed on the card. Presets are especially useful in defining card settings to invoke particular actions upon receiving a GPI trigger (see GPIO Controls (p. 3-52) for more information) or when used in conjunction with Event Based Preset invoke (see Event Based Preset Loading (p. 3-55) for more information).

When a preset is invoked, **only** the setting changes called by the preset are re-loaded, avoiding unnecessary delay or signal disruption that would otherwise result from a global control preset change.

The **Preset Name** field allows entry of names that are useful in describing the purpose or action of a particular preset, as shown in the examples here.

(Up to 62 ASCII characters can be entered.)

- Preset **Save** stores all current card control settings for the selected preset (in this example, pressing Save for Preset 1 (“norm”) saves all current card control settings to Preset 1 - norm).
- Pressing **Load** recalls a preset.
- Pressing **Delete** clears a preset. (After a delete, pressing **Load** replaces the deleted preset with factory default settings.)

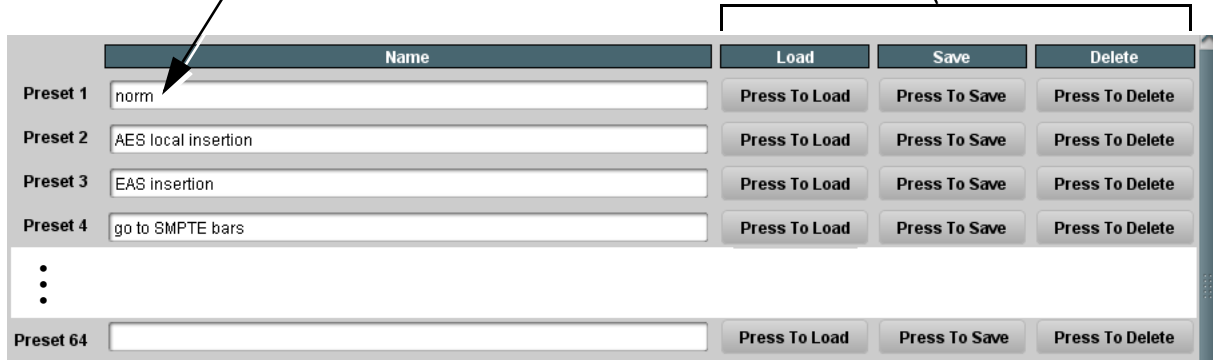

Download (save) card presets to a network computer by clicking **Download Presets** – **Save** at the bottom of the Presets page.



Browse to a desired save location (in this example, *My Documents\Cobalt Presets*).

The file can then be renamed if desired (*RCVR21 Presets* in this example) before committing the save.

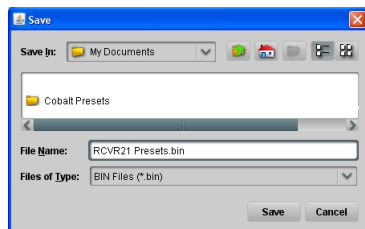

Upload (open) card presets from a network computer by clicking **Upload** at the bottom of Dashboard.



Browse to the location where the file was saved on the computer or drive (in this example, *My Documents\Cobalt Presets*).

Select the desired file and click **Open** to load the file to the card.

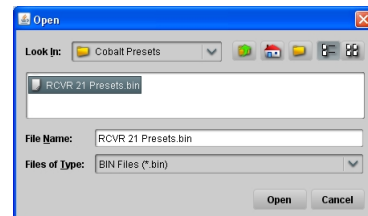

- Note:**
- Preset transfer between card download and file upload is on a **group** basis (i.e., individual presets cannot be downloaded or uploaded separately).
 - After uploading a presets file, engagement of a desired preset is only assured by pressing the Press To Load button for a desired preset.

Table 3-2 9931-EMDE Function Menu List — continued



	<p>(continued)</p>
<p>• Save/Delete Protect Button</p> 	<p>Locks and unlocks editing of presets to prevent accidental overwrite as follows:</p> <ul style="list-style-type: none"> • Unprotected: Allows preset Save and Delete buttons to save or delete current card settings to the selected preset. Use this setting when writing or editing a preset. • Protected: Toggle to this setting to lock down all presets from being inadvertently re-saved or deleted. Use this setting when all presets are as intended. <p>Note: When toggling between button modes, make sure to wait for the card Settings status indicator to turn green before moving on.</p>
	<p>Event-based loading allows a defined preset to be automatically engaged upon various received signal status. Event-based loading is particularly useful for automated card setup when transitioning from normal processing to processing supporting an alternate format.</p> <p>Up to 64 individual events can be defined and detected.</p>
<p>Note:</p> <ul style="list-style-type: none"> • Event Based Preset loading is not passive and can result in very significant and unexpected card control and signal processing changes if not properly used. If event based presets are not to be used, make certain the Event Based Preset Loading button is set to Disabled. • Because event based preset loading applies card control changes by invoking presets, loading conditions cannot be nested within a called preset (event-based loading settings performed here cannot be saved to presets). 	
<p>• Event Preset Load Select Controls</p> 	<p>Event based preset loading checks for up to three conditions (as described below) to all be true, and then invokes a selected preset when an ANDed true occurs. Up to 64 discrete events can be defined, with Event 1 having highest priority of engagement, and subsequently numbered events engaging in descending priority when true.</p> <p>Event-Based Preset Loading provides a global enable or disable for this function.</p> <p>Event status indicator shows if a defined event is true and has been automatically engaged.</p> <p>Acquired Video Format is condition A for three conditions comprising the overall event statement. Drop-down selector allows input video format received as condition A.</p> <p>Dolby Decoder Detected Format is condition B for three conditions comprising the overall event statement. Drop-down selector allows Dolby format received by the card Dolby decoder as condition B.</p> <p>Audio Silence Event Detected is condition C for three conditions comprising the overall event statement. See Audio Silence Configuration on page 3-57 for more information.</p> <p>If A*B*C = True, Go To: selects the card preset to go to when the defined conditions are true.</p> <p>Note:</p> <ul style="list-style-type: none"> • Any of the three conditions above can be set as a wildcard for any event definition by selecting Don't Care for the condition. • Cards not equipped with Dolby decoder (option +DEC) do not have Dolby Decoder Detected Format (B) event column. • Make certain Go To: for any event screening not to be used is set for No Preset. This prevents an event from unintentionally invoking a preset.

Table 3-2 9931-EMDE Function Menu List — continued

Event Based Presets

(continued)

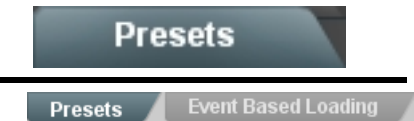
Event Based Loading

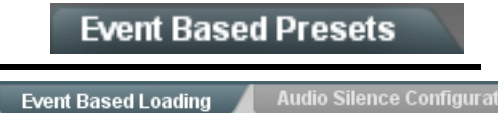
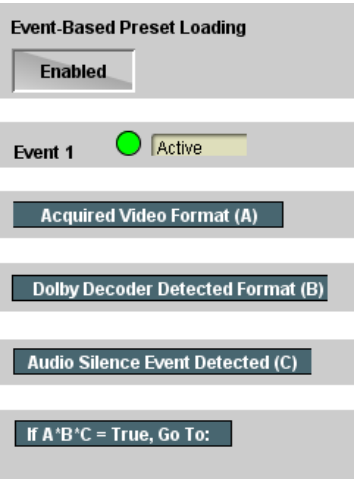
Audio Silence Configurati

In the example here, event-based presets are set to detect when an SD feed without Dolby E 5.1 is received. In this example, this event would invoke a failover preset that develops a 5.1-channel upmix to substitute for the normal HD 5.1-channel content decoded and applied to the card Dolby AC-3 encoder.

When the normal feed with Dolby E 5.1 is again received, a second event-based presets load returns to the card to normal processing (revert to using Dolby E 5.1 for the decoder source and AC-3 PCM source).

Events-Based Preset Loading set to **Enabled** turns on controls, allowing defined conditions to be checked.

Conditions **(A)**, **(B)**, and **(C)** for **Event 1** are set to recognize (when all true), an overall condition indicative of loss of normal HD feed. In this example:

- Video changing to SD format.
- Loss of Dolby E 5.1 at decoder input and instead audio consisting of PCM.
- Muting of audio on embedded channels that expectedly would contain 4 channels of multi-channel audio.

When all **Event 1** conditions are true, the selected preset is invoked. (In this example, Preset 8 would invoke upmixing a stereo PCM pair to 5.1 content.)

Conditions **(A)**, **(B)**, and **(C)** for **Event 2** are set to recognize (when all true), an overall condition indicative that the normal HD feed is again available. In this example:

- Video changing to 720p5994 format.
- Dolby E 5.1 again detected by the card Dolby decoder.

When all **Event 2** conditions are true, the selected preset is invoked. (In this example, Preset 1 would invoke routing decoded Dolby audio to the card audio bus.)

Note:

- Checked conditions are triggered upon start of event. Any event-based setup must be done in advance of the triggering event in order for event to be detected.
- Loss of true conditions does not disengage an event-based triggering. A new set of true conditions must be defined and then occur to transition from one event-based trigger to another.
- Time required to engage an event-based trigger depends upon complexity of the called preset. (For example, a preset that invokes multiple changes will take longer to engage than a preset involving only a simple audio routing change.)
- Make certain all definable event conditions that the card might be expected to “see” are defined in any of the Event 1 thru Event 64 rows. This makes certain that the card will always have a defined “go-to” preset if a particular event occurs. For example, if the card is expected to “see” a 720p5994 / Dolby E5.1+2 stream or as an alternate, a 525i5994 / PCM stream, make certain both of these conditions are defined (with your desired go-to presets) in any two of the Event 1 thru Event 64 condition definition rows.

3-56

9931-EMDE PRODUCT MANUAL

9931-EMDE-OM (V1.18)

Table 3-2 9931-EMDE Function Menu List — continued

Event Based Presets

Audio Silence Configuration allows definition of up to 16 embedded audio silence patterns to be detected as Condition C of the overall Events-Based loading.

Event Based Loading

Audio Silence Configuration

In the example here (and also correlating to the example on the previous page), **Audio Silence Event 1** is set to trigger if audio on Emb Ch 3 thru Ch 6 falls below the selected threshold for an interval exceeding the selected threshold (for example, a reversion to stereo audio instead of 5.1-channel audio).

If Audio Silence Event as a trigger condition is not desired, it can be set to Don't Care on the Event Based Loading sub-tab, or globally set to **Disabled** here.

Event Based Presets

Audio Silence Events

Enabled

	Emb Chan 1	Emb Chan 2	Emb Chan 3	Emb Chan 4	Emb Chan 5	Emb Chan 6	...	Emb Chan 16
Audio Silence Event 1	<input type="checkbox"/>	<input type="checkbox"/>	<input checked="" type="checkbox"/>	<input checked="" type="checkbox"/>	<input checked="" type="checkbox"/>	<input checked="" type="checkbox"/>		<input type="checkbox"/>
Audio Silence Event 2	<input type="checkbox"/>	<input type="checkbox"/>	<input type="checkbox"/>	<input type="checkbox"/>	<input type="checkbox"/>	<input type="checkbox"/>		<input type="checkbox"/>
⋮								
Audio Silence Event 16	<input type="checkbox"/>	<input type="checkbox"/>	<input type="checkbox"/>	<input type="checkbox"/>	<input type="checkbox"/>	<input type="checkbox"/>		<input type="checkbox"/>

Audio Failover Threshold (dBFS)

Primary to Secondary Holdoff (ms)

Secondary to Primary Holdoff (ms)

Event Based Loading

Audio Silence Configuration

Failover controls set the conditions that comprise a silence event, and also a transition back to an untriggered condition with resumption of audio for the selected embedded channels.

- If the selected channels maintain levels above the selected **Audio Failover Threshold**, no triggering is invoked.
- If these channels fall below the selected threshold for period specified by the **Primary to Secondary Holdoff** control, the respective Audio Silence Event trigger (condition C) goes true.
- **Secondary to Primary Holdoff** control sets the time in which the trigger is revoked upon an event false condition.

Note: Default threshold and holdoff settings shown here are recommended for typical use.

9931-EMDE-OM (V1.18)

9931-EMDE PRODUCT MANUAL

3-57

Audio Routing with GPI Control Example

Figure 3-7 shows an example of using the 9931-EMDE Routing controls, Audio DSP controls, and GPI controls to:

- Route an embedded network main 5.1-channel feed through the card (Emb Ch 1 thru Ch 6), but conditionally provide upmixing if the 5.1-channel complement is stereo audio only. Also, apply loudness processing before re-embedding it into the output SDI path.
- Provide stereo loudness processing for a network SAP stereo feed, and re-embed this pair into its original location (Emb Ch 7, 8).
- Provide the ability to replace the network main audio with that from a Local Insertion AES pair (AES pair 1) using a preset invoked by a ground closure on **GPI 1**.
- Provide the ability to replace the both the network main audio and SAP audio with that from an EAS receiver on AES pair 2 using a preset invoked by a ground closure on **GPI 2**.

A thru **E** on sheets 2 through 4 show the setups using the DashBoard™ tabs to accomplish the setup shown in sheet 1. Sheet 5 shows the use of presets to define the setups, and provide for GPI automated triggering of these setups.

Note that the source, internal bus, and destination correlations shown here are only examples; **any** source can route to **any** destination.

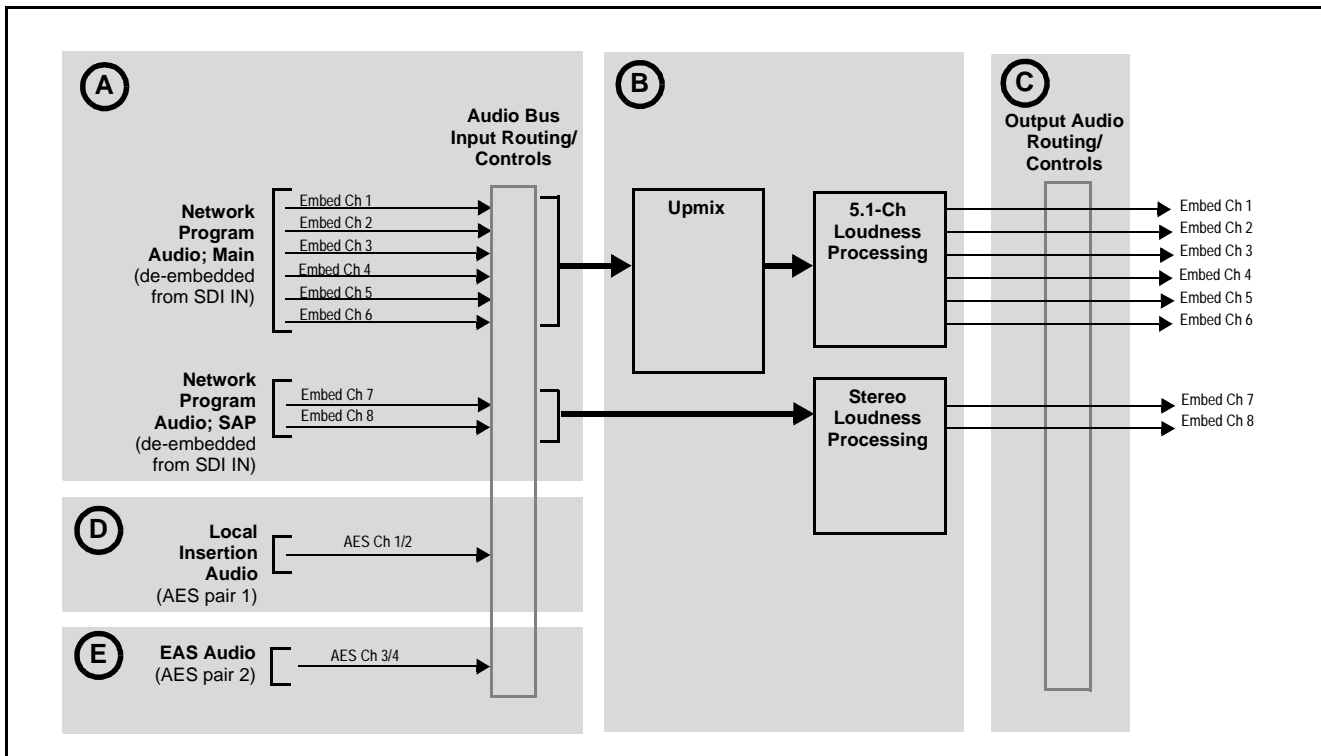
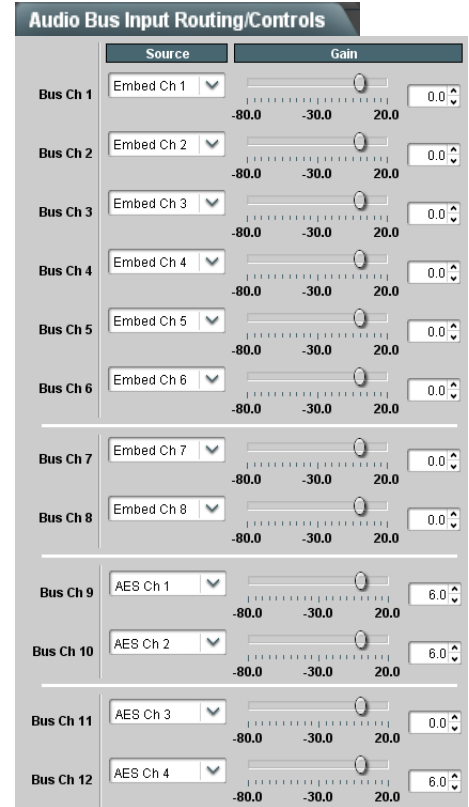
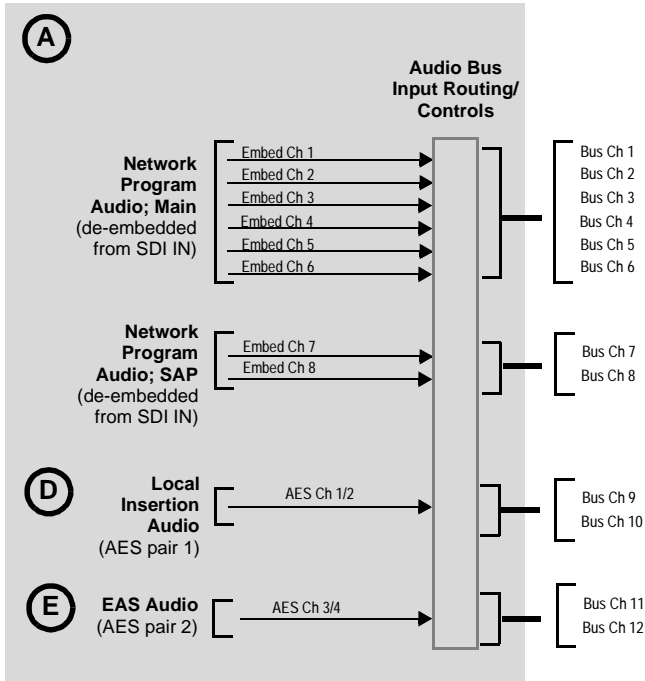

Figure 3-7 Audio Routing Example (Sheet 1 of 5)

The routing required to get all channels shown in **A**, **D** and **E** into the card processing is accomplished using the **Audio Bus Input Routing/Controls** tab (as shown to the right for this example). All signals coming into the card must first be placed on the bus to be accessed by card DSP functions, or to be outputted.



Because AES pair 1 (Local Insertion Audio) and AES pair 2 (EAS Audio) (AES Ch 1 thru AES Ch 4) are to be used as **inputs** for the routing in this example, **AES Ch 1 thru AES Ch 4** must be set as **AES Input** on the **Output Audio Routing/Controls > AES Audio Out** tabs as shown.

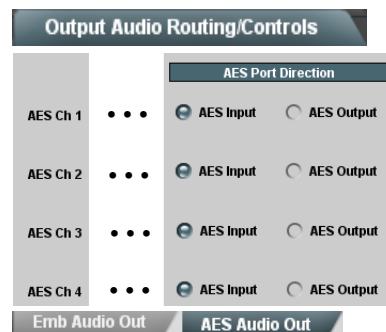

Figure 3-7 Audio Routing Example (Sheet 2 of 5)

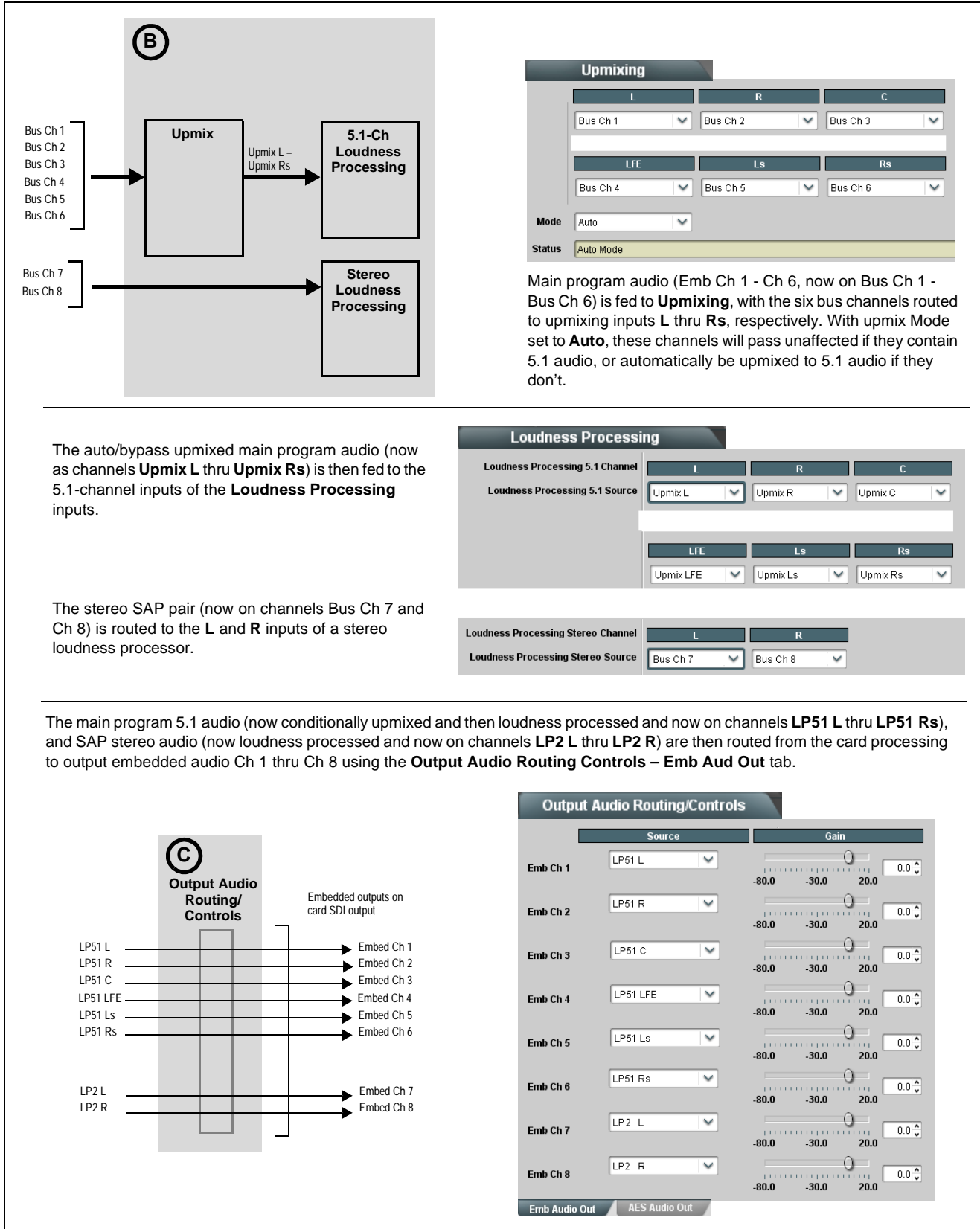
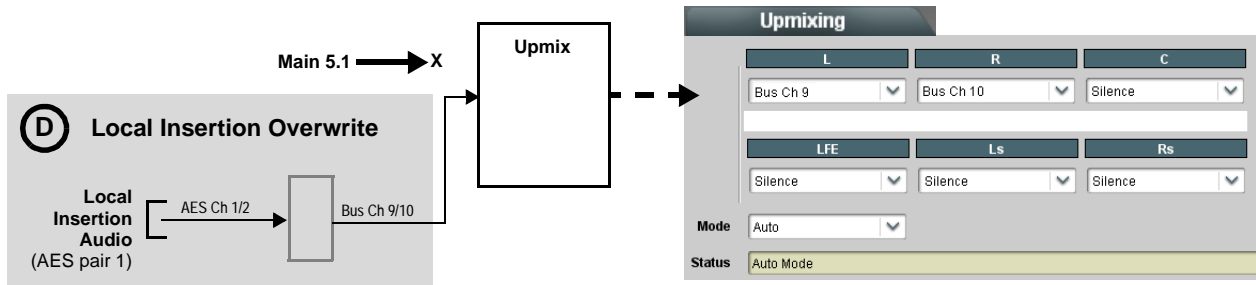

Figure 3-7 Audio Routing Example (Sheet 3 of 5)

Local insertion audio (from AES Ch 1/2 and now on Bus Ch 9/10) can replace the main program 5.1 audio with the routing shown below right. Because of the flexibility of the internal bus structure, the AES pair now replaces the main program audio and follows the same processing path as that used for the main 5.1 audio, with no other “downstream” routing changes required.

With the unused upmixer input channels set to silence, this will force an upmix of the received stereo pair in this example. This routing change performed on the **Upmixing** tab can be accomplished using a preset, allowing a single-button action to effect this routing. Incorporating this preset with the card **GPI** controls, this routing change can be automated.



Similar to the above example, EAS local insertion audio (from AES Ch 3/4 and now on Bus Ch 11/12) can replace the main program 5.1 and SAP audio (and AES local insertion, if active) with the routing shown above right. In this example, it is desired to route the EAS audio directly to the destination embedded output channels. This routing change is performed on the **Output Audio Routing/Controls** and can furthermore be automated when a preset is used in conjunction with a card GPI input (typically, an EAS receiver device has a logic signal input for this purpose).

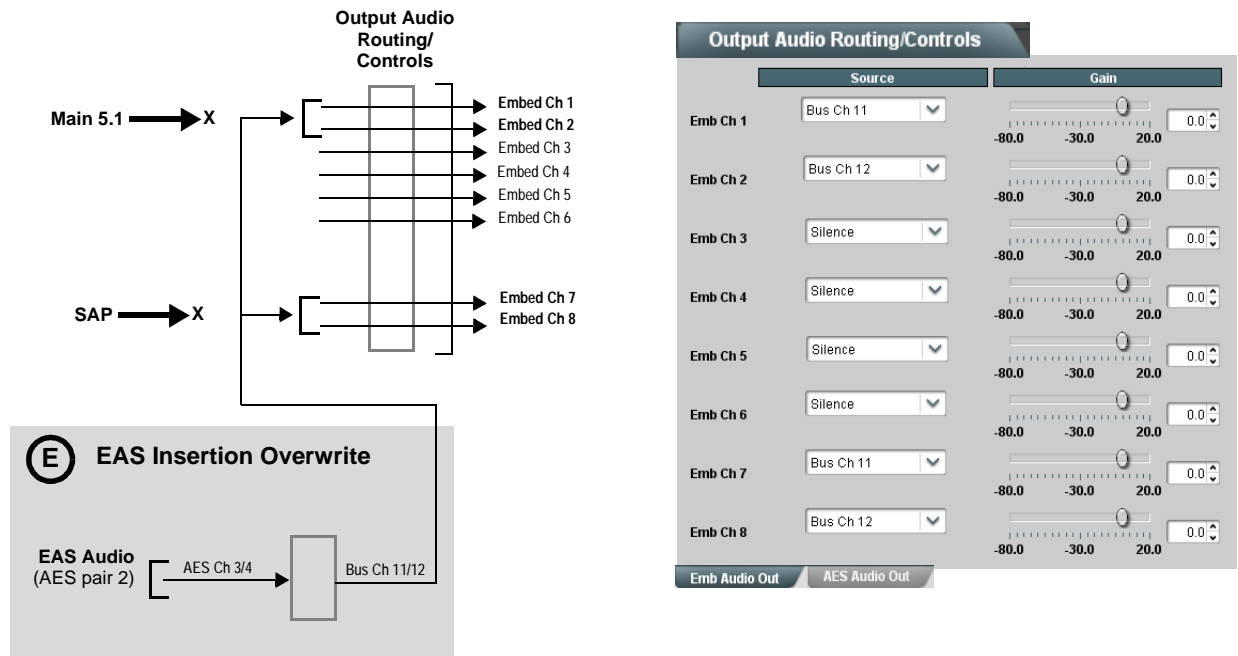

Figure 3-7 Audio Routing Example (Sheet 4 of 5)

Using the **Presets** and **GPI Controls** tabs, normal setup (shown in **A** thru **C** on the previous sheets), AES Local Insertion (shown in **D** in the previous sheets), and EAS Insertion (shown in **E** in the previous sheets) can be invoked using GPI 1 and GPI 2 card inputs as described here.

- Normal setup routing (**A** thru **C**) can be saved into Preset 1 (“norm”). This preset can be invoked to recall normal embedded routing following any GPI-invoked routing.
- AES Local Insertion routing changes (**D**) can be saved into Preset 2 (“AES local insertion”).
- EAS Insertion routing changes (**E**) can be saved into Preset 3 (“EAS insertion”).

Presets	
	Name
Preset 1	norm
Preset 2	AES local insertion
Preset 3	EAS insertion

The **GPI Controls** tab can then be set to invoke Preset 2 (“AES local insertion”) upon a GPI 1 closure (if GPI 2 is open), or invoke Preset 3 (“EAS insertion”) unconditionally upon a GPI 2 closure as shown to the right. Preset 1 applied to GPI 1 Open / GPI 2 Open recalls the normal routing following a GPI-invoked preset.

GPIO Controls	
GPI Coding	Binary
GPI State	
	Preset Number
GPI 1-Closed / GPI 2-Closed	3
GPI 1-Closed / GPI 2-Open	2
GPI 1-Open / GPI 2-Closed	3
GPI 1-Open / GPI 2-Open	1

Refer to GPIO Controls (p. 3-52) for more information about GPI coding and rules setting.

If GPI 1 closes and GPI 2 is open (as set by the **GPI Controls** settings shown above), Preset 2 (“AES local insertion”) would be invoked resulting in the routing changes shown below right. These are the routing changes saved to Preset 2 (and described in **D**) that replace the normal embedded channel routing with the AES local insertion pair.

Upmixing

L	R	C
Bus Ch 1	Bus Ch 2	Bus Ch 3
LFE	Ls	Rs
Bus Ch 4	Bus Ch 5	Bus Ch 6

Mode: Auto

Status: Auto Mode

➔

L	R	C
Bus Ch 9	Bus Ch 10	Silence
LFE	Ls	Rs
Silence	Silence	Silence

Mode: Auto

Status: Auto Mode

If GPI 2 closes (as set by the **GPI Controls** settings shown above), Preset 3 (“EAS insertion”) would be invoked resulting in the routing changes shown below right. These are the routing changes saved to Preset 3 (and described in **E**) that replace the normal embedded channel routing (and AES local insertion routing if active) with the EAS insertion pair.

Output Audio Routing/Controls

Source	Gain
Emb Ch 1: LP51 L	0.0
Emb Ch 2: LP51 R	0.0
Emb Ch 3: LP51 C	0.0
Emb Ch 4: LP51 LFE	0.0
Emb Ch 5: LP51 Ls	0.0
Emb Ch 6: LP51 Rs	0.0
Emb Ch 7: LP2 L	0.0
Emb Ch 8: LP2 R	0.0

Emb Audio Out AES Audio Out

➔

Source	Gain
Emb Ch 1: Bus Ch 11	0.0
Emb Ch 2: Bus Ch 12	0.0
Emb Ch 3: Silence	0.0
Emb Ch 4: Silence	0.0
Emb Ch 5: Silence	0.0
Emb Ch 6: Silence	0.0
Emb Ch 7: Bus Ch 11	0.0
Emb Ch 8: Bus Ch 12	0.0

Figure 3-7 Audio Routing Example (Sheet 5 of 5)

Troubleshooting

This section provides general troubleshooting information and specific symptom/corrective action for the 9931-EMDE card and its remote control interface. The 9931-EMDE card requires no periodic maintenance in its normal operation; if any error indication (as described in this section) occurs, use this section to correct the condition.

Error and Failure Indicator Overview

The 9931-EMDE card itself and its remote control systems all (to varying degrees) provide error and failure indications. Depending on how the 9931-EMDE card is being used (i.e., standalone or network controlled through DashBoard™ or a Remote Control Panel), check all available indications in the event of an error or failure condition.

The various 9931-EMDE card and remote control error and failure indicators are individually described below.

Note: The descriptions below provide general information for the various status and error indicators. For specific failures, also use the appropriate subsection listed below.

- Basic Troubleshooting Checks (p. 3-67)
- 9931-EMDE Processing Error Troubleshooting (p. 3-67)
- Troubleshooting Network/Remote Control Errors (p. 3-70)

9931-EMDE Card Edge Status/Error Indicators and Display

Figure 3-8 shows and describes the 9931-EMDE card edge status indicators and display. These indicators and the display show status and error conditions relating to the card itself and remote (network) communications (where applicable). Because these indicators are part of the card itself and require no external interface, the indicators are particularly useful in the event of communications problems with external devices such as network remote control devices.

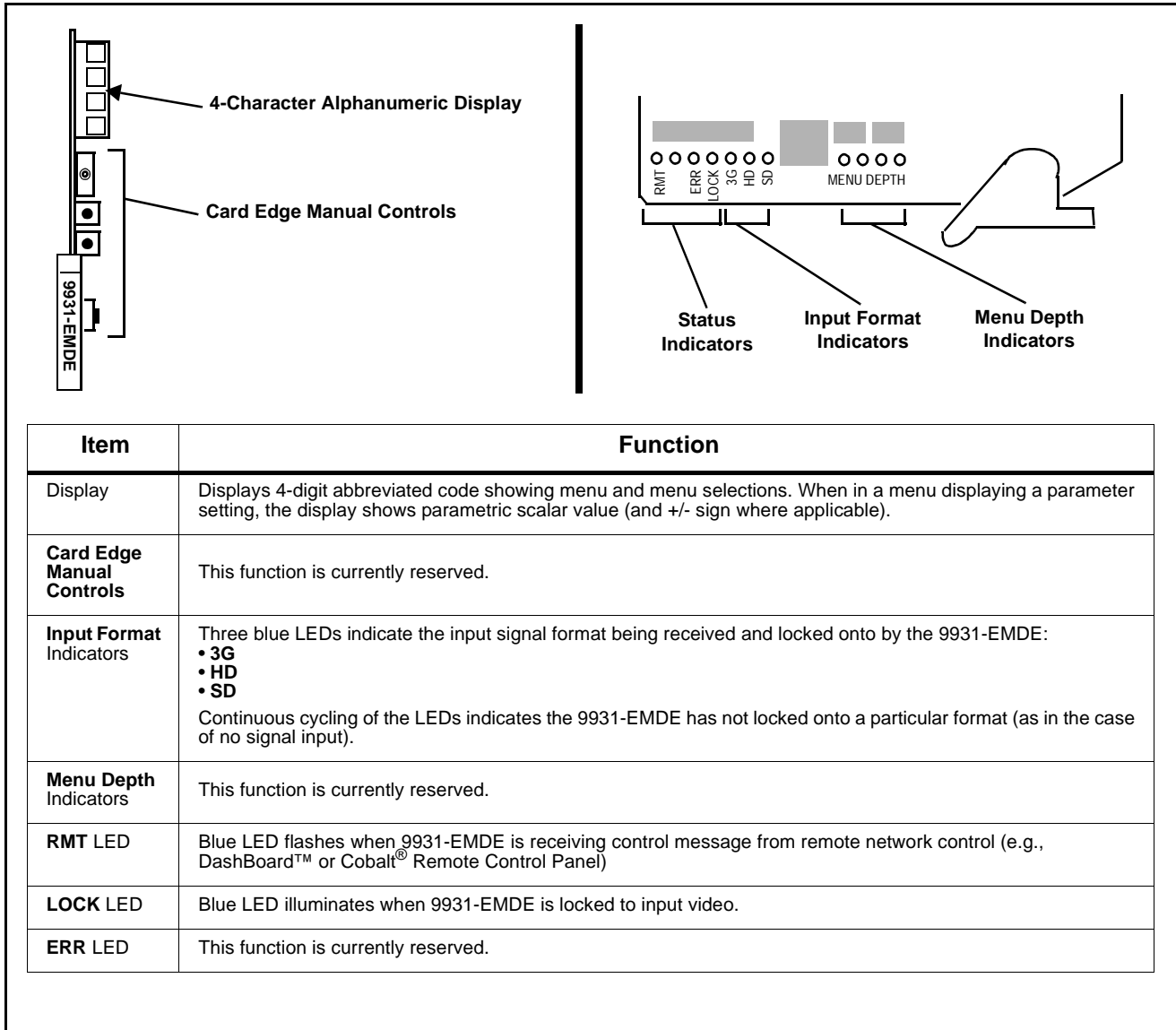

Figure 3-8 9931-EMDE Card Edge Status Indicators and Display

DashBoard™ Status/Error Indicators and Displays

Figure 3-9 shows and describes the DashBoard™ status indicators and displays. These indicator icons and displays show status and error conditions relating to the 9931-EMDE card itself and remote (network) communications.



Indicator Icon or Display	Error Description
	<p>Red indicator icon in Card Access/Navigation Tree pane shows card with Error condition (in this example, the Card Access/Navigation Tree pane shows a general error issued by the 9931-EMDE card in slot 6).</p> <p>Specific errors are displayed in the Card Info pane (in this example "No connection to device" indicating 9931-EMDE card is not connecting to frame/LAN).</p> <p>If the 9931-EMDE card is not connecting to the frame or LAN, all controls are grayed-out (as shown in the example here).</p>
	<p>Gray indicator icon in Card Access/Navigation Tree pane shows card(s) are not being seen by DashBoard™ due to lack of connection to frame LAN (in this example, both a 9931-EMDE card in slot 6 and the MFC-8320-N Network Controller Card for its frame in slot 0 are not being seen).</p>
	<p>Yellow indicator icon in Card Access/Navigation Tree pane shows card with Alert condition (in this example, the Card Access/Navigation Tree pane shows a general alert issued by the MFC-8320-N Network Controller Card).</p> <p>Clicking the card slot position in the Card Access/Navigation Tree (in this example Network Controller Card "Slot 0: MFC-8320-N") opens the Card Info pane for the selected card. In this example, a "Fan Door Open" specific error is displayed.</p>
	<p>Yellow indicator icon in 9931-EMDE Card Info pane shows error alert, along with cause for alert (in this example, the 9931-EMDE is receiving no video input, or a video input that is invalid for the card and/or its current settings).</p>

Figure 3-9 DashBoard™ Status Indicator Icons and Displays

Access the Card Info pane for a specific card by clicking the card slot position in the Card Access/Navigation Tree pane (as shown in the example in Figure 3-10).

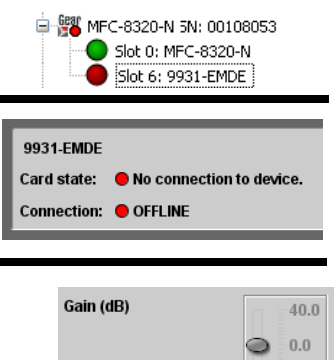
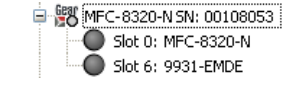
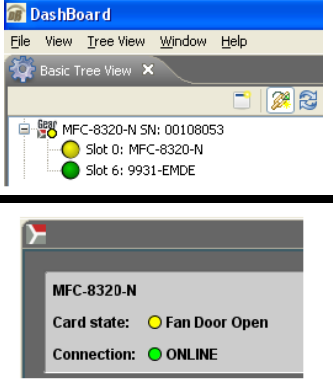
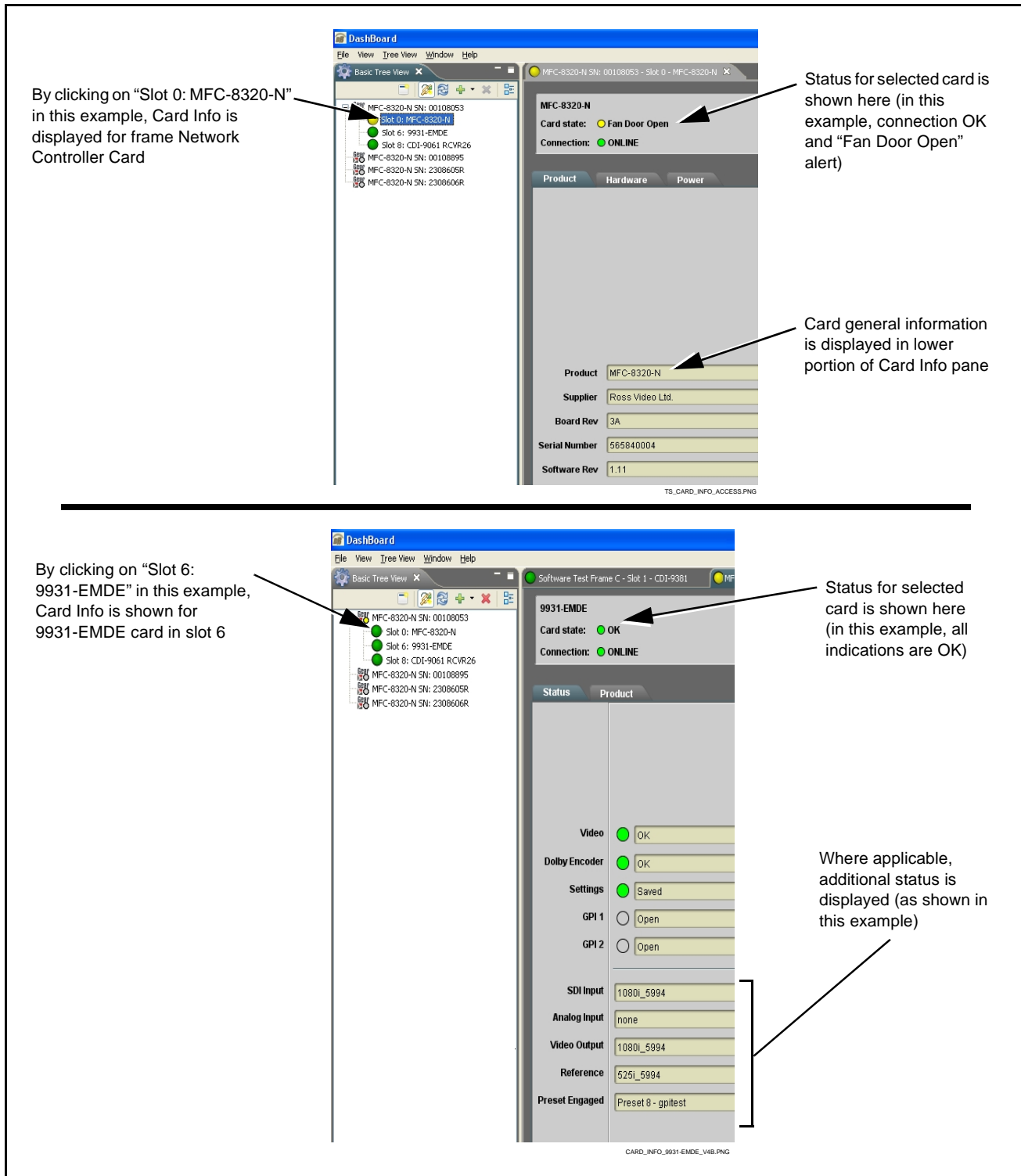

Figure 3-10 Selecting Specific Cards for Card Info Status Display

Basic Troubleshooting Checks

Failures of a general nature (affecting many cards and/or functions simultaneously), or gross inoperability errors are best addressed first by performing basic checks before proceeding further. Table 3-3 provides basic system checks that typically locate the source of most general problems. If required and applicable, perform further troubleshooting in accordance with the other troubleshooting tables in this section.

Table 3-3 Basic Troubleshooting Checks

Item	Checks
Verify for power presence	On both the frame Network Controller Card and the 9931-EMDE, in all cases when power is being properly supplied there is always at least one indicator illuminated. Any card showing no illuminated indicators should be cause for concern.
Check Cable connection secureness and connecting points	Make certain all cable connections are fully secure (including coaxial cable attachment to cable ferrules on BNC connectors). Also, make certain all connecting points are as intended. Make certain the selected connecting points correlate to the intended card inputs and/or outputs. Cabling mistakes are especially easy to make when working with large I/O modules.
Card seating within slots	Make certain all cards are properly seated within its frame slot. (It is best to assure proper seating by ejecting the card and reseating it again.)
Check status indicators and displays	On both DashBoard™ and the 9931-EMDE card edge indicators, red indications signify an error condition. If a status indicator signifies an error, proceed to the following tables in this section for further action.
Troubleshoot by substitution	All cards within the frame can be hot-swapped, replacing a suspect card or module with a known-good item.

9931-EMDE Processing Error Troubleshooting

Table 3-4 provides 9931-EMDE processing troubleshooting information. If the 9931-EMDE card exhibits any of the symptoms listed in Table 3-4, follow the troubleshooting instructions provided.

In the majority of cases, most errors are caused by simple errors where the 9931-EMDE is not appropriately set for the type of signal being received by the card.

Note: The error indications shown below are typical for the corresponding error conditions listed. Other error indications not specified here may also be displayed on DashBoard™ and/or the 9931-EMDE card edge status indicators.

Note: Where errors are displayed on both the 9931-EMDE card and network remote controls, the respective indicators and displays are individually described in this section.

Table 3-4 Troubleshooting Processing Errors by Symptom

Symptom	Error/Condition	Corrective Action
<ul style="list-style-type: none"> DashBoard™ shows Video yellow icon and Input Invalid message in 9931-EMDE Card Info pane.  <ul style="list-style-type: none"> Card edge Input Format LEDs show continuous cycling. 	No video input present	Make certain intended video source is connected to appropriate 9931-EMDE card video input. Make certain BNC cable connections between frame Rear I/O Module for the card and signal source are OK.
<ul style="list-style-type: none"> (+FS option only) DashBoard™ shows none in Reference message in Card Info pane. 	Frame sync reference not properly selected or not being received	<ul style="list-style-type: none"> If external frame sync reference is not intended to be used, make certain the Framesync Mode selection list is set to Free Run or Input Video as desired. If external frame sync reference is intended to be used, make certain selected external frame sync reference is active on frame sync frame bus. (External reference signals Reference 1 and Reference 2 are distributed to the 9931 and other cards via a the frame bus.) <p>Refer to Framesync function menu tab on page 3-21 for more information.</p>
Card does not pass video or audio as expected. Control settings spontaneously changed from expected settings.	Event-based preset inadvertently invoked	<p>Event-based preset loading should be set to Disabled if this function is not to be used. Read and understand this control description before using these controls to make sure engagement for all expected conditions is considered. See Event Based Preset Loading (p. 3-55) for more information.</p> <p>Audio routing can be affected by failover controls that are located on the Audio Bus Input/Routing tab. See Audio Bus Input Routing/Controls (p. 3-32) for more information.</p>
Video/audio synchronization or delay noted.	Source synchronization condition	<p>Use the Audio/Video Delay Offset controls to compensate for video/audio delay.</p> <p>Refer to Audio Bus Input Routing/Controls function menu tab on page 3-32 for more information.</p>
Ancillary data (closed captioning, timecode, Dolby® metadata, AFD) not transferred through 9931-EMDE.	VANC line number conflict between two or more ancillary data items	Make certain each ancillary data item to be passed is assigned a unique line number (see Ancillary Data Line Number Locations and Ranges on page 3-9).
AES audio not processed or passed through card.	AES Port Direction Select not set to match intended use for AES rear module port.	<p>Each AES channel pair has port direction selectors that set the AES as input or output. Make certain port is set as input or output, as intended, in accordance with Output Audio Routing/Controls (p. 3-42).</p>

Table 3-4 Troubleshooting Processing Errors by Symptom — continued

Symptom	Error/Condition	Corrective Action
Analog audio not processed or passed through card.	Analog input/output DIP switches not set to match intended use for analog rear module port.	Each analog channel corresponding to rear module analog audio ports has input/output port direction selectors that set the AES as input or output. Make certain port is set as input or output, as intended, in accordance with Setting I/O Switches for Analog Audio (1-8) Ports (p. 2-1).
(+ENCD, +ENCE options only) Encoder will not accept external RS-485 metadata.	RS-485 A and B signals reversed (“flipped”).	Conventions using RS-485 are not always consistent across devices. If the A and B differential feeds are reversed, the encoder will not recognize the signal. This card uses the following convention per EIA-485: <ul style="list-style-type: none"> A is inverting (–) pin B is non-inverting (+) pin G is ground/common Reversing the A and B connections in this error case typically solves this problem.
Card will not retain user settings, or setting changes or presets spontaneously invoke.	<ul style="list-style-type: none"> • GPI Controls tab GPI Coding set to Binary with no controlled GPI source connected to GPI inputs 	<ul style="list-style-type: none"> • If GPI is not to be used, make certain GPI Coding control on GPI Controls tab is set to Disabled. (If control is left on Binary with no inputs, the pull-up HI logic state on the open inputs will be interpreted as two “HI’s” on the inputs, resulting in an invoked preset).
	<ul style="list-style-type: none"> • Event Based Loading sub-tab inadvertently set to trigger on event 	<ul style="list-style-type: none"> • If event based loading is not to be used, make certain Event Based Presets is disabled (either using master Enable/Disable control or through events settings. See Event Based Preset Loading (p. 3-55) for more information.
Card spontaneously disconnects from remote control; card displays red error card-edge LED	<ul style="list-style-type: none"> • Card software error 	<ul style="list-style-type: none"> • In the extremely unlikely case this error occurs, the card will display <div style="border: 1px solid gray; padding: 5px; margin: 10px 0;"> <p>Slot 18: 9901-UDX</p> <p>Card state: ● Log status A critical Error has occurred</p> <p>Connection: ● ONLINE</p> <hr/> <p>Status Product</p> </div> <ol style="list-style-type: none"> 1. Go to the Log tab and follow the on-screen instructions to download the generated log file to connected computer. After the file downloads, the card reboots and the error indication will be cleared. 2. Send the log file to Cobalt product support. Cobalt Engineering will analyze the log and typically respond with corrective action.

Troubleshooting Network/Remote Control Errors

Refer to Cobalt® reference guide “COMPASS™ Remote Control User Guide” (PN 9000RCS-RM) for network/remote control troubleshooting information.

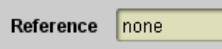
What To Do If Your Card Locks Up

In very rare cases of the card locking up during a firmware upgrade (such as power interruption during a card firmware upgrade), the card can be set to boot from its non-volatile file (“safe image”) held in card ROM.

When the safe image is loaded, the card is now rebooted/unlocked and can receive a target firmware upgrade .bin file (which, if not stored on your computer can be downloaded from **Support>Firmware Download** link at www.cobaltdigital.com).

Perform the following steps **in the order listed** as necessary until normal operation is restored.

NOTE: Your card's Presets may be erased following this procedure. You may be able to re-apply them after performing this procedure as described in **Uploading Your Presets** on the next page.

4-character display

9931-EMDE

- ① Place the card in its frame slot but do not fully insert into slot yet.
- ② Hold the lower button in and slide the card into a powered slot.
- ③ With card fully in slot, continue holding the button for about 3 seconds then release it.
- ④ When the card-edge 4-character display shows `BOOT`, the card is now rebooted and ready to receive its firmware .bin operating file.

Status		Product	
Product	9901-UDX		
Product Options	+AES, +ANAIO, +ANAVI, +ANAVO, +WINGS, +KEYE		
Manufacturer	Cobalt Digital Inc.		
Serial Number	324693		
Software Version	1.0.7082		
Processor Type	B		
FPGA Version	1.0.7037.129, recovery image		

- ⑤ Open the card in DashBoard and observe its **Product** tab. Note the recovery image now shown in the **FPGA Version** field. This indicates that the card is ready to receive its operating firmware .bin file
- ⑥ Upload the desired card firmware .bin file as described in the **Support>Firmware Download** link at www.cobaltdigital.com.

In Case of Problems

Should any problem arise with this product that was not solved by the information in this section, please contact the Cobalt Digital Inc. Technical Support Department.

If required, a Return Material Authorization number (RMA) will be issued to you, as well as specific shipping instructions. If required, a temporary replacement item will be made available at a nominal charge. Any shipping costs incurred are the customer's responsibility. All products shipped to you from Cobalt Digital Inc. will be shipped collect.

The Cobalt Digital Inc. Technical Support Department will continue to provide advice on any product manufactured by Cobalt Digital Inc., beyond the warranty period without charge, for the life of the product.

See Contact Cobalt Digital Inc. (p. 1-32) in Chapter 1, "Introduction" for contact information.

This page intentionally blank



Cobalt Digital Inc.

2506 Galen Drive
Champaign, IL 61821
Voice 217.344.1243 • Fax 217.344.1245
www.cobaltdigital.com