

Cobalt Digital Inc.

**BBG-1123-ENC (Single-Channel)**  
**BBG-1123-ENC2 (Dual-Channel)**  
**9223-SA-S (Single-Channel)**  
**9223-SA-D (Dual-Channel)**  
**9223-S (openGear® Single-Channel)**  
**9223-D (openGear® Dual-Channel)**  
**3G/HD/SD MPEG-4 AVC Encoders**

**Product Manual**

**Version 3.2.0**

**COBALT**

**openGear**

**BBG-1123-ENC/9223-SA/9223-OM**

**Version: 3.2.0**

---

---

## BBG-1123-ENC/9223-SA/9223 • Single/Dual-Channel 3G/HD/SD MPEG-4 AVC Encoder Units Product Manual

- Cobalt Digital Inc. Part Number: **BBG-1123-ENC/9223-SA/9223-OM**
- Document Version: **3.2.0**
- Printed in the United States.
- Last Author: CAN
- Printing Date: 12/3/2020

The information contained in this manual is subject to change without notice or obligation.

---

### Copyright

© 2018-2020 Cobalt Digital Inc. All rights reserved.

Contents of this publication may not be reproduced in any form without the written permission of Cobalt Digital Inc. Reproduction or reverse engineering of copyrighted software is prohibited.

---

### Notice

The material in this manual is furnished for informational use only. It is subject to change without notice and should not be construed as commitment by Cobalt Digital Inc. Cobalt Digital Inc. assumes no responsibility or liability for errors or inaccuracies that may appear in this manual.

---

### Trademarks

-  is a registered trademark of Ross Video Limited.
- [COBALT](#) is a registered trademark of Cobalt Digital Inc.
- DashBoard Control System™ is a trademark of Ross Video Limited.

All other product names and any registered and unregistered trademarks mentioned in this manual are used for identification purposes only and remain the exclusive property of their respective owners.

---

# Safety Instructions for the BBG-1123-ENC and 9223-SA Appliances

**Note:** In this manual, “9223-ENC” refers to either of the following. Where differences apply, the units are discussed separately.

- **BBG-1123-ENC2** – Dual-Channel Encoder
- **BBG-1123-ENC** – Single-Channel Encoder
- **9223-SA-D** – Dual-Channel Encoder
- **9223-SA-S** – Single-Channel Encoder

The 9223-ENC appliance is turned off by using the power switch. Power may still be present in the appliance. To ensure that the appliance is completely shut down, unplug its power cord from its power source.

The 9223-ENC appliance ships with all required components installed. There is no need to open the chassis to add or remove components. Please contact Product Support regarding any malfunction or failure of the device.

## ***Safety Notice and Warnings***

### **FCC Notice**

This device complies with Subpart B of Part 15 of the FCC Rules. Operation is subject to the following two conditions:

- This device may not cause harmful interference.
- This device must accept any interference received, including interference that may cause undesired operation.

No Telecommunications Network Voltage (TNV)-connected PCBs shall be installed.

### **Other Certifications**

This class A digital apparatus complies with Canadian ICES-003, Issue 4.

*Cet appareil numérique de la classe A est conforme à la norme NMB-003 du Canada.*

This device complies with EN 55022 standards.

This device complies with EN 61000-3-2 standards.

This device complies with EN 61000-4-2 standards.

This device complies with CISPR 22 Edition 6.

This device complies with AS/NZS CISPR 22.

### **CE Mark Warning**

This is a Class A product. In a domestic environment, this product may cause radio interference, in which case the user may be required to take adequate measures.

---

## Installation Safety Notes

- Do not place the 9223-ENC appliance underneath heavy loads or in an unstable position.
- Do not expose the 9223-ENC appliance under direct sunlight, high humidity or wet conditions.
- Do not use or expose the 9223-ENC appliance around magnetic fields as magnetic interference may affect the performance of the device.
- Do not block the air vents to this device or impede the airflow in any way.



### **Important Safety Information!** Please note the following:

1. The 9223-ENC is intended for indoor use only.
2. In case of emergency, disconnect the power cords.
3. If power cords are not provided:
  - In the United States, use standard computer power cords (as specified below).
  - In Europe, for 230 volt operation, use a cord set marked “HAR” and consisting of a min 3 core H05VVF3G075 cord that has a minimum 0.75 square mm diameter conductors, provided with an IEC 320 receptacle and a male plug for the country of installation, rated 6A, 250V.
4. Do not block the equipment vents.

READ THE FOLLOWING SAFETY INFORMATION THOROUGHLY BEFORE INSTALLING THIS PRODUCT. FAILURE TO FOLLOW THIS SAFETY INFORMATION MAY LEAD TO PERSONAL INJURY OR DAMAGE TO THE EQUIPMENT.

### **Power Supply**

- This unit must be grounded.
- The unit must be connected to a grounded outlet to comply with product safety standards.
- The grounded socket-outlet shall be installed near the equipment and shall be easily accessible.
- Do not connect the power supply unit to an AC outlet without a ground connection.
- All power cords must be disconnected before servicing.

### **Power Cords**

The plug on the power supply cords is considered to be the equipment disconnect device and must be approved for the country where it is used.

For USA and Canada:

- The cord set must be UL-approved and CSA-certified.
- The attachment plug must be an earth-grounding type with a NEMA 5-15P (15A 125V) plug and an EN60320/IEC320 receptacle.

---

## ***Electrostatic Discharge (ESD) and ESD Protection***

Static electricity can damage boards, and other components. Before connecting or disconnecting any device to the 9223-ENC appliance, we recommend you discharge static electricity by first touching a metal part of a grounded PC.



**CAUTION:** To reduce the risk of electric shock, do not open chassis; do not defeat or remove the ground pin of the power cord; connect only to a properly grounded ac power outlet. No user-serviceable parts inside. Refer servicing to qualified service personnel.

---

# Important Regulatory and Safety Notices

Before using this product and any associated equipment, refer to the “**Important Safety Instructions**” listed below to avoid personnel injury and to prevent product damage.

Products may require specific equipment, and/or installation procedures to be carried out to satisfy certain regulatory compliance requirements. Notices have been included in this publication to call attention to these specific requirements.

## Symbol Meanings



---

*This symbol on the equipment refers you to important operating and maintenance (servicing) instructions within the Product Manual Documentation. Failure to heed this information may present a major risk of damage or injury to persons or equipment.*



---

**Warning** — *The symbol with the word “Warning” within the equipment manual indicates a potentially hazardous situation which, if not avoided, could result in death or serious injury.*



---

**Caution** — *The symbol with the word “Caution” within the equipment manual indicates a potentially hazardous situation which, if not avoided, may result in minor or moderate injury. It may also be used to alert against unsafe practices.*



---

**Notice** — *The symbol with the word “Notice” within the equipment manual indicates a situation, which if not avoided, may result in major or minor equipment damage or a situation which could place the equipment in a non-compliant operating state.*



---

**ESD Susceptibility** — *This symbol is used to alert the user that an electrical or electronic device or assembly is susceptible to damage from an ESD event.*

---

## Important Safety Instructions



---

**Caution** — *This product is intended to be a component product of an 8300 series frame. Refer to the frame User Manual for important safety instructions regarding the proper installation and safe operation of the frame as well as its component products.*



---

**Warning** — *Certain parts of this equipment namely the power supply area still present a safety hazard, with the power switch in the OFF position. To avoid electrical shock, disconnect all A/C power cards from the chassis’ rear appliance connectors before servicing this area.*

---



---

**Warning** — *Service barriers within this product are intended to protect the operator and service personnel from hazardous voltages. For continued safety, replace all barriers after any servicing. This product contains safety critical parts, which if incorrectly replaced may present a risk of fire or electrical shock. Components contained with the product's power supplies and power supply area, are not intended to be customer serviced and should be returned to the factory for repair. To reduce the risk of fire, replacement fuses must be the same time and rating. Only use attachments/accessories specified by the manufacturer.*

---

## Maintenance/User Serviceable Parts

Routine maintenance to this Cobalt Digital Inc. product is not required. This product contains no user serviceable parts. If the frame does not appear to be working properly, please contact Technical Support using the numbers listed under the “Contact Us” section on the last page of this manual. All Cobalt Digital Inc. products are covered by a generous 5-year warranty and will be repaired without charge for materials or labor within this period. See the “Warranty and Repair Policy” section in this manual for details.

## Environmental Information

**The equipment that you purchased required the extraction and use of natural resources for its production. It may contain hazardous substances that could impact health and the environment.**

To avoid the potential release of those substances into the environment and to diminish the need for the extraction of natural resources, Cobalt Digital Inc. encourages you to use the appropriate take-back systems. These systems will reuse or recycle most of the materials from your end-of-life equipment in an environmentally friendly and health conscious manner.

The crossed-out wheeled bin symbol invites you to use these systems.

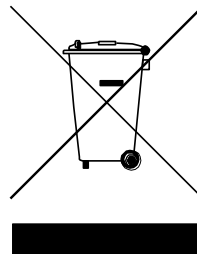

If you need more information on the collection, reuse, and recycling systems, please contact your local or regional waste administration.

You can also contact Cobalt Digital Inc. for more information on the environmental performances of our products.

---

## Contents

Safety Instructions for the BBG-1123-ENC and 9223-SA Appliances.....	3
Safety Notice and Warnings .....	3
FCC Notice .....	3
Other Certifications.....	3
CE Mark Warning.....	3
Installation Safety Notes .....	4
Electrostatic Discharge (ESD) and ESD Protection .....	5
Contents .....	8
Introduction.....	11
Product Overview .....	11
ASI/IP Streaming.....	12
OTT and RIST Protocols .....	13
Connecting BBG-1123-ENC to DashBoard Network Remote Control .....	14
Connecting 9223-SA to DashBoard Network Remote Control.....	17
BBG-1123-ENC Indicators and Switches .....	21
Back Panel .....	21
Front Panel Indicators.....	23
The Presets Menu.....	24
The Config Menu.....	25
The Status Menu .....	25
Factory Configuration Reset.....	26
9223-SA Indicators and Switches.....	27
Back Panel .....	27
Front Panel Indicators.....	29
Front Panel Default Switch.....	30
9223 Indicators and Switches .....	31
Rear I/O Panel Indicators.....	31
Front Indicators.....	32
Front Switches .....	33
9223-ENC Operation and Management.....	35
Product Tab.....	36
Network Tab .....	38
Network Configuration Tab.....	38
Network Configuration Interfaces Tab .....	38
Network Configuration DNS Tab.....	39
Network Configuration RIST Tunnels Tab .....	40
Network Statistics Tab.....	42
Network Statistics Interfaces Tab .....	42
Network Statistics DNS Tab.....	43
Network Statistics RIST Tunnels Tab .....	43
Network Statistics Tunnel Stats Tab.....	44
Network Statistics Remote Info Tab.....	45
Encoder 1, Encoder 2 Tabs .....	47
Encoder Configuration Tab.....	47
Video Input Auto-Detection .....	48



---

Multiple Audio Support .....	48
Encoder Basic Configuration Tab.....	50
Basic Tab – General Configuration .....	51
Basic Tab – Video Configuration .....	53
Basic Tab – Audio Configuration .....	57
Basic Tab – Additional Audio Support.....	60
Basic Tab – Secondary Audio Support.....	62
Encoder Advanced Configuration Tab .....	63
Advanced Tab – Video Parameters.....	64
Advanced Tab – VBI/Ancillary Data Insertion .....	66
Advanced Tab – Audio Parameters .....	72
Advanced Tab – Additional Audio Channels .....	74
Advanced Tab – Mux Parameters.....	75
Encoder Connections Tab.....	78
ASI/IP Streaming.....	79
HTTP Live Streaming.....	79
Direct HTTP Streaming .....	83
RTMP.....	84
RIST .....	88
The Apply/Cancel Buttons.....	90
Encoder Statistics Tab.....	90
Encoder Status .....	91
ASI Outputs Tab .....	102
ASI Ports: Configuration Tab .....	102
ASI Ports: Statistics Tab .....	104
IP Outputs Tab .....	105
IP Outputs: Configuration Tab.....	105
SMPTE 2022 FEC Support.....	108
Completing the Configuration .....	110
Active IP Outputs Table.....	110
Managing Unicast MAC Addresses.....	112
IP Outputs: Statistics Tab.....	112
Connections Tab .....	114
Connections Configuration Tab.....	114
Source Selection.....	114
Destination Selection .....	115
Source Selection in the Output Ports .....	116
The Established Connections Table.....	116
Connection Statistics Tab .....	117
MPTS Configuration Tab .....	118
MPTS Configuration Parameters.....	119
MPTS PID/Program Allocation .....	119
MPTS Statistics Tab .....	121
Admin Tab .....	122
Admin General Tab.....	122
Admin Firmware Tab.....	123

---

Admin Config Files Tab .....	125
User-Saved Configurations .....	126
Pre-defined Templates .....	128
Clear Current Configuration Button .....	129
Admin Test Packet Generator Tab.....	129
Admin License Keys Tab.....	131
Admin Event Log Tab .....	133
Control Tab .....	137
Control Port Configuration Tab .....	137
Control Port Statistics Tab .....	138
SNMP Configuration Tab .....	139
SNMP Statistics Tab .....	140
Support Tab.....	141
Playing Video on a Web Page .....	142
Web Pages Served by the 9223-ENC .....	143
Multicast Streaming .....	144
HTTP Live Streaming.....	147
Direct HTTP Streaming .....	147
Using a Firewall Between the 9223-ENC and the Internet.....	147
Web Browser Support.....	148

---

## Introduction

This manual covers the following products:

- The BBG-1123-ENC standalone H.264 SD/HD single and dual-channel encoder appliances
- The 9223-SA standalone H.264 SD/HD single and dual-channel encoder appliances
- The 9223 openGear® H.264 SD/HD single and dual-channel encoder cards

All products have the same set of features, and essentially the same user interface. Unless specifically indicated, all features and controls described in this manual apply to all products. In this manual, the product is generically referred to as the “Encoder” or 9223-ENC.

The encoders have the following features:

- Video Encoding support: up to two channels of SD or HD H.264 encoding, with a maximum resolution of 1920×1080p60 per channel.
- Audio Encoding support: up to two channels of MPEG-1 Layer II or AAC-LC.
- Video Inputs: support for composite, SD-SDI, HD-SDI, and 3G-SDI.
- Audio Inputs: support for analog audio, and SDI embedded digital audio.
- Outputs: 2 ASI ports and 2 Ethernet ports, supporting 100 Mb/s and 1 Gb/s operation.
- Replication: each encoded stream can be replicated on both ASI ports and 4 times on each Ethernet port.
- Support for UDP/RTP on Ethernet.
- Support for Over-The-Top (OTT) protocols: HTTP Live Streaming, RTMP, Direct HTTP.
- Support for SMPTE 2022 FEC on Ethernet.
- Support for RIST on Ethernet.
- Closed-Captioning support (both EIA-608 and EIA-708 captions).
- AFD extraction and insertion support.
- Support for generic ancillary data transport using SMPTE-2038.
- Audio Encoding support: MPEG-1 Layer II and AAC-LC.
- Support for pre-compressed Dolby AC-3 pass-through embedded in SDI inputs.
- Support for SCTE-104 to SCTE 35 conversion.
- Support for secondary audio.
- Multiplexing support: each output can be configured to carry either encoder as a Single Program Transport Stream (SPTS), or both encoders as a Multi Program Transport Stream (MPTS).

## ***Product Overview***

The 9223-ENC supports up to two H.264 SD/HD encoders. The encoded transport stream can be routed and replicated to Ethernet and ASI outputs. Both SPTS and MPTS outputs are supported. The BBG-1123-ENC and the 9223-SA provide a compact form-factor standalone unit

---

for distribution MPEG-4 encoding. Utilizing the openGear® open-architecture control/monitoring platform, the 9223-ENC can be remotely controlled and monitored with the free, easy-to-use DashBoard™ setup and control operator interface.

The following inputs are available:

- Software-configurable Composite or SDI video inputs
- SDI video inputs support SD-SDI, HD-SDI and 3G-SDI
- Analog audio stereo inputs
- SDI embedded audio support
- Two internal test packet generators (which can be used to generate ASI or IP test streams)

The following outputs are available:

- Two ASI outputs
- Two Ethernet outputs, supporting full-duplex 100 Mb/s and 1 Gb/s operation

Each of the encoder channels in the BBG-1123-ENC can operate in one of two modes:

- **ASI/IP Streaming:** used in traditional broadcast applications. The encoded bitstream be transmitted over ASI or IP using UDP/RTP protocols, with replication capability.
- **OTT Protocols:** used for Internet streaming. These include RTMP, HLS, RIST and Direct HTTP. In the BBG-1123-ENC and the 9223-SA, the control port can be used for stream output in these modes.

## ASI/IP Streaming

For ASI/IP streaming, configuring the 9223-ENC includes the following steps:

**Step 1:** Setup the 9223-ENC to connect to remote control network using DashBoard.

**Step 2:** Configure the encoders.

**Step 3:** Configure the outputs (ASI or IP).

**Step 4:** Make connections between inputs and outputs.

The connections between inputs and outputs can be made as part of the input or output configuration steps. The 9223-ENC supports many-to-many connections.

The overall architecture is depicted below (dual-channel shown).

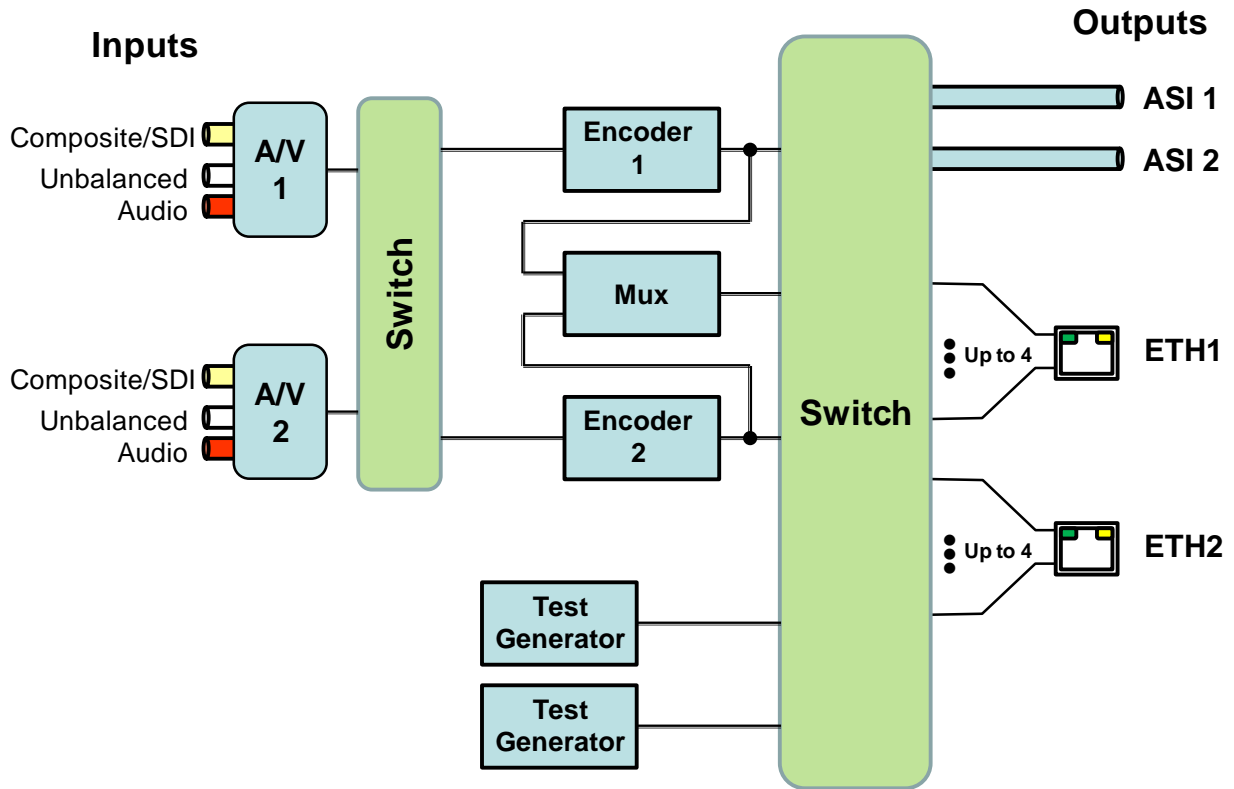

For the remainder of this manual, the term *port* for a physical input/output port (such as ASI or Ethernet), and *stream* for a transport stream present in the port. ASI ports support only one stream, while Ethernet ports support multiple streams.

### OTT and RIST Protocols

For OTT and RIST Protocols, all the configuration steps happen at the encoder – there is no connection phase. The overall architecture in OTT/RIST mode is depicted below.

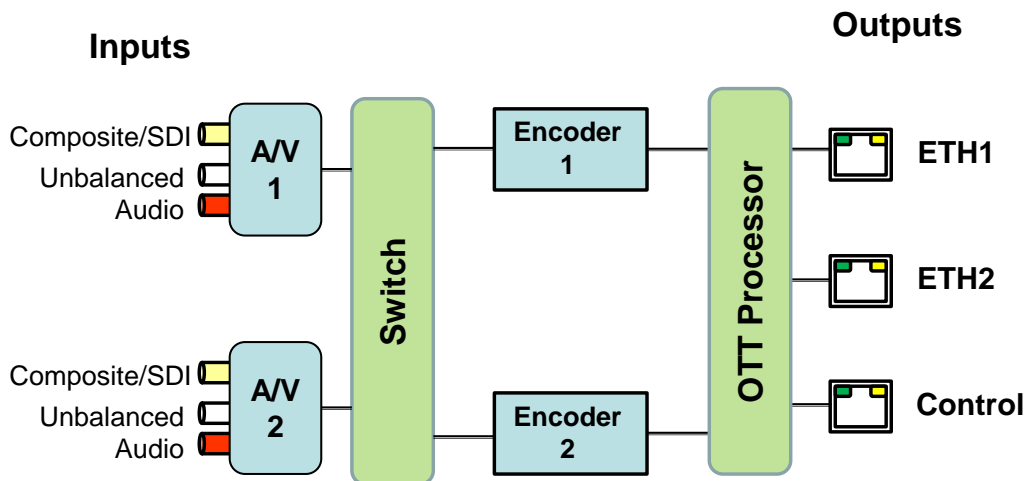

---

## Connecting BBG-1123-ENC to DashBoard Network Remote Control

**Note:** The BBG-1123-ENC is functional with all DashBoard versions, however GUI display response is optimized using version 5.0 or later. Prior DashBoard versions may result in GUI pages taking more time to update.

1. The first step is to install the Dashboard software on one or more control computers. Dashboard is available for Windows, Linux, and Mac OSX.
2. Connect the PC/Mac running Dashboard and the BBG-1123 device to the same network. For simplicity, even running an Ethernet cable between the two devices will work. The BBG-1123-ENC has auto-crossover capabilities, so any Ethernet cable will work. Connect the cable to a control port on the BBG-1123-ENC, as illustrated below:

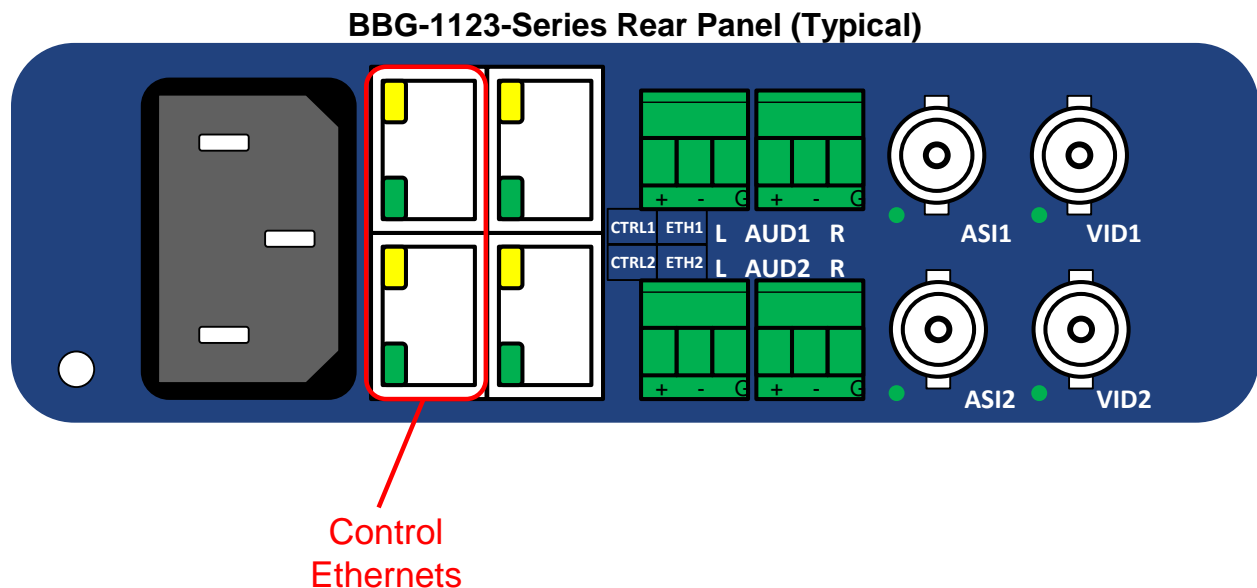

3. Using the front panel on the BBG-1123-ENC, change its control port IP address to be in the same subnet as the IP address of the computer running Dashboard. BBG-1123-ENC is shipped with a factory-default IP address of **192.168.1.30**. The procedure to change the IP address using the front panel is as follows:
  - a. Press the **Config** button.
  - b. Use the blue down button on the right side of the panel to select the **Network** entry. Press the round green button to select.
  - c. Select the **Change Config** option.
  - d. Select the **Control Port** option.
  - e. Follow the prompts to change the IP address, subnet mask and default gateway. You can also configure BBG-1123-ENC to use DHCP.

- The Dashboard application should automatically find the BBG-1123-ENC device and display it in the tree view on the left. If the device is not automatically found, click on the re-query button at the top of the Dashboard tree view, as indicated below. When found, BBG-1123-ENC will be identified as **Standalone Encoder**.

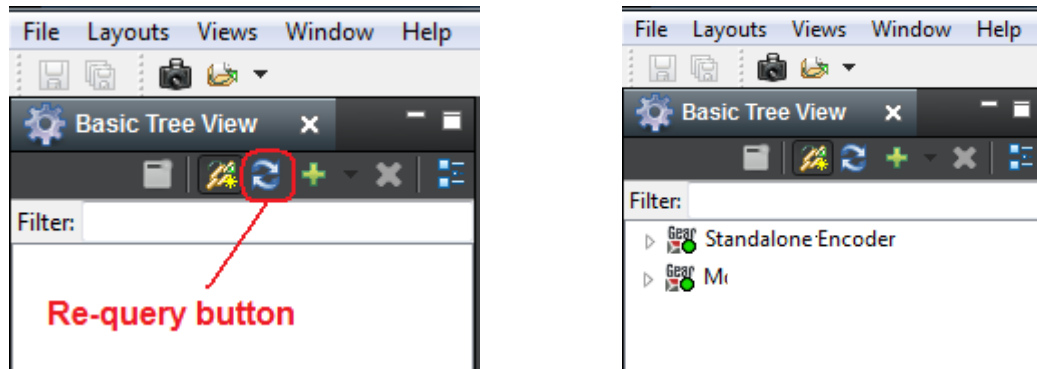

- In the unlikely case that the BBG-1123-ENC device is not automatically found by Dashboard, you can force a manual connection. Select **File** → **New** → **TCP/IP openGear Frame**, enter the IP address of BBG-1123-ENC device, and click on **Finish**:

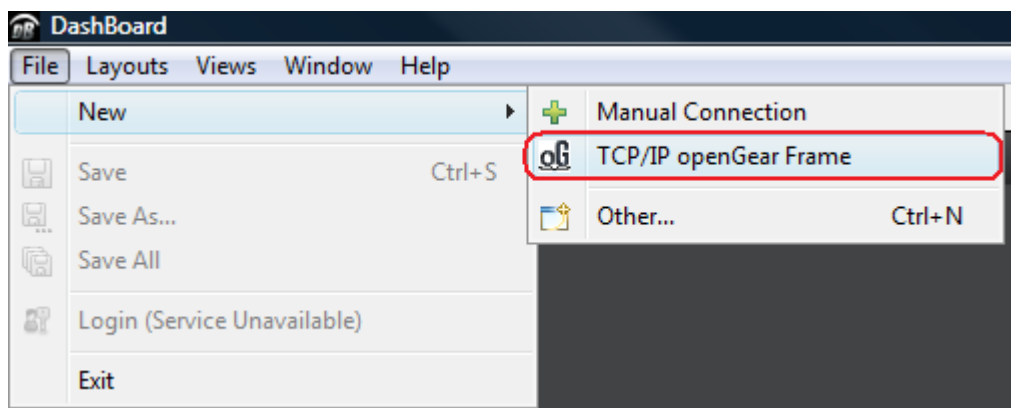

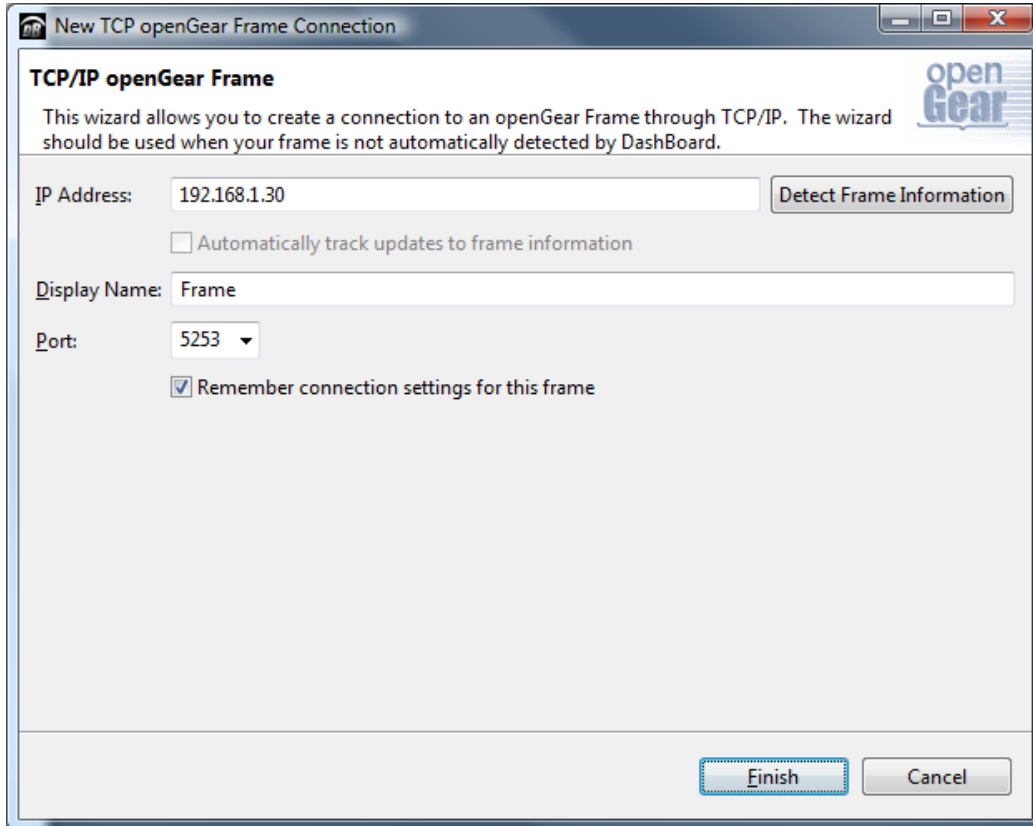

6. When the BBG-1123-ENC is available on Dashboard, open its user interface (by double-clicking on **Standalone Encoder** to open it, and then on the device name that appears in slot 0). You can now use DashBoard to further configure the device.
7. The two control ports in the BBG-1123-ENC are intended for redundancy. You can connect either one of them (or both) to your control network. The device will use whatever port is connected to respond to control operations.



---

## Connecting 9223-SA to DashBoard Network Remote Control

**Note:** The 9223-SA is functional with all DashBoard versions, however GUI display response is optimized using version 5.0 or later. Prior DashBoard versions may result in GUI pages taking more time to update.

DashBoard™ allows openGear® frames and their cards to be remote-controlled using a PC or Mac via a standard Ethernet connection. The DashBoard™ software can be downloaded from the <http://www.openGear.tv> website. When connected to your network, the 9223-SA appears in DashBoard just like any other device (similar to a frame).

1. Install the DashBoard software as described above. DashBoard is available for Windows, Linux, and Mac OSX.
2. By default, the 9223-SA is configured with a factory IP address of **192.168.1.30** or **192.168.1.50** and a subnet mask of **255.255.255.0**. In order to perform the initial configuration, you will need to configure the PC/Mac running DashBoard for an IP address in the same network. We suggest you use **192.168.1.0**. Once you gain access to the 9223-SA, you can reconfigure its IP address to whatever value you require, or configure it to run DHCP.
3. Connect the PC/Mac running DashBoard and the 9223-SA to the same network. For simplicity, even running an Ethernet cable between the two devices will work. The 9223-SA has auto-crossover capabilities, so any Ethernet cable will work. Connect the cable to either one of the **Control/Monitor** ports in the 9223-SA, as illustrated below:

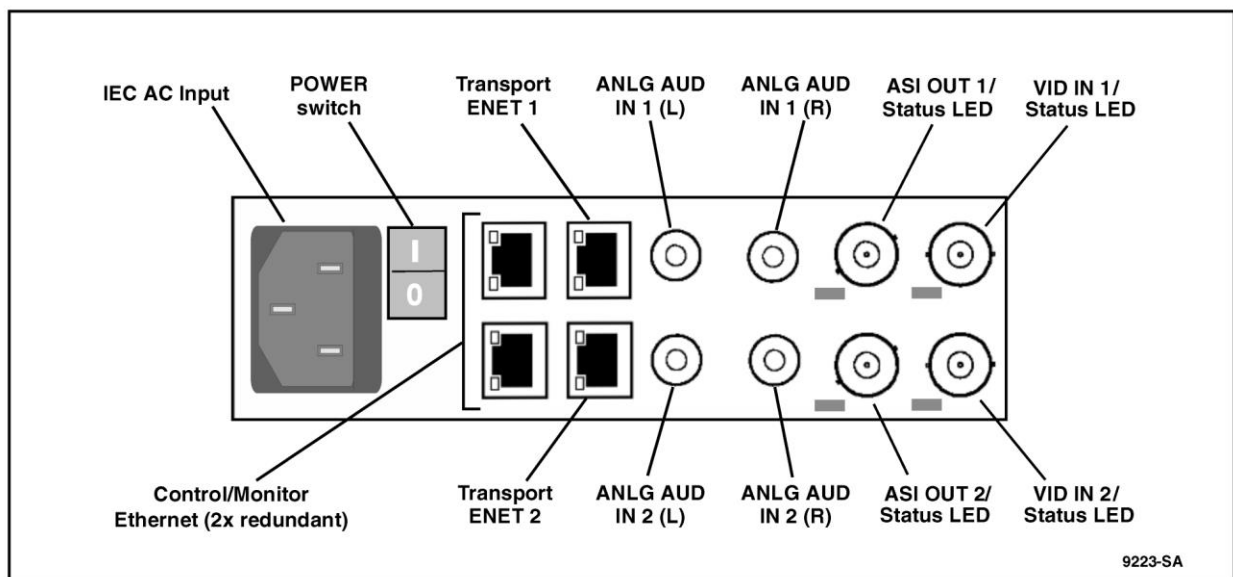

4. The DashBoard application should automatically find the 9223-SA and display it in the tree view on the left. If the 9223-SA is not automatically found, click on the re-query button at the top of the DashBoard tree view, as shown below:

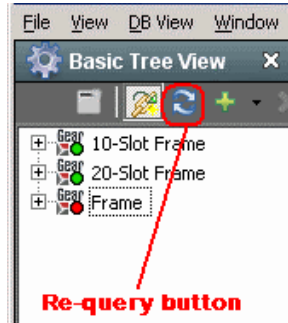

When the 9223-SA is found by DashBoard, it is identified as **Standalone Encoder**:

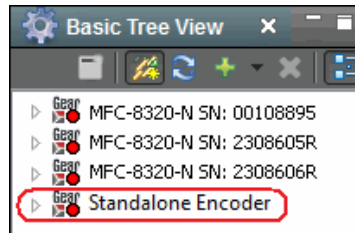

5. In the unlikely case that the 9223-SA is not automatically found by DashBoard, you can force a manual connection. Select **File** → **New** → **TCP/IP openGear Frame**, enter the IP address of the 9223-SA, and click on **Finish**:

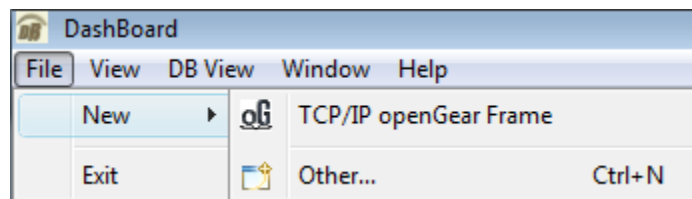

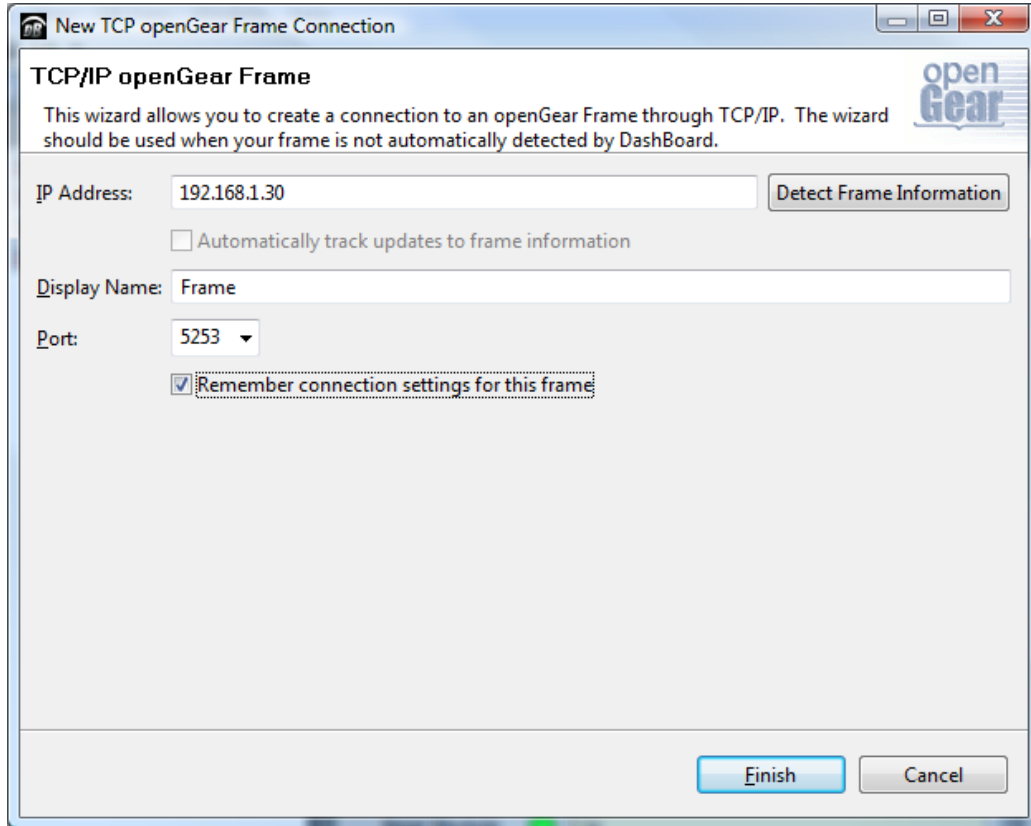

6. When the 9223-SA is available on DashBoard, open its user interface (by double-clicking on **Standalone Encoder** to open it, and then on the device in slot 0). Go to the **Control** tab on the right; you can now configure the IP address of the 9223-SA as desired. You can also rename the device if you wish.

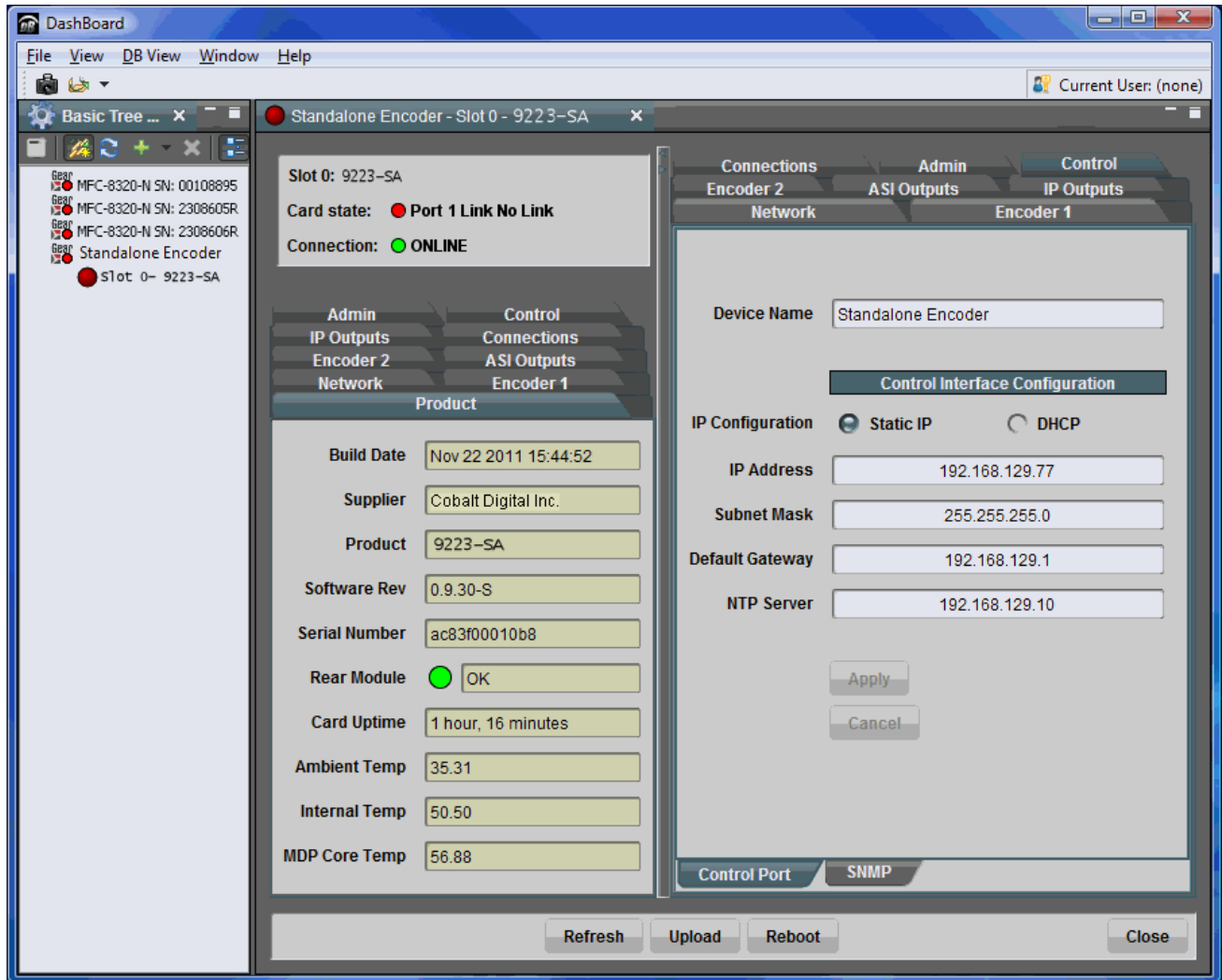

- The two control ports in the 9223-SA are intended for redundancy. You can connect either one of them (or both) to your control network. The 9223-SA will use whatever port is connected to respond to control operations.

---

## BBG-1123-ENC Indicators and Switches

The BBG-1123-ENC can be used as a desktop encoder, or in a 19" rack-mount tray that holds up to three units:



### ***Back Panel***

The BBG-1123-ENC ships with one of two possible back panels:

- Unbalanced Audio Back Panel
- Balanced Audio Back Panel

The panels are depicted in the next page.

Both panels include two software-configurable Composite/SDI video inputs on standard BNC connectors, two ASI output ports on standard BNC connectors, two streaming 100/1000 Mb/s Ethernet ports on standard RJ-45 connectors, and two control 10/100/1000 Mb/s Ethernet ports on standard RJ-45 connectors, in addition to the analog audio connectors. In the unbalanced version, the analog audio connectors are standard RCA jacks; in the balanced audio version, the analog audio connectors are terminal blocks.

### Unbalanced Audio Version

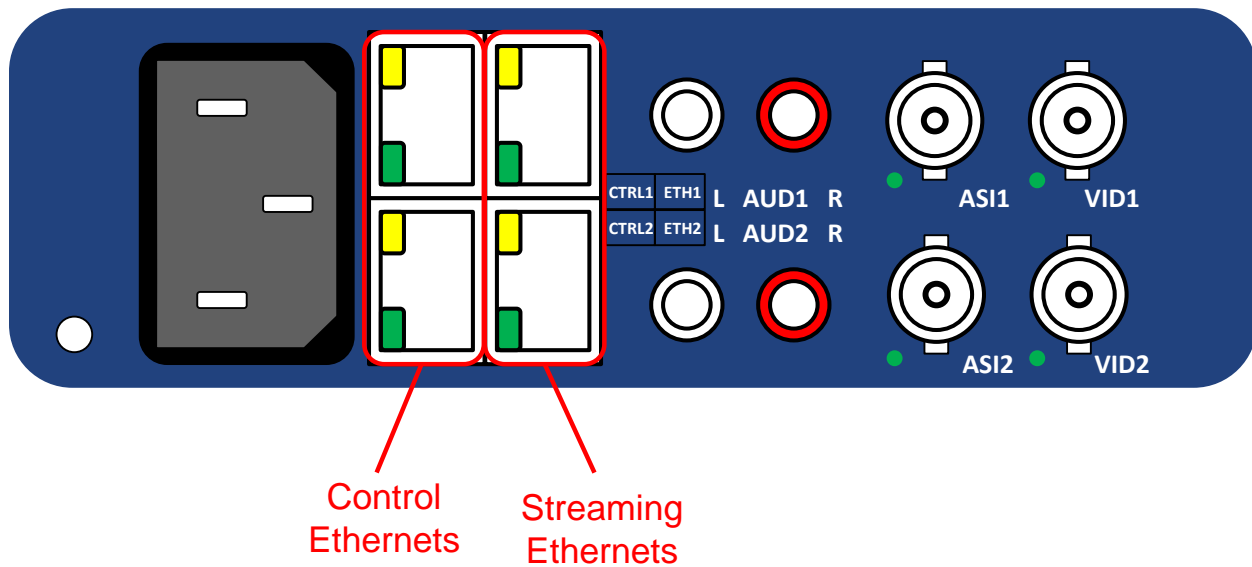

### Balanced Audio Version

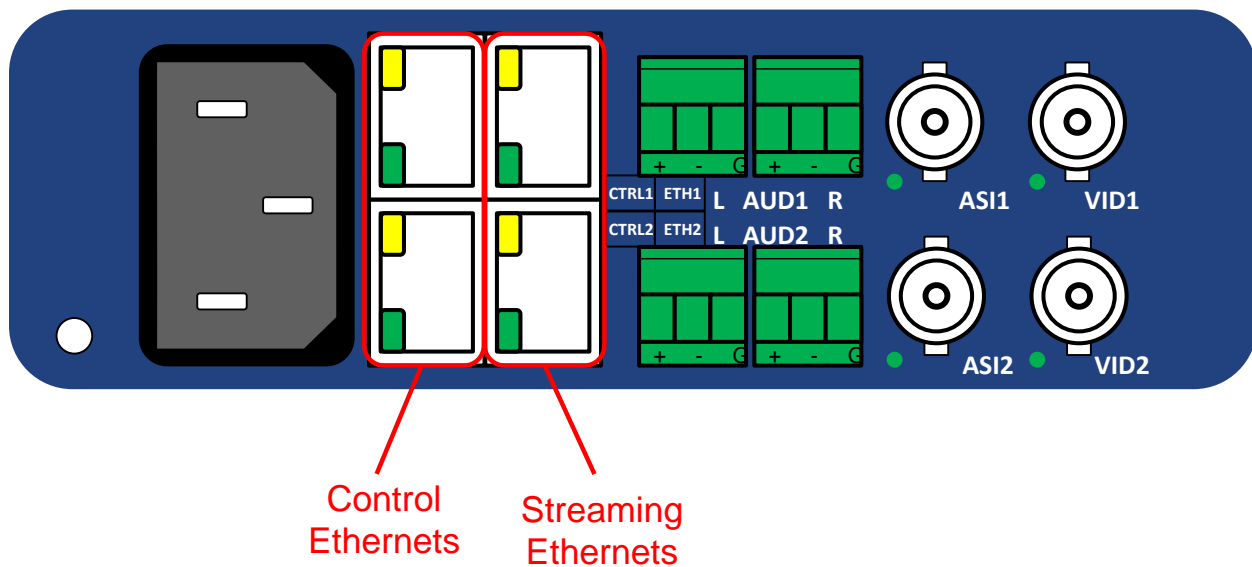

Each of the video inputs has a green indicator LED, with the following states:

- **LED off:** no video signal detected, or input not configured.
- **LED flashing:** video input locked to the video signal.
  - **LED flashing about once per second:** input video is SD.
  - **LED flashing about twice per second:** input video is HD-SDI.
  - **LED flashing about 4 times per second:** input video is 3G-SDI (1080p60).

---

Each of the ASI output ports has a green indicator LED, with the following states:

- **LED off:** ASI output port is disabled.
- **LED flashing:** ASI output port is configured and enabled.

Each of the Gigabit Ethernet ports has two indicator LEDs, with the following states:

- **Green LED:**
  - **Off:** No link
  - **On:** Link
- **Yellow LED:**
  - **Off:** No activity (transmit and/or receive)
  - **Flashing:** Port is currently transmitting and/or receiving

### ***Front Panel Indicators***

The BBG-1123-ENC has a front panel with an LCD display and buttons:



Operation of the panel is as follows:

- The device powers up as soon as the power cable is connected to power. In order to turn off the power, press and hold the power button on the left. The button will flash red for about 3 seconds, and after that power turns off.
- By default, the LCD screen shows the following information:
  - **Device Model:** BBG-1123-ENC
  - **Device Name:** User-assigned name, configured through DashBoard in the **Error! eference source not found..**
  - **Control Port IP Address:** Current IP address assigned to the control port.

An example is depicted below:

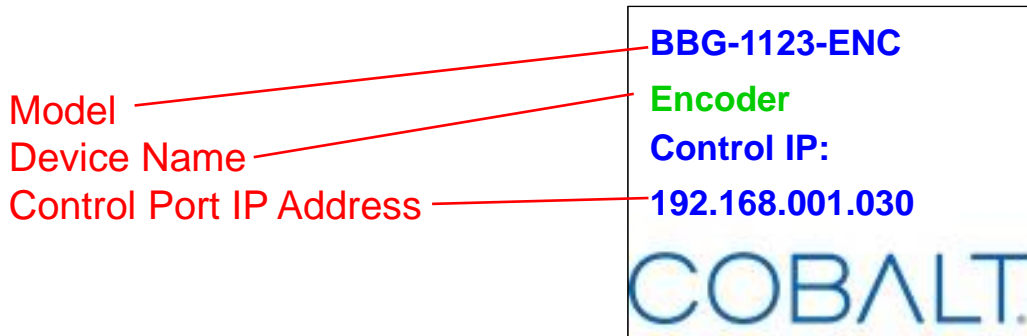

- The LCD automatically turns off after 1 minute of inactivity. It turns back on as soon as any key in the front panel is pressed.
- Three function buttons to the left of the LCD screen, marked as **Presets**, **Config** and **Status**. These buttons can light up either green or red. Their functions are:
  - **Presets** button: brings up the 5 presets defined and allows one of them to be selected and applied to the device.
  - **Config** button: allows for some more common items to be configured.
  - **Status** button: allows for quickly inspecting the status and alarms in the device.
- Navigation buttons to the right of the LCD screen. The center (green) button is the **Enter** button, used to accept selections. There are 4 blue buttons to navigate menus (up, down, left, right).

## The Presets Menu

The BBG-1123-ENC has the ability to save up to 5 configurations (presets). The **Presets** front panel key brings up a menu to select any of the presets. Use the Up/Down (blue) keys to select the desired preset, and the Enter (green) key or the right (blue) key to select it. Use the left key to exit the menu (or press one of the other function buttons).

Here is an example of the presets screen:

**PRESETS:**  
 >1: Satellite Transmis  
 2: Microwave Link  
 3: IPTV Configuration  
 4: Internet Streaming  
 5: (empty)

Config	Status	Name
1	Saved	Satellite Transmission
2	Saved	Microwave Link
3	Saved	IPTV Configuration
4	Saved	Internet Streaming
5	Empty	



## The Config Menu

The **Config** front panel key bring up the configuration menu tree. Only a few selected parameters can be configured in this menu; these are the most common configuration parameters. The Config menu tree is displayed below.

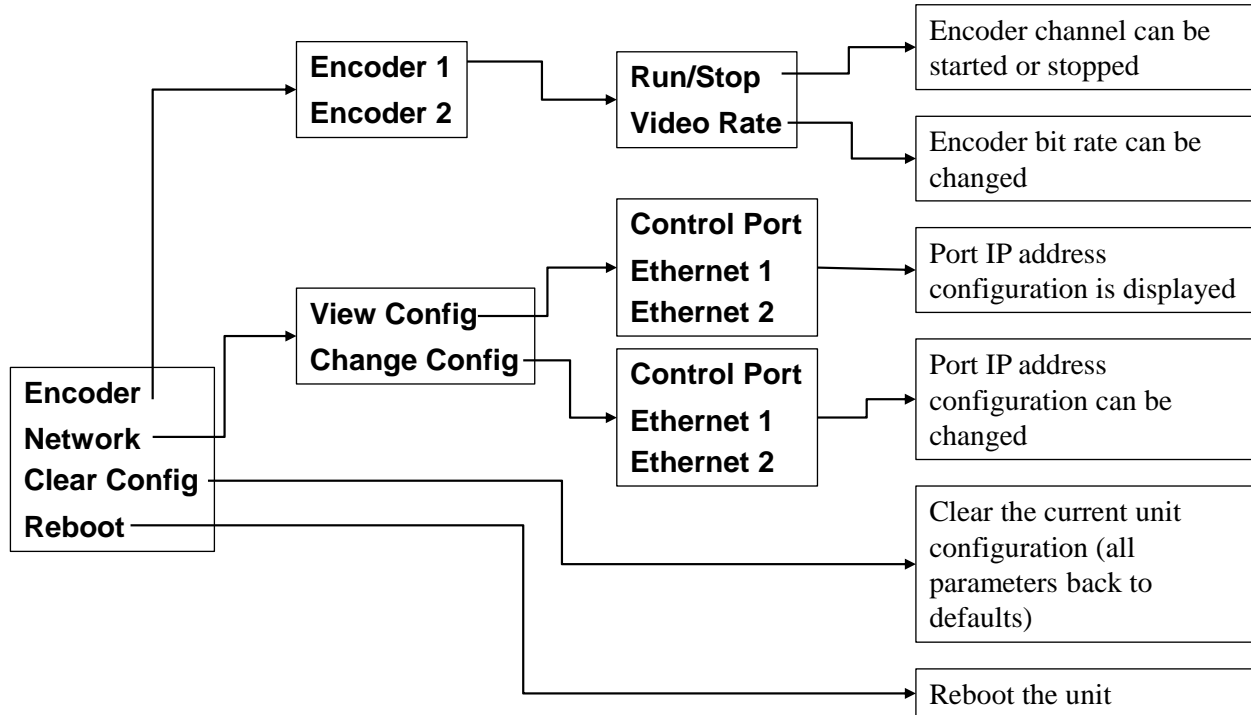

## The Status Menu

The **Status** button will be lighted steady green if there are no active alarms, or flashing red if there are active alarms. Pressing the **Status** button will bring up the status menu tree, depicted below:

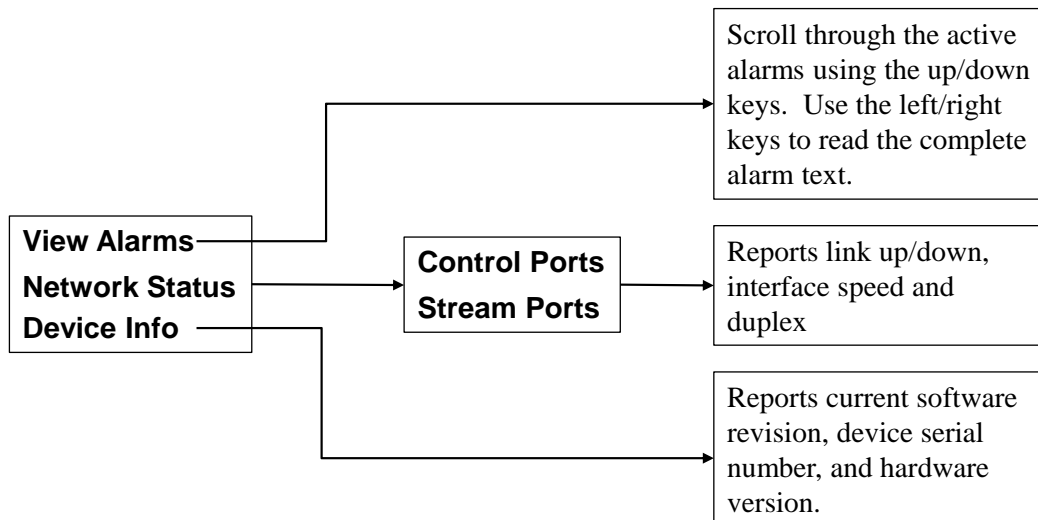

---

## Factory Configuration Reset

It is possible to reset the configuration of the BBG-1123-ENC to the factory default. This can be used as a “last resort” in case of a configuration error. The steps are as follows:

- Power off the unit by pressing and holding the Power button for 3 seconds or more.
- Power on the unit again.
- Watch the front panel and left-side buttons. They will go through the following steps:
  1. The buttons will light up and the company logo will be displayed.
  2. The button lights turn off.
  3. The company logo disappears, replaced by a black screen.
  4. The company logo appears.
- When the panel gets to step 4, press and hold the **Config** button. Keep holding the button until you see the message **Config Clear** at the bottom of the screen.

---

## 9223-SA Indicators and Switches

The 9223-SA can be used as a desktop encoder, or in a 19" rack-mount tray that holds up to three units:



### ***Back Panel***

The 9223-SA ships with one of two possible back panels:

- Unbalanced Audio Back Panel
- Balanced Audio Back Panel

The panels are depicted in the next page.

Both panels include two software-configurable Composite/SDI video inputs on standard BNC connectors, two streaming 100/1000 Mb/s Ethernet ports on standard RJ-45 connectors, and two control 10/100/1000 Mb/s Ethernet ports on standard RJ-45 connectors, in addition to the analog audio connectors. In the unbalanced version (9223-SA ... -U), the analog audio connectors are standard RCA jacks; in the balanced audio version (9223-SA ... -B), the analog audio connectors are terminal blocks.

## Unbalanced Audio Version (-U part number suffix)

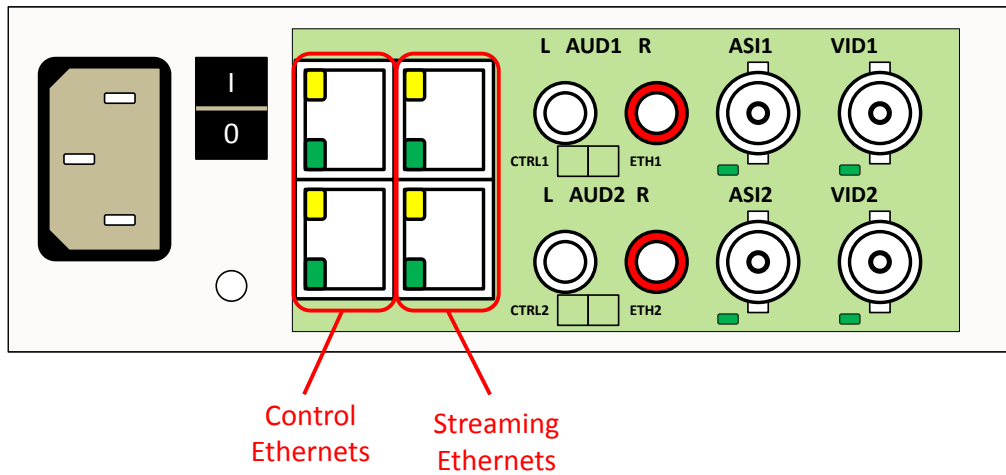

## Balanced Audio Version (-B part number suffix)

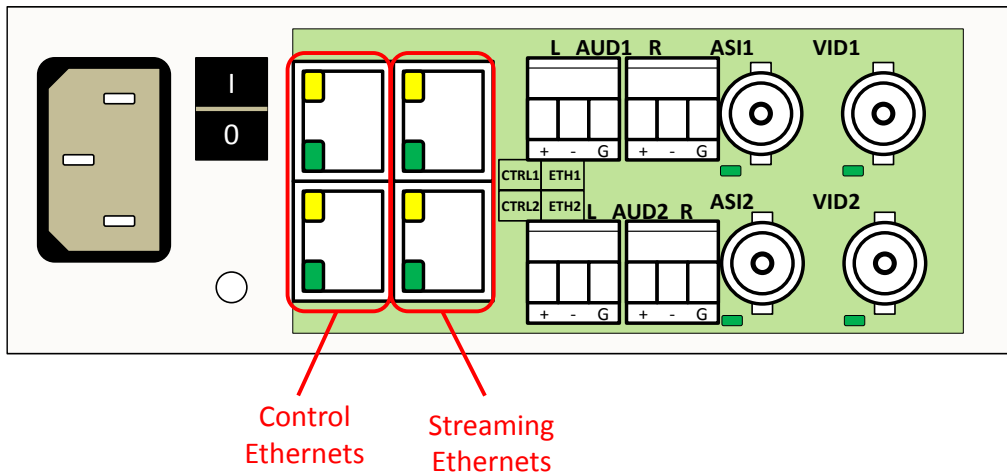

Each of the video inputs has a green indicator LED, with the following states:

- **LED off:** no video signal detected, or input not configured.
- **LED flashing:** video input locked to the video signal.
  - **LED flashing about once per second:** input video is SD.
  - **LED flashing about twice per second:** input video is HD-SDI.
  - **LED flashing about 4 times per second:** input video is 3G-SDI (1080p60).

Each of the ASI output ports has a green indicator LED, with the following states:

- **LED off:** ASI output port is disabled.

- **LED flashing:** ASI output port is configured and enabled.

Each of the Gigabit Ethernet ports has two indicator LEDs, with the following states:

- **Green LED:**
  - **Off:** No link
  - **On:** Link
- **Yellow LED:**
  - **Off:** No activity (transmit and/or receive)
  - **Flashing:** Port is currently transmitting and/or receiving

### Front Panel Indicators

A similar set of indicators exist in the front panel of the unit. The layout is depicted below.

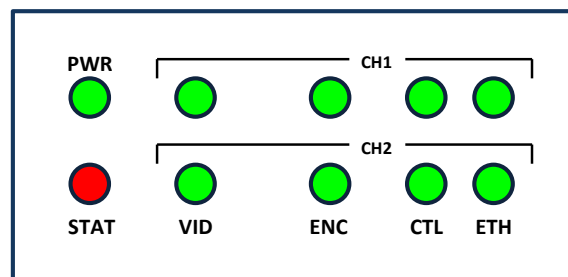

The front panel LED indicators are as follows:

- **STAT:** indicates the overall status of the unit.
  - **Green:** no active alarm
  - **Red:** at least one critical alarm present

When powering up the unit, this LED will be red until the board starts operation. At that point, it will turn green if there is no active alarm or stay red if there is at least one alarm.
- **PWR:** indicates that the power is OK.
  - **Green:** power OK
  - **Off:** no power or insufficient voltage
- **CH1/CH2 VID:** these behave exactly the same as the corresponding back panel video input indicators.
- **CH1/CH2 ENC:** these LEDs flash if the corresponding encoder is running, with output available for routing to ASI, UDP or RTP. They will not flash if the encoder is stopped (either by explicit configuration or by lack of input) or if it is in one of the Web streaming modes (HTTP Live Streaming or Direct HTTP Streaming).
- **CH1/CH2 ETH and CTL:** these indicate the status of the corresponding Ethernet connection.
  - **Off:** no link
  - **On:** link OK, no activity
  - **Blinking:** link OK, port is transmitting and/or receiving packets

---

## Front Panel Default Switch

The front panel has a recessed switch that can be used to restore the unit to its defaults. Use a pen or a small screwdriver to press this switch.



If the switch is pressed during normal operation, the control port IP address, mask and gateway are restored to the following factory default settings:

- IP Address: 192.168.1.30
- Subnet Mask: 255.255.255.0
- Gateway: 192.168.1.1

The **STAT** front panel indicator will change colors for about 3 seconds to acknowledge the change. Note that this operation **does not** disturb the encoding function or the streaming Ethernet ports (i.e., it is not service-affecting). The IP addresses of the streaming ports may be also automatically changed if they are in the same subnet as the control IP address above.

If you press and hold this switch when the unit is powered off, and then power up the unit while holding the switch, the following actions will be performed:

- The control IP address, mask and gateway are reset to the factory defaults as described above.
- The unit configuration is cleared.
- The unit reverts to the factory-installed firmware.

As before, the **STAT** LED will temporarily change color to acknowledge the command. When it changes color, you can release the switch. You can use this feature in the unlikely event of a corrupted firmware upgrade or a corrupted configuration.

---

## 9223 Indicators and Switches

The 9223 card can be installed in 20-slot openGear-compatible frames. Prior to installing the card, first install the corresponding rear panel I/O module.

### ***Rear I/O Panel Indicators***

There are two rear I/O panels available for the 9223 encoder, to support different analog audio inputs:

- Unbalanced Audio I/O Panel
- Balanced Audio I/O Panel

All 9223 I/O panels have two software-configurable Composite/SDI video inputs on standard BNC connectors and two 100/1000 Mb/s Ethernet ports on standard RJ-45 connectors. There are also two unused BNC ports. The unbalanced audio I/O panel includes four RCA connectors, and the balanced audio I/O panel includes four terminal blocks. The panels are depicted in the next page.

Each of the video inputs has a green indicator LED, with the following states:

- **LED off:** no video signal detected, or input not configured.
- **LED flashing:** video input locked to the video signal.
  - **LED flashing about once per second:** input video is SD.
  - **LED flashing about twice per second:** input video is HD-SDI.
  - **LED flashing about 4 times per second:** input video is 3G-SDI (1080p60).

Each of the ASI output ports has a green indicator LED, with the following states:

- **LED off:** ASI output port is disabled.
- **LED flashing:** ASI output port is configured and enabled.

Each of the Gigabit Ethernet ports has two indicator LEDs, with the following states:

- **Green LED:**
  - **Off:** No link
  - **On:** Link
- **Yellow LED:**
  - **Off:** No activity (transmit and/or receive)
  - **Flashing:** Port is currently transmitting and/or receiving

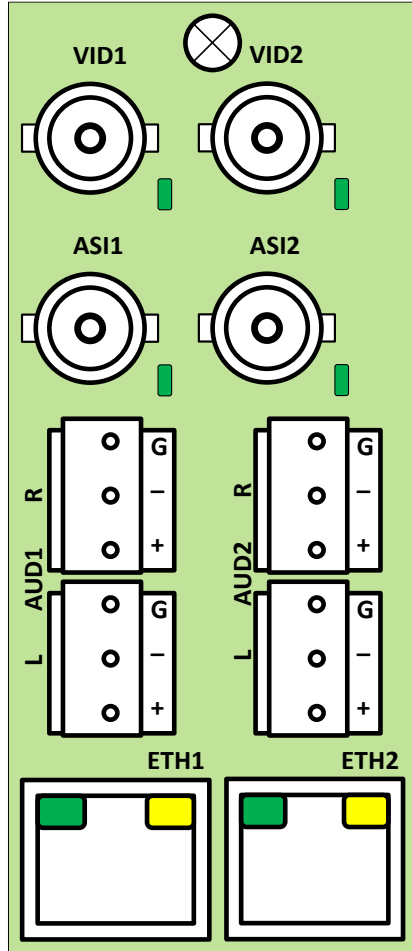

Balanced Audio

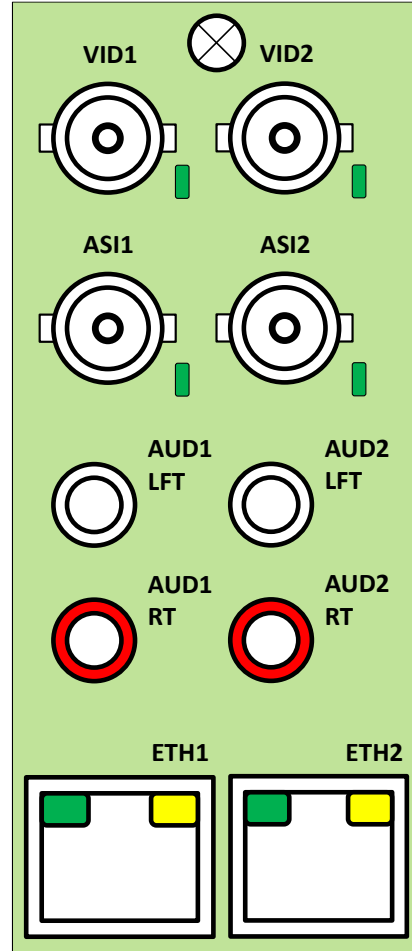

Unbalanced Audio

Note that the balanced audio rear I/O panel is only supported boards with hardware version 4 and higher. The hardware version is available in the Product Tab in Dashboard.

### Front Indicators

A similar set of indicators exist in the front of the board. These are visible when the frame front door is opened. The indicator layout is depicted below.

The LED indicators are as follows:

- **Status LED:** indicates the overall status of the board.
  - **Green:** no active alarm
  - **Red:** at least one critical alarm present
 When inserting a board in the frame, this LED will be red until the board starts operation. At that point, it will turn green if there is no active alarm or stay red if there is at least one alarm.
- **Power OK LED:** indicates that the power received from the frame is OK.
  - **Green:** power OK



- **Off:** no power (or insufficient voltage – check the frame power status)
- **VID 1 and VID 2 LEDs:** these behave exactly the same as the corresponding rear I/O panel indicators.
- **ASI 1 and ASI 2 LEDs:** these behave exactly the same as the corresponding rear I/O panel indicators.
- **ENC1 and ENC2 LEDs:** these LEDs flash if the corresponding encoder is running, with output available for routing to ASI, UDP or RTP. They will not flash if the encoder is stopped (either by explicit configuration or by lack of input) or if it is in one of the Web streaming modes (HTTP Live Streaming or Direct HTTP Streaming).
- **ETH1 and ETH2 LEDs:** these indicate the status of the corresponding Ethernet connection.
  - **Off:** no link
  - **On:** link OK, no activity
  - **Blinking:** link OK, port is transmitting and/or receiving packets

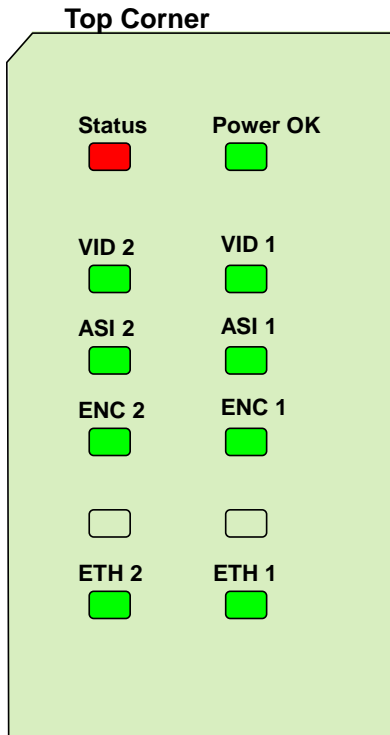

The 9223 board has other LEDs that may or may not be illuminated. They are intended for engineering debug only.

### **Front Switches**

The 9223 board has two pushbutton-type switches in the front, just below the LEDs, as depicted below. Their operation is as follows:

- 
- **Default IP Switch:** This switch is used to recover the board in the unlikely case of a corrupted or broken firmware update. In most cases, the 9223 will detect the error and automatically fall back into the factory-default firmware load. If it does not, pull the card out, press and hold this switch, and push the card back into the frame while still holding the switch. You can release the switch once the Status LED turns orange. This action causes the card to revert to the factory-default firmware.
  - **Reset Switch:** Pressing this pushbutton switch causes the card to reset.

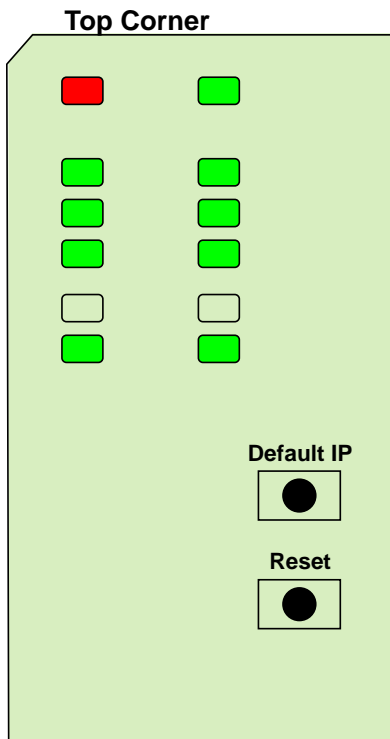

---

## 9223-ENC Operation and Management

The 9223-ENC is configured using the free DashBoard™ application, which is available for Windows, Apple OS X, and Linux.

The 9223-ENC user interface is depicted below. As with any openGear™ device, it is divided into a statistics panel on the left, and a configuration panel on the right. Each panel has multiple tabs, corresponding to the various functions of the unit. Note that the **Card State** (device state) alarm indicator is also reflected in the green/red **STAT** LED on the front panel. The **STAT** LED will be green when Card State is green or yellow, and will be red when Card State is red.



The following tabs are available:

- **Product:** this tab provides general information for the unit, including firmware version, uptime, temperatures, and other parameters. It appears only on the Statistics panel.
- **Network:** this tab is used to configure the IP addresses and network information for the **transport** Ethernet ports. The statistics side of the panel includes some additional information such as link state.
- **Encoder 1, Encoder 2:** these tabs are used to configure the two encoder channels.
- **ASI Outputs:** this tab is used to configure/monitor the ASI ports.
- **IP Outputs:** this tab is used to configure/monitor the IP Output ports. The configuration panel provides the facilities to create, manage and delete ports; the statistics panel includes transmission status information.
- **Connections:** this tab is used to configure/monitor connections. The configuration panel provides facilities to create, edit and delete connections; the statistics panel provides a table where the status of all the connections in the unit can be inspected at a glance.
- **Admin:** this tab is used for general administrative functions, such as firmware upgrades, licensing, logs, and configuration management. The Test Packet Generator configuration is also found under this tab.
- **Control:** this tab is used to configure/monitor the control ports and the SNMP functions of the device. It is available only for the BBG-1123-ENC and 9223-SA models.



---

## Product Tab

The Product Tab contains basic information about the 9223-ENC.

<b>Build Date</b>	Jul 20 2017 15:14:05
<b>Supplier</b>	Cobalt Digital Inc.
<b>Product</b>	BBG-1123-ENC-S-HD-P
<b>Software Rev</b>	2.6.11
<b>Serial Number</b>	ac83f0001114
<b>Hardware Version</b>	4
<b>Rear Module</b>	 OK
<b>Analog Audio Input</b>	Balanced
<b>Card Uptime</b>	1 minute
<b>Ambient Temp</b>	29.69
<b>Internal Temp</b>	41.00
<b>MDP Core Temp</b>	44.44
<b>PS1 Status</b>	 OK
<b>PS2 Status</b>	 OK

The following information is available:



- **Build Date:** Date the firmware image was built.
- **Supplier:** Cobalt Digital Inc.
- **Product:** This indicates the actual product.
- **Software Rev:** This indicates the firmware revision currently running. The format is Major Version • Minor Version • Build Number.
- **Serial Number:** This is the serial number of this particular 9223-ENC.
- **Hardware Version:** This indicates the version of the encoder hardware.
- **Rear Module:** This indicates the status of the Rear I/O Module. It can have one of the following states:
  -  **OK:** The Rear Module is the correct module for the MVN-EN460. In the ITV-EN460c/d this indicator will be always green.
  -  **Not Installed:** The MVN-EN460 is not connected to a rear module. The card is operating normally, but it will not be useful as there are no input and output connections to it.
  -  **Wrong Module:** The MVN-EN460 is connected to a rear module that was not designed for it (most likely from another openGear® vendor). Depending on the signals present on that module, there may be a small chance of damage to the

---

MVN-EN460; ImmediaTV recommends that this situation be rectified immediately. This alarm will cause the front status LED to turn red. A card with hardware version 3 or lower will show this alarm for the balanced audio rear I/O panel.

- **Card Uptime:** Indicates how long the unit has been running since it was last rebooted.
- **Analog Audio Input:** This indicates the type of analog audio input (balanced or unbalanced).
- **Ambient Temperature:** Temperature, in degrees Cesium, of the unit internal case ambient temperature.
- **Internal Temperature:** Temperature, in degrees Cesium, adjacent to the unit PCB rear.
- **MDP Core Temperature:** Temperature, in degrees Cesium, of the core processing element.

The BBG-1123-ENC has two internal redundant power supplies. Each power supply is capable of individually powering up the device. The **PS1 Status** and **PS2 Status** indicate the status of each of the internal power supplies, as follows:

-  **OK:** The power supply is working normally.
-  **No Power:** The power supply has failed and is not providing power. Contact Cobalt Digital to get the unit repaired.

The 9223-ENC is designed to operate in environments with an ambient temperature between 0 and 50 °C.

---

## Network Tab

The Network Tab allows for configuration/monitoring of the two streaming Ethernet ports, and optional configuration of DNS servers.

### Network Configuration Tab

The Network Configuration Tab is used to set the individual parameters for each of the Ethernet ports.

- The **Interfaces** tab is used to set the individual parameters for each of the streaming Ethernet ports.
- The **DNS** tab is used to optionally configure DNS servers.
- The **RIST Tunnels** tab is used to manage RIST Main Profile tunnels.

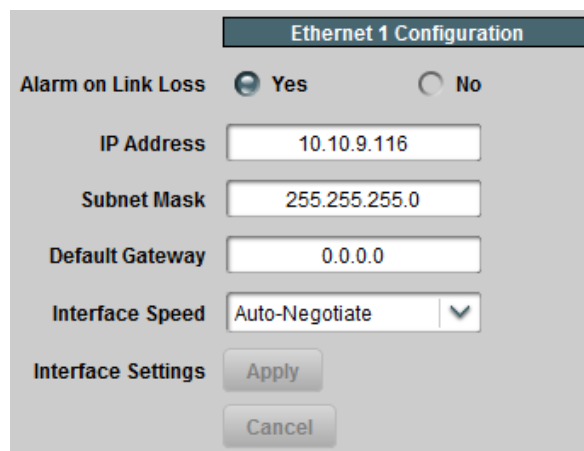

## Configuration Tabs

### Network Configuration Interfaces Tab

The following parameters can be configured:

- **Alarm on Link Loss:** If set to Yes, the unit will raise an alarm if this Ethernet interface loses link. The Card State indicator in DashBoard™ and the front panel **STAT** LED will both be red. If set to No, the unit will still report loss of link in the Statistics page but no alarm will be raised. It is recommended that the alarm for ports that are in use be turned on; only turn it off if you do not plan to connect that port to a network.
- **IP Address:** Enter the desired IP address for this Ethernet port.
- **Subnet Mask:** Enter the desired subnet mask for this Ethernet port.
- **Default Gateway:** Enter the desired default gateway for this Ethernet port, or 0.0.0.0 if no gateway is available.

- **Interface Settings:** If you make any changes to the IP Address, Subnet Mask and/or Default Encoder fields, the **Apply** and **Cancel** buttons become active. The changes only take effect when you press the **Apply** button. Pressing the **Cancel** button reverts the fields back to their original values. Note that the 9223-ENC will check the consistency of the data entered and will reject invalid combinations (i.e., combinations where the gateway is outside the interface subnet). Once the **Apply** button is pressed, a status message appears just below the **Cancel** button, as follows:

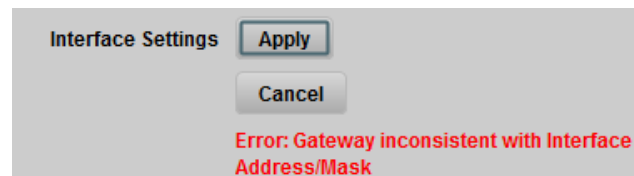
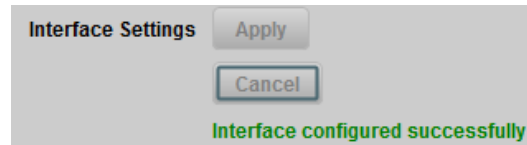

- **Interface speed:** Configures the speed of the interface. The 9223-ENC Ethernet interfaces only support two modes: 100 Mb/s Full-Duplex and 1 Gb/s Full-Duplex<sup>1</sup>.
  - **Auto-Negotiate:** The Ethernet port will auto-negotiate the speed.
  - **100 Mb/s Full-Duplex:** Force the port to 100Mb/s Full-Duplex mode. Note that the port will still perform auto-negotiation, but it will only advertise this mode.
  - **1Gb/s Full-Duplex:** restrict the operation to 1Gb/s Full-Duplex mode. Note that the port will still perform auto-negotiation, but it will only advertise this mode.

**Notes:**

- If the 9223-ENC streaming Ethernet interfaces are connected to a 10 Mb/s switch, hub, or network feed, link will **not** be established and the port will not recognize the connection.
- If you select **100 Mb/s Full-Duplex** or **1 Gb/s Full-Duplex** and the corresponding streaming Ethernet interface is connected to a switch, hub or network feed that does not support the selected speed, link will **not** be established and the port will not recognize the connection.
- If the interface speed is set to **Auto-Negotiate**, the streaming Ethernet port will allow link to be established in 100 Mb/s Half-Duplex mode. However, this will be flagged as a warning.

## Network Configuration DNS Tab

The DNS tab allows manual configuration of up to two DNS servers. They do not need to be in the same subnetwork as the streaming ports, as long as at least one default gateway is configured. DNS is only used in conjunction with the RTMP or HLS output functionality. If you are not using either protocol, there is no need to configure DNS servers.

<sup>1</sup> Support for 10 Mb/s and Half-Duplex modes has been discontinued, as these are unsuitable for MPEG transport over IP applications. Moreover, any modern switch supports at least 100 Mb/s Full-Duplex.

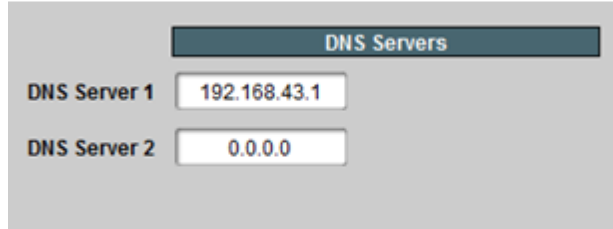

DNS server configuration takes effect immediately, as soon as the information is entered.

In the BBG-1123-ENC and 9223-SA encoders, it is also possible to configure DNS in the Control Port Configuration Tab. DNS Servers configured in the Control Tab have priority over servers configured here.

### Network Configuration RIST Tunnels Tab

This tab allows the creation and management of RIST Main Profile tunnels. The 9223-ENC supports the creation of up to 2 RIST Main Profile tunnels. Creation of RIST tunnels requires the +**RIST/ARQ-ENC** license. RIST Main Profile tunnels use the GRE over UDP protocol.

In order to create a tunnel, check the **Tunnel Enable** box below:



Once the box is checked, the tunnel parameters are shown:



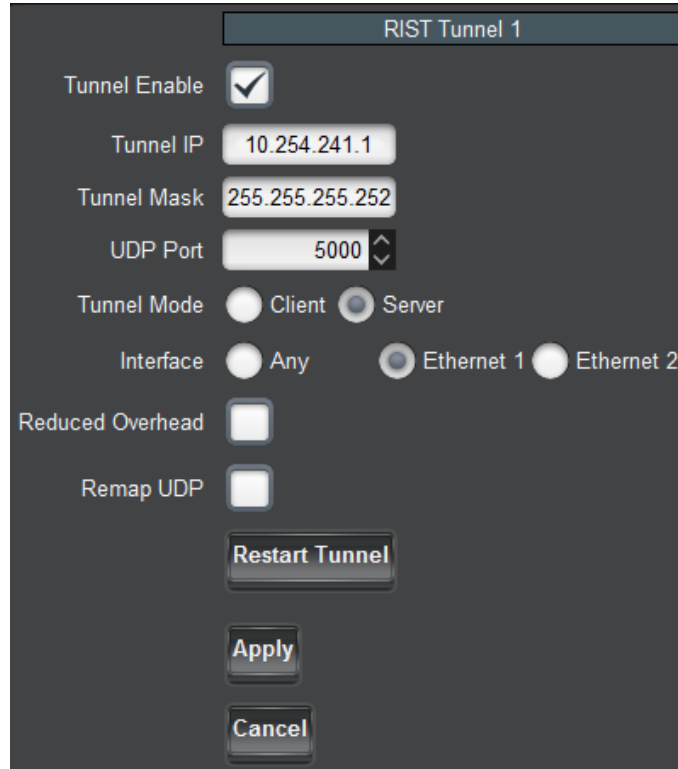

- **Tunnel IP:** this is the inner IP address of the encoder in the tunnel. It is not usually necessary to configure this parameter.
- **Tunnel Mask:** this is the subnet mask for the tunnel interface. It is not usually necessary to configure this parameter.
- **UDP Port:** this is the UDP port to be used in the tunnel establishment, as follows:
  - If the 9223-ENC is a **Server**, it will listen on this UDP port for incoming tunnel connections.
  - If the 9223-ENC is a **Client**, it will attempt to connect to this port in the server.
- **Tunnel Mode:** The 9223-ENC can be either a **Server** or a **Client**. If it is a server, it will wait to be contacted. If it is a client, it will actively attempt to contact the server. If **Client** is selected, an additional field appears where the server IP address can be entered:

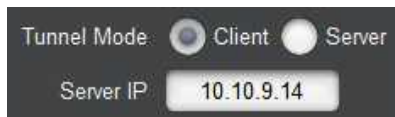

- **Interface:** selects the network interface to use for this communication. The value of **Any** allows the device to select the most convenient interface based on the IP address. In particular, if the 9223-ENC is configured as a server, it will accept incoming connections on both Ethernet ports if the interface is set to **Any**. The standalone models will also accept connections on their control port.
- **Reduced Overhead:** RIST Main Profile defines a Reduced Overhead mode where only a simplified header. This reduces the overhead from 2.4% to 0.6%. This checkbox enables

---

the use of Reduced Overhead mode for transmitted packets. Note that the 9223-ENC automatically detects incoming reduced overhead packets.

- **Remap UDP:** This box, if checked, causes the 9223-ENC to assume that all UDP packets coming in from the tunnel are destined to it regardless of their destination address. This control disappears in Reduced Overhead mode.
- Note that if the 9223-ENC is a server, it will be up to the peer to reconnect.
- **Apply/Cancel:** Each tunnel has independent Apply/Cancel buttons. Clicking on **Apply** causes the configuration changes to become active and persisted. Clicking on **Cancel** causes any changes to be discarded.

## Network Statistics Tab

The Network Statistics Tab reports the status of the various functions in the Network tab.

### Network Statistics Interfaces Tab

The Network Statistics Tab reports the current IP configuration of each **transport** Ethernet port, as well as their link state and running status.

The screenshot displays the 'Ethernet 1 Configuration' window with the following parameters:

Ethernet 1 Configuration	
Alarm on Link Loss	Yes
IP Address	10.10.9.116
Subnet Mask	255.255.255.0
Default Gateway	0.0.0.0
Interface Speed	Auto-Negotiate
Port 1 Link	Link OK
Port 1 Status	OK
Link Speed (Mb/s)	1000
MAC Address	ac:83:f0:00:10:1a

The following parameters are reported in the Network Statistics tab:

- **Alarm on Link Loss:** Reports the current setting of this parameter.
- **IP Address:** Reports the current IP Address for the port.
- **Subnet Mask:** Reports the current Subnet Mask for the port.
- **Default Gateway:** Reports the current Default Gateway for the port.
- **Interface Speed:** Reports the current setting for this parameter.
- **Port 1/2 Link:** This indicator has the following states:
  - **Link OK:** The port has established link with the network connection.
  - **Half-Duplex Link:** The port is set to **Auto-Negotiate**, and it has achieved 100 Mb/s Half-Duplex link with the network connection. We do not consider Half-

---

Duplex links suitable for video communication. The port will operate, but we recommend that this be addressed. If Alarm on Link Loss is set to Yes, the Dashboard™ Card State will be yellow if there are no higher-priority alarms present.

- ● **No Link:** The port does not currently have link. If Alarm on Link Loss is set to Yes, the DashBoard™ Card State will be red and the front panel **STAT** LED will also be red. If Alarm on Link Loss is set to No, this indicator will still be red, but the alarm will not propagate.
- **Port 1/2 Status:** This indicator is the port overrun status. It has the following states:
  - ● **OK:** The port is operating normally.
  - ● **TX Overflow:** In the current configuration, the IP outputs are attempting to transmit more than the port capacity (i.e., the overall output data for this port exceeds the interface speed of 100 Mb/s or 1 Gb/s). The DashBoard™ Card State will be red and the **STAT** LED will also be red. In this case, reduce the output bit rate (either by reducing the encoder bit rates or by removing output ports). **If this indicator is red, data is being dropped.**
- **Link Speed (Mb/s):** This parameter reports the actual speed negotiated with the switch for the port. If the port has no link, the value reported here is zero.
- **MAC Address:** This reports the MAC address of the Ethernet port.

### Network Statistics DNS Tab

The Network Statistics DNS Tab reports the current DNS configuration.

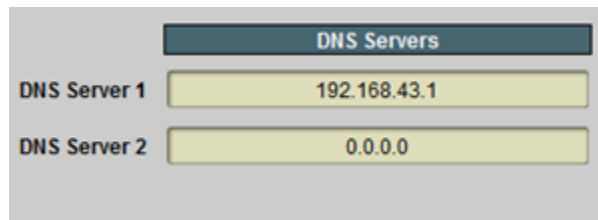

DNS Servers	
DNS Server 1	192.168.43.1
DNS Server 2	0.0.0.0

### Network Statistics RIST Tunnels Tab

This tab shows the current configuration of the RIST tunnels. Only the enabled parameters are displayed.

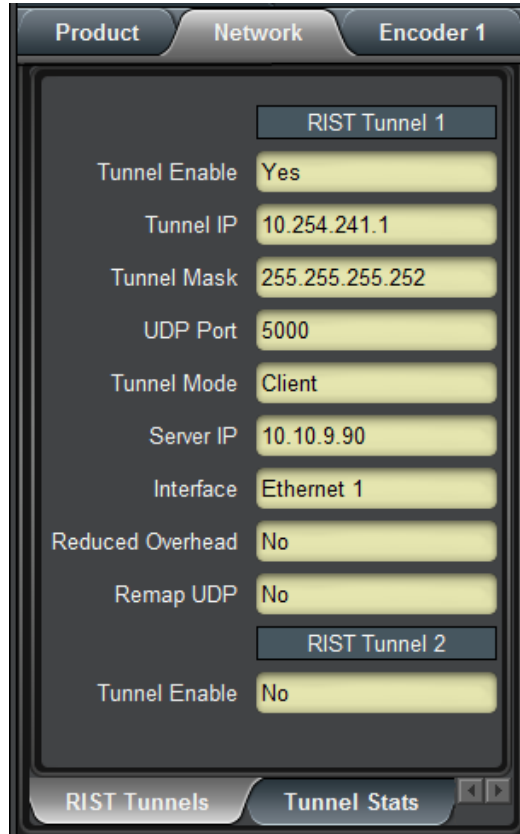

### Network Statistics Tunnel Stats Tab

This tab is only present if there is at least one tunnel enabled, and only has entries for the enabled tunnels. The content is displayed below.

RIST Tunnel 1 Statistics			
	TX	RX	Dropped
Full Datagram	0	0	0
Reduced Overhead	0	0	0
Keep-Alive	213	209	0
TX Rate (b/s)	1,390		
RX Rate (b/s)	1,414		
Remote Endpoint	10.10.9.90:5000		
Remote MAC	ac:83:f0:00:90:bc		

The fields are:

- Full Datagram, Reduced Overhead, and Keep-Alive:** These fields show the number of received, transmitted, and dropped packets of each kind since the tunnel was established. A non-zero dropped count means that invalid packets are being received in the tunnel.

- **TX Rate (b/s):** This field shows the rate at which the 9223-ENC is transmitting in the tunnel, in bits/second.
- **RX Rate (b/s):** This field shows the rate at which the 9223-ENC is receiving packets from the tunnel, in bits/second.
- **Remote Endpoint:** This field shows the IP address and UDP port of the remote endpoint to which the 9223-ENC is connected. If the tunnel is configured as a client, this should match the server IP address and UDP port. If the tunnel is configured as a server, this will report the client's IP address and UDP port (which does not necessarily match the port at which the server is listening).
- **Remote MAC:** This field reports the remote MAC Address, if supplied in the Keep-Alive message. This field will be blank if the remote side does not send RIST Keep-Alive messages. While Cobalt devices will always send this information, it is legal for third-party devices to not include it.

### Network Statistics Remote Info Tab

RIST Main Profile defines an optional informational Keep-Alive message. If such message is present, its contents will be displayed in this tab. While all Cobalt devices generate these messages in RIST Main Profile mode, it is legal for peers not to send them. If these messages are not present, all the fields in this tab will be blank.

RIST Tunnel 1 Remote Info	
Features	RBEVJ
Tunnel IP	10.254.241.2
Remote IP	
Routing	
Vendor	Cobalt Digital Inc.
Product	BBG-1190-DEC-MPEG
Version	1.2.21

The fields are:

- **Features:** The Keep-Alive message has a number of feature flags. This field shows which flags are present in the message, as follows:
  - **X:** More capabilities. If this flag is set, it indicates that there are more capabilities included in the message.
  - **R:** Routing capability. If this flag is set, the device is willing to transmit and receive non-RIST traffic.
  - **B:** If this flag is set, device supports Bonding.
  - **A:** If this flag is set, device supports Adaptive Encoding.
  - **P:** If this flag is set, device supports SMPTE-2022 FEC.

- 
- **E:** If this flag is set, device supports seamless redundancy switch as per SMPTE-2022-7.
  - **L:** If this flag is set, device supports load sharing.
  - **N:** If this flag is set, device supports NULL packet deletion.
  - **V:** If this flag is set, device supports Reduced Overhead Mode.
  - **J:** If this flag is set, device is capable of sending, receiving and processing JSON information.
- **Tunnel IP:** This indicates the remote inner (tunnel) IP address, reported by the peer.
  - **Remote IP:** This indicates the IP address the peer would like the 9223-ENC to take. This feature is not supported by the 9223-ENC. This value, if present, will be reported here but ignored.
  - **Routing:** This indicates that the peer is capable of routing. Cobalt devices currently do not generate this flag.
  - **Vendor:** This indicates the vendor of the peer. Cobalt devices will report “Cobalt Digital Inc”.
  - **Product:** This indicates the product name of the peer. The 9223-ENC will report its actual model number.
  - **Version:** This indicates the software version currently running in the peer. The 9223-ENC will report the value found in the **Software Rev** field found in the Product Tab.

---

## Encoder 1, Encoder 2 Tabs

The Encoder 1/Encoder 2 Tabs are used to configure/monitor the individual encoder channels. The parameters in these two tabs are identical. The 9223-ENC can be configured with one or two encoder channels (at the time the unit is ordered, factory installed). It is possible to upgrade a single channel 9223-ENC unit to dual channel by returning it to Cobalt Digital.

If an encoder channel is not installed, both its configuration and statistics windows will be empty, as shown below.

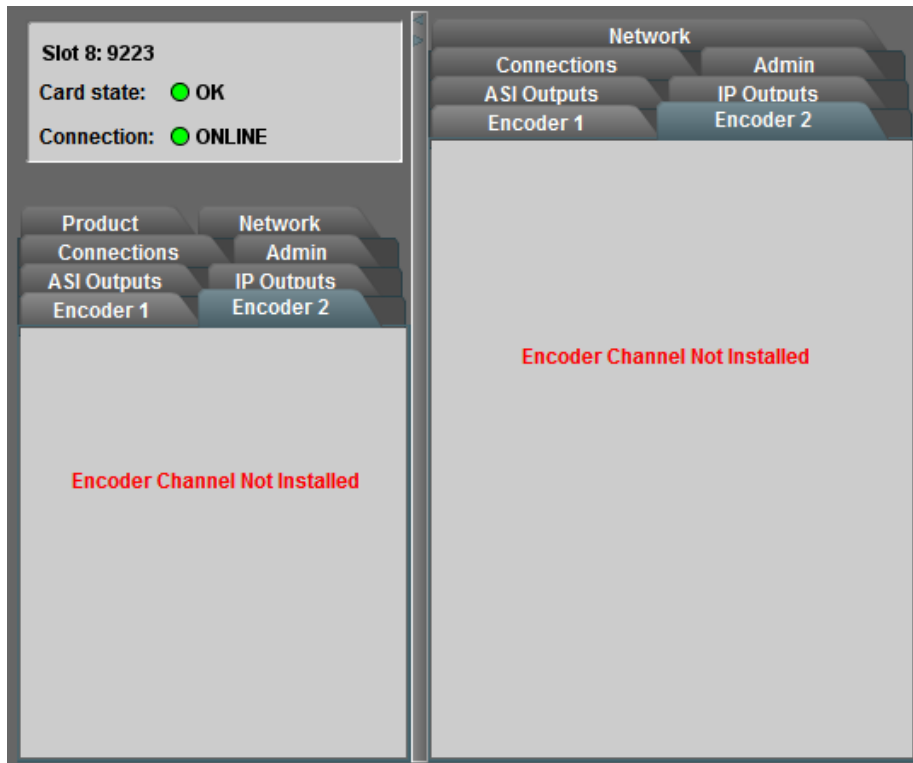

### ***Encoder Configuration Tab***

The Encoder Configuration Tab is further divided into the following 3 tabs:

- **Basic Tab:** contains the more important configuration parameters, which all users are likely to change.
- **Advanced Tab:** contains the advanced configuration parameters, which do not necessarily need to be changed.
- **Connections Tab:** allows the creation of connections between this encoder and the ASI and IP output ports.

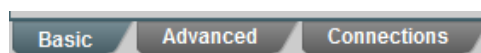

### **Configuration Tabs**

---

In general, the encoder user interface will change as a function of the parameter selections made, to remove illegal parameter combinations.

Selections made in any of the encoder configuration screens do not take effect until the **Apply** button is pressed. If you wish to discard the changes made to the user interface, press the **Cancel** button. The **Apply/Cancel** buttons are present in all the tabs and will be grayed out until changes are made. At any given point in time, the currently running encoder configuration can be inspected in the Encoder Statistics Tab, described later in this document.

## Video Input Auto-Detection

The 9223-ENC can be set to auto-detect the video input signal, and self-configure for the incoming resolution and frame rate. This feature allows the encoder to operate in situations where the video signal can change over time (for example, at the output of a video switch). The 9223-ENC is even capable of automatically recognizing whether a signal is SDI or composite, and the video standard for composite signals.

The following points should be considered when using video input auto-detection:

- The available output scaling options are limited, since some options are specific to some input resolutions.
- If the encoder is not licensed for a given configuration, it will stop encoding if the input video signal switches to a value that requires this configuration. For example, an SD encoder configured to output the same resolution as the input will stop if the input signal switches to HD.
- If the encoder is configured with auto-detection and SDI embedded audio, it will fall back to analog audio if it detects a composite video signal. If your input can switch between SDI and composite, either use analog audio for all signals, or make sure that the corresponding analog audio signal is present at the encoder audio inputs when the video is a composite signal.

## Multiple Audio Support

The 9223-ENC can be licensed to offer up to two additional MPEG-1 Layer II audio channels, regardless of the number of installed encoders. These additional audio channels can be associated with the first or second encoder. Moreover, a dual-channel encoder can be configured as a single-channel encoder with combined audio. The following combinations are supported:

- Single Channel Encoders: support for 1, 2 or 3 audio stereo pairs, as follows:
  - First stereo pair:
    - MPEG-1 Layer II, AAC-LC or Dolby Passthrough support
    - Valid inputs: analog audio, SDI embedded (SDI signals only)
  - Second stereo pair:
    - MPEG-1 Layer II support only
    - Valid inputs: second analog audio, SDI embedded (SDI signals only)
  - Third stereo pair (only available for SDI inputs):
    - MPEG-1 Layer II support only
    - Valid input: SDI embedded



- 
- Dual Channel encoders: support for 1 or 2 audio stereo pairs per encoder channel, as follows:
    - First stereo pair:
      - MPEG-1 Layer II, AAC-LC or Dolby Passthrough support
      - Valid inputs: analog unbalanced audio, SDI embedded (SDI signals only)
    - Second stereo pair (only available for SDI inputs):
      - MPEG-1 Layer II support only
      - Valid input: SDI embedded
  - Dual Channel encoders can be configured to have one encoder channel with 3 audio stereo pairs, and another encoder channel with 1 audio stereo pair, as follows:
    - Encoder with 1 stereo pair:
      - MPEG-1 Layer II, AAC-LC or Dolby Passthrough support
      - Valid inputs: analog audio, SDI embedded (SDI signals only)
    - Encoder with 3 stereo pairs:
      - First stereo pair:
        - MPEG-1 Layer II, AAC-LC or Dolby Passthrough support
        - Valid inputs: analog audio, SDI embedded (SDI signals only)
      - Second stereo pair (only available for SDI inputs):
        - MPEG-1 Layer II support only
        - Valid input: SDI embedded
      - Third stereo pair (only available for SDI inputs):
        - MPEG-1 Layer II support only
        - Valid input: SDI embedded
  - Dual Channel encoders with combined audio: support for up to 4 audio stereo pairs per board, as follows:
    - First stereo pair:
      - MPEG-1 Layer II, AAC-LC or Dolby Passthrough support
      - Valid inputs: analog audio, SDI embedded (SDI signals only)
    - Second stereo pair:
      - MPEG-1 Layer II, AAC-LC or Dolby Passthrough support
      - Valid inputs: second analog audio, SDI embedded (SDI signals only)
    - Third stereo pair (only available for SDI inputs):
      - MPEG-1 Layer II support only
      - Valid input: SDI embedded
    - Fourth stereo pair (only available for SDI inputs):
      - MPEG-1 Layer II support only

- Valid input: SDI embedded

Additional audio encoding capable of supporting additional MPEG-1 Layer II stereo or mono encoding instances without any additional hardware. (License **+2A** is required for this feature.) Each +2A license allows adding a mono/stereo audio PID. See the table below for more information and examples.

Single-Channel Encoders 9223-S (9223-SA-S)		
Base	One +2A License	Two +2A Licenses
1 Stereo PID	2 Stereo PIDs	3 Stereo PIDs
Dual-Channel Encoders 9223-D (9223-SA-D)		
Base	One +2A License	Two +2A Licenses
2 Stereo PIDs	3 Stereo PIDs (Added PIDs per licensing can be applied to Encoder 1 or Encoder 2 channels)	4 Stereo PIDs (Added PIDs per licensing can be applied to Encoder 1 or Encoder 2 channels as desired, also including configuring the device as single-channel with 4 total Stereo PIDs in one encoder channel)
<b>Note:</b> • Maximum of two (2) +2A licenses can be added to single-channel (-S) or dual-channel encoder (-D). • For Dual-Channel Encoders, added +2A audio channels can only be sourced from de-embedded SDI.		

## Encoder Basic Configuration Tab

The Encoder Basic Configuration Tab, shown below, is divided into three general areas:

- **General Configuration:** generic configuration parameters.
- **Video Configuration:** parameters related to video encoding.
- **Audio Configuration:** parameters related to audio encoding.

Encoder 1 Configuration

Name

Encoder State  Stopped  Running

Input Connection  Video/Audio 1  Video/Audio 2

Video Parameters

Video Input Settings  Manual Selection  Auto Detected

Input Resolution

Input Source

Frame/Field Rate  59.94 (NTSC)  50 (PAL)  60

Output Resolution

Video Rate Mode  CBR  VBR

Bit Rate Selection  Video Bit Rate  Transport Bit Rate

Video Bit Rate

Audio Parameters

Sample Rate

Secondary Audio  Disabled  Enabled

Enable First Additional Audio

Audio Source  Analog Audio  SDI Embedded Audio

Language Code

Audio Encoding

Mode

Audio Bit Rate (kb/s)

**General Configuration**

**Video Configuration**

**Audio Configuration**

**Apply/Cancel Configuration Changes**

Note that the basic configuration tab may look different from what is depicted below, as the parameters may change (or appear/disappear in the GUI) based on the device's configuration and the parameter choices made.

### Basic Tab – General Configuration

- **Name:** All 9223-ENC encoders and outputs can be assigned a user-defined name. This name is used to identify the encoder later when making connections. Use any descriptive name suitable for your application, or accept the default.
- **Encoder State:** This control allows you to start/stop an encoder. This control needs to be set to **Running** for normal operation.
- **Input Connection:** This control selects which of the two rear panel inputs is to be connected to this encoder. The 9223-ENC can run both encoders from the same input. The default is to run Encoder 1 from Video/Audio 1 and Encoder 2 from Video/Audio 2, but all combinations are allowed. Note that the parameters presented in the Video Configuration section may change if this selection changes (for example, if you switch the encoder from a Composite input to an SDI input).

The screenshot displays the 'Encoder 1 Configuration' window, which is organized into three main sections: General Configuration, Video Configuration, and Audio Configuration. Each section is highlighted with a red rounded rectangle. The General Configuration section includes fields for Name (Encoder 1), Encoder State (Running), and Input Connection (Video/Audio 1). The Video Configuration section includes Input Resolution (SD: 720x480i), Input Source (Composite), Frame/Field Rate (59.94 NTSC), Output Resolution (Output 720x480i), Video Rate Mode (CBR), and Video Bit Rate (2000000). The Audio Configuration section includes Sample Rate (48 kHz), Secondary Audio (Disabled), Audio Source (Analog Audio), Language Code (eng), Audio Encoding (MPEG-1 Layer II), Mode (Stereo), and Audio Bit Rate (192). At the bottom, there are 'Apply' and 'Cancel' buttons, with a red box around them and the text 'Apply/Cancel Configuration Changes'.

**Encoder 1 Configuration**

Name: Encoder 1

Encoder State:  Stopped  Running

Input Connection:  Video/Audio 1  Video/Audio 2

**Video Parameters**

Input Resolution: SD: 720x480i

Input Source: Composite

Frame/Field Rate:  59.94 (NTSC)  50 (PAL)

Output Resolution: Output 720x480i

Video Rate Mode:  CBR  VBR

Video Bit Rate: 2000000

**Audio Parameters**

Sample Rate: 48 kHz

Secondary Audio:  Disabled  Enabled

Audio Source:  Analog Audio  SDI Embedded Audio

Language Code: eng

Audio Encoding: MPEG-1 Layer II

Mode: Stereo

Audio Bit Rate (kb/s): 192

Apply Cancel

**General Configuration**

**Video Configuration**

**Audio Configuration**

**Apply/Cancel Configuration Changes**

---

## Basic Tab – Video Configuration

The 9223-ENC is capable of automatically identifying the video signal present in the selected input connection. The detected signal is reported in the Encoder Statistics Tab. Additionally, the encoder can also be set to auto-configure its input based on the detected signal:

- **Video Input Settings:** This parameter selects whether or not the encoder will auto-configure based on the detected video input signal.
  - **Manual Selection:** The input signal must be correctly selected using the **Input Resolution**, **Input Source**, and **Field/Frame Rate** controls for the encoder to run. If the input signal does not match the settings, the encoder will not run.
  - **Auto Detected:** The encoder will auto-detect the input signal, and automatically configure for it if it is a supported signal. The **Input Resolution**, **Input Source**, and **Field/Frame Rate** controls are not displayed.

Video Input Settings  Manual Selection  Auto Detected

Input Resolution SD: 720x480i ▼

Input Source Composite ▼

Frame/Field Rate  59.94 (NTSC)  50 (PAL)

Output Resolution Output 720x480i ▼

Video Rate Mode  CBR  VBR

Video Input Settings  Manual Selection  Auto Detected

Output Resolution Same as Input ▼

Video Rate Mode  CBR  VBR

The following table lists the supported input video signals:

Composite Signals	SDI Signals
NTSC	720×480i59.94
NTSC 4.43	720×576i50
PAL B/D/G/H/I/N	<i>1280×720p23.98</i>
PAL-M	<i>1280×720p24</i>
PAL-Nc	<i>1280×720p25</i>
SECAM	<i>1280×720p29.97</i>
	<i>1280×720p30</i>
	1280×720p50
	1280×720p59.94
	1280×720p60
	1920×1080p23.98
	<i>1920×1080p24</i>
	<i>1920×1080p25</i>
	<i>1920×1080p29.97</i>
	<i>1920×1080p30</i>
	1920×1080i50
	1920×1080i59.94
	1920×1080i60
	1920×1080p50
	1920×1080p59.94
	<i>1920×1080p60</i>

In the above table, the signals indicated in *italic blue* are only supported in input auto-detect mode.

If **Video Input Settings** is set to **Manual Selection**, the **Input Resolution**, **Input Source** and **Field/Frame Rate** parameters are displayed and must be set to match the incoming video signal.

- **Input Resolution:** Select the resolution of the input video signal. The following four choices are available:
  - SD: 720×480i (this will be presented as 720×576i if **Field/Frame Rate** is set to **PAL**).
  - HD: 1280×720p
  - HD: 1920×1080i
  - HD: 1920×1080p
- **Input Source:** Select the input source type. This control is available only if the **Input Resolution** is set to SD. In this case, the options will be **Composite** or **SD-SDI**. If **Input Resolution** is set to any of the HD values, this control will not be selectable, and will show the appropriate type of input (HD-SDI for 1280×720p and 1920×1080i, and 3G-SDI for 1920×1080p).
- **Field/Frame Rate:** Select to match your source. For all input resolutions, the supported options always include 59.94 (for NTSC-based systems) and 50 (for PAL-based systems). Some resolutions have support for additional frame rates, as follows:

- If you select the 1920×1080i or 1280×720p resolutions, this field will also include an option for a field rate of 60, used by some cameras:

Input Resolution: HD: 1920x1080i

Input Source: HD-SDI

Frame/Field Rate:  59.94 (NTSC)  50 (PAL)  60

- If you select the 1920×1080p resolution, this field will also include an option for a frame rate of 23.98 (Film):

Input Resolution: HD: 1920x1080p

Input Source: HD-SDI

Frame/Field Rate:  59.94 (NTSC)  50 (PAL)  23.98 (Film)

- **Output Resolution:** Select the desired output resolution. The values in this drop-down list are a function of the **Input Resolution** and the **Frame/Field Rate**. Also, please note that some resolutions require additional licensing for the encoder. The following resolutions are offered:
  - Same as the input (no scaling)
  - ¾ scaling from the input
  - Low resolutions: 480×270, 320×240, and 320×180, progressive, at half and quarter frame rates (not available for 1080p inputs)
  - HD inputs can be scaled (and re-interlaced if necessary) to SD resolution, anamorphic (not available for 1080p inputs)
  - 720p inputs can be reduced to half frame rate (typically for Internet applications), as follows:
    - 1280×720p50 is converted to 1280×720p25
    - 1280×720p59.94 is converted to 1280×720p29.97
    - 1280×720p60 is converted to 1280×720p30
  - 1080i, 720p and SD inputs can be converted to SD resolution, with progressive frame rates (ideal for computer displays), as follows:
    - 1080i59.94, 720p59.94, and 480i59.94 are converted to 720×480p29.97
    - 1080i60 and 720p60 are converted to 720×480p30
    - 1080i50 and 720p50 are converted to 720×576p25
 The conversions from HD resolutions are done using anamorphic scaling.
  - 1080i, 720p and SD<sup>2</sup> inputs can be scaled to 640×360, with progressive frame rates, as follows:
    - 1080i59.94 and 480i59.94 are converted to 640×360p29.97
    - 720p59.94 is converted to 640×360p59.94

<sup>2</sup> By default, SD signals have a 4:3 aspect ratio, unless they are derived from an HD source with anamorphic scaling. The 640×360 resolution is intended for 16:9 content. Scaling SD to 640×360 should only be done if the SD signal is anamorphic to start with, otherwise the resulting encoded signal will have an incorrect aspect ratio.

- 1080i50 and 576i50 are converted to 640×360p25
  - 720p50 is converted to 640×360p50
- HD 1080i inputs can be converted to progressive signals at the same frame rate. Namely, 1080i59.94 can be converted to 1080p29.97, 1080i50 can be converted to 1080p25, and so on.
- HD 1080i inputs can be scaled to 1280×720p at the same incoming frame rate (e.g., 1080i59.94 will be scaled to 720p29.94; 1080i50 will be scaled to 720p25)
- HD 1080i inputs can be scaled to ¼ resolution (960×540), with the same incoming frame rate
- SD inputs can be horizontally cropped to 704 pixels or horizontally scaled to 640 pixels
- SD inputs can be horizontally scaled to 640 or 528 pixels, and converted to progressive frame rates (29.97p for NTSC inputs, 25p for PAL inputs)

If **Video Input Settings** is set to **Auto Detected**, the following options are offered in this parameter:

- **Same as Input:** the encoder will produce a signal that has the same resolution and frame rate as the input (no scaling).
  - **Scale 3/4 Horizontal:** the encoder will scale down the image horizontally by 3/4. The frame rate will not be changed.
  - **Scale to 640×360p:** the encoder will scale the input video to 640×360. The frame rate will be the same as the input, but interlaced inputs will be de-interlaced (for example, 1920×1080i60 will yield 640×360p30). This resolution is not available for 1920×1080p inputs at any frame rates; the encoder will fall back to 3/4 horizontal scaling in this case.
  - **Scale to 480×270p, Scale to 320×240p, Scale to 320×180p:** the encoder will scale the input video to the selected resolutions. Interlaced inputs will be de-interlaced as described above. Progressive inputs will be encoded at half frame rate. This resolution is not available for 1920×1080p inputs at any frame rates; the encoder will fall back to 3/4 horizontal scaling in this case.
- **Video Rate Mode:** This controls whether the video elementary stream is CBR or VBR. The video bit rate setting varies according to this selection, as shown below.

Video Rate Mode  CBR  VBR

Bit Rate Selection  Video Bit Rate  Transport Bit Rate

Video Bit Rate

Video Rate Mode  CBR  VBR

Peak Video Rate

Average Video Rate

- **Bit Rate Selection:** This field is shown only if the encoder is set to **CBR** mode, and allows the user to specify either the video bit rate, or the transport bit rate. The transport bit rate includes audio, video, tables, NULL packets, and various overheads. In some situations, such as for example, RF links of fixed capacity, it is more convenient to specify the transport rate (i.e., the final bit rate “in the wire”), and let the encoder compute the corresponding video bit rate to yield the desired transport rate. In other situations, such as IPTV deployments, it is more convenient to simply specify the video



---

bit rate and let the encoder compute the final transport rate. Note that this control is not available in the OTT protocol modes. The controls displayed vary according to this selection:

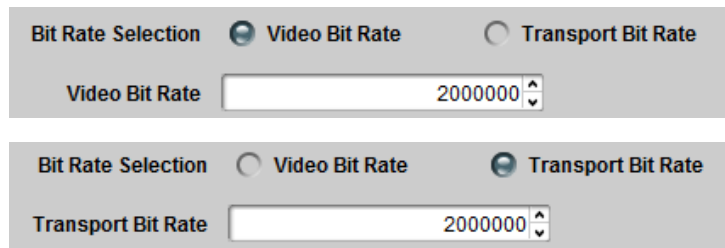

- **Video Bit Rate:** This field is shown only if the encoder is set to **CBR** mode and the Bit Rate Selection control is set to **Video Bit Rate**. It determines the video elementary stream bit rate, expressed in bits/second. Note that the bit rate resolution is 1000 bits/second.
- **Transport Bit Rate:** This field is shown only if the encoder is set to **CBR** mode and the Bit Rate Selection control is set to **Transport Bit Rate**. It determines the overall transport stream bit rate, with a resolution of 1000 bits/sec; the encoder will calculate the appropriate video bit rate the yield the desired transport rate. Please note that all transport rates are achievable; in particular, the encoder may not be able to achieve very low transport rates if the audio bit rates are high. In these cases, the actual transport rate output by the encoder will be higher than the configured value. The actual transport rate is displayed in the Encoder Statistics Tab, after the **Apply** button has been pressed. At that point, the actual encoder video bit rate can be found in the Encoder Statistics Tab, under the Basic bottom tab.
- **Peak Video Bit Rate, Average Video Bit Rate:** These two fields are shown only if the encoder is set to **VBR** mode, and determine the desired average and acceptable peak bit rates for the video elementary stream. The peak video bit rate must be between 2.1 and 2 times the average bit rate; the user interface will enforce these limits automatically (i.e., it will update either the average or peak to be consistent with the value being entered). For both of these parameters, the resolution is 1000 bits/sec.

## Basic Tab – Audio Configuration

- **Audio Source:** This parameter selects the audio source. The options are **Analog Audio**, directing the encoder will to use the analog right/left audio channels connected to the selected rear I/O panel, and **SDI Embedded Audio**, directing the encoder to extract embedded audio from the SDI input. If the video **Input Source** (see Basic Tab – Video Configuration) is set to **Composite**, this parameter is grayed out and forced to **Analog Audio**. It will be selectable only if the video input source is one of the SDI variations, or if **Video Input Settings** is set to **Auto Detected**. Please note that if the encoder is set to auto-detect the video input, and it detects a composite signal, the audio selection will fall back to analog audio regardless of the **Audio Source** settings. When **SDI Embedded Audio** is selected, additional configuration options become available, as shown below.

- Group, Channels:** SDI embedded audio is typically divided into four groups (denoted by Group 1 to Group 4); each group has four mono channels (2 stereo pairs), denoted by Channels 1-2 and 3-4. These controls allow the selection of the desired group and channel pair. In the large majority of the cases, the first stereo pair is in Group 1, Channels 1-2, the second stereo pair is in Group 1, Channels 3-4, and so on. The **Group** selection has one additional choice, labeled **Custom DID**. This allows the encoder to use a non-standard embedded audio DID (this quite uncommon). If **Custom DID** is selected, a new configuration option becomes available, where the DID can be entered:

- Group DID:** Enter the desired Group DID, in hexadecimal. Only the last 8 bits of the DID/SDID need to be entered – the top two bits are automatically computed and added. As a reference, the table below contains the standard DIDs built into the system for Groups 1 to 4.

Group	SD-SDI DID	HD-SDI DID
Group 1	0x2FF	0x2E7
Group 2	0x1FD	0x1E6
Group 3	0x1FB	0x1E5
Group 4	0x2F9	0x2E4

- Language Code:** This parameter represents the 3-letter ISO 639-2 language code for the audio, to be placed in the audio language descriptor in the PMT. For a complete list of the language codes, see this URL:

[http://www.loc.gov/standards/iso639-2/php/code\\_list.php](http://www.loc.gov/standards/iso639-2/php/code_list.php)

If the Output Protocol in the Encoder Connections Tab is set to RTMP, this field will not be displayed as RTMP does not use the transport stream container.

- Audio Encoding:** This parameter selects the audio encoding algorithm. The available choices depend on the **Audio Source** selection. For **Analog Audio**, the choices are **MPEG-1 Layer II** and **AAC-LC**. For **SDI Embedded Audio**, the **Dolby Passthrough**

option is offered in addition to the previous choices. Note that AAC-LC requires additional licensing. The two variants for this control are depicted below.

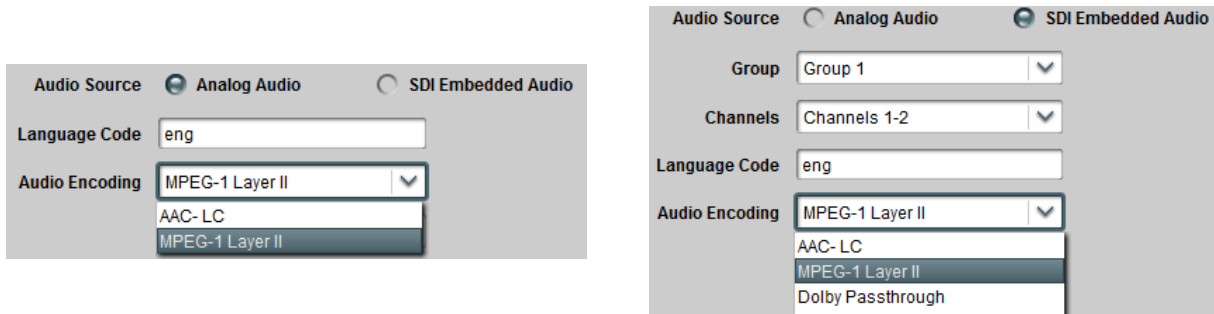

If the Output Protocol in the Encoder Connections Tab is set to RTMP, this field is forced to AAC-LC and becomes not editable. The reason is that the RTMP protocol has no support for MPEG-1 Layer II audio at 48 kHz sampling. It also has no support for Dolby.

- **Mode:** The available choices for this parameter depend on the **Audio Encoding** selection, as follows:
  - **MPEG-1 Layer II:** the available modes are **Stereo** or **Single Channel**. If you select **Single Channel** (Mono), only the audio connected to the Left input will be encoded.
  - **AAC-LC:** the available modes are **Stereo**, **Mono**, or **Dual Mono**. If you select **Mono**, only the audio connected to the Left input will be encoded.
  - **Dolby Passthrough:** This parameter is not displayed.
- **Audio Bit Rate:** The format of this parameter is a function of the **Audio Encoding** setting. For MPEG-1 Layer II, this parameter is a drop-down list of valid discrete bit rates; the values in the list are also a function of the **Mode** Setting. For AAC-LC, the range is 112 to 512 kb/s for Stereo and Dual Mono, and 56 to 256 kb/s for Mono. This parameter is not displayed for Dolby Passthrough as the 9223-ENC will automatically detect the incoming audio bit rate.
- **Peak Audio Bit Rate:** This parameter is only displayed for AAC-LC. It must be set at least 1 kb/s higher than the **Audio Bit Rate**. The maximum value is 288 kb/s for Mono, and 576 kb/s for Stereo and Dual Mono.

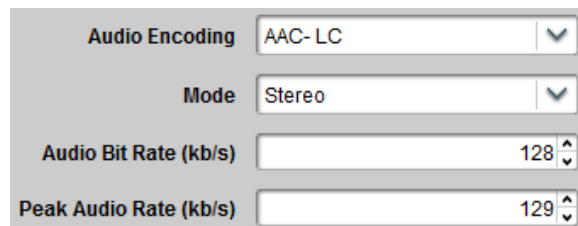

- **Sample Rate:** This field is for information purposes only. The 9223-ENC only supports 48 kHz audio sample rate.

---

## Basic Tab – Additional Audio Support

If the encoder is in a configuration where additional audio channels can be offered, a checkbox to enable them will be presented in the GUI, as indicated below:

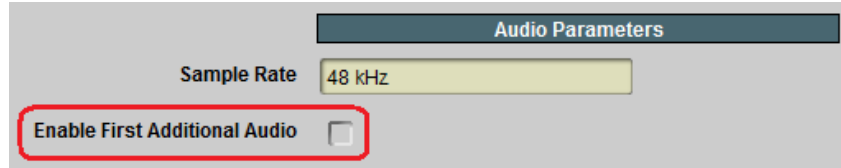

If the box is checked, additional fields will become available for configuring the additional audio channel. These fields are the same as with the first audio channel. Note that, depending on the configuration, the **Audio Source** selection may be grayed out.

After the first additional audio is enabled, the encoder may offer a second additional audio channel, as depicted below:

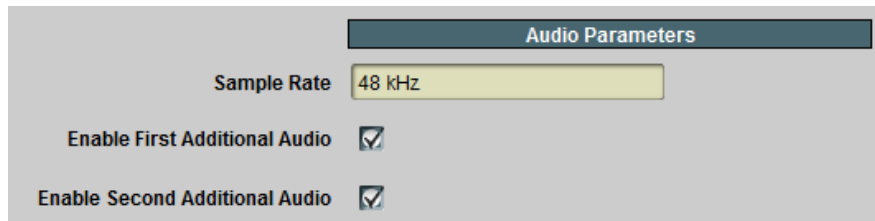

The second additional audio option will be offered in the following conditions:

- In a single-channel encoder, if the input signal type is SDI.
- In a dual-channel encoder, if the first additional audio is not being used by the other encoder channel.
- In a dual-channel encoder, if secondary audio is enabled (see the next section).

Additional audio channels are only available if the Output Protocol in the Encoder Connections Tab is set to ASI/IP Streaming.

---

**Audio Channel 1**

Audio Source  Analog Audio 1  SDI Embedded Audio

Group  ▼

Channels  ▼

Language Code

Audio Encoding  ▼

Mode  ▼

Audio Bit Rate (kb/s)  ▼

**Audio Channel 2 (MPEG-1 Layer II)**

Audio Source  SDI Embedded Audio

Group  ▼

Channels  ▼

Language Code

Mode  ▼

Audio Bit Rate (kb/s)  ▼

---

## Basic Tab – Secondary Audio Support

A dual-channel BBG-1123-ENC can be configured to offer secondary audio support (i.e., a second audio PID in the same program). If this function is available, it will be available in the audio section of Encoder 1, as indicated below:

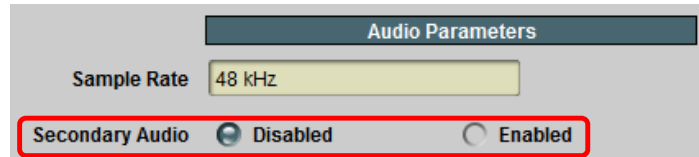

When **Secondary Audio** is set to **Enabled**, the Encoder 1 Audio Configuration section will change as indicated below:

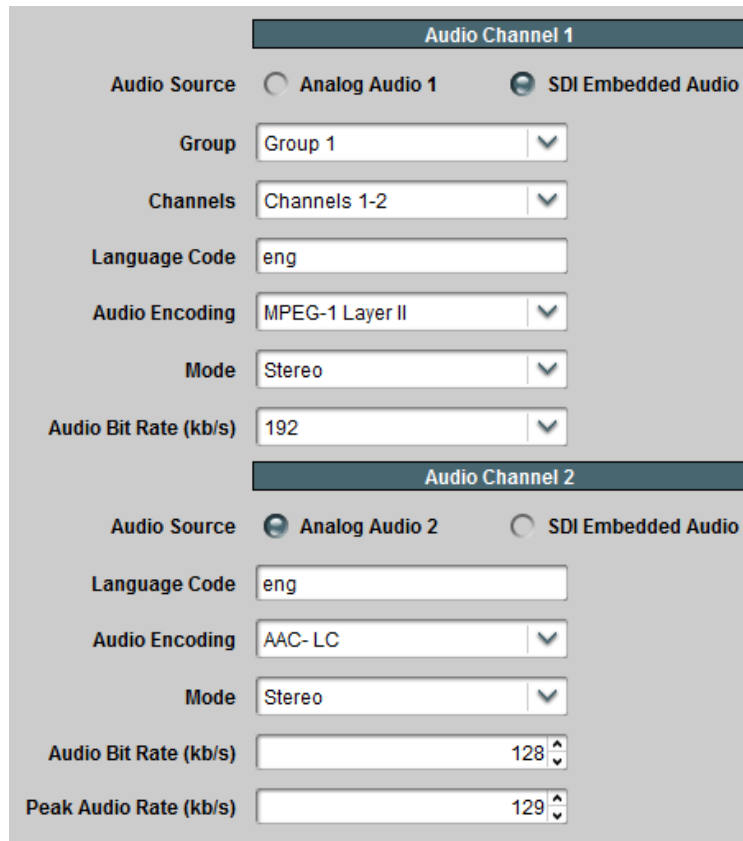

The individual controls work in the same manner as discussed before. Each audio channel can be independently configured. As before, the SDI Embedded Audio option will only be available if the Encoder 1 input selection is one of the SDI variants. The only input restriction is that, when using Analog Audio, the signal connected to Video/Audio 1 will be the first audio channel, and the signal connected to Video/Audio 2 will be the second audio channel.

Secondary audio support can be combined with the two additional audio channels to create one program with up to 4 audio services (i.e., up to 4 audio PIDs).

Support for secondary audio requires that both encoder channels in the board be tied together. When the **Secondary Audio** control depicted above is set to **Enabled**, Encoder 2 will be slaved to Encoder 1. Its Basic Configuration Tab in this mode is depicted below:

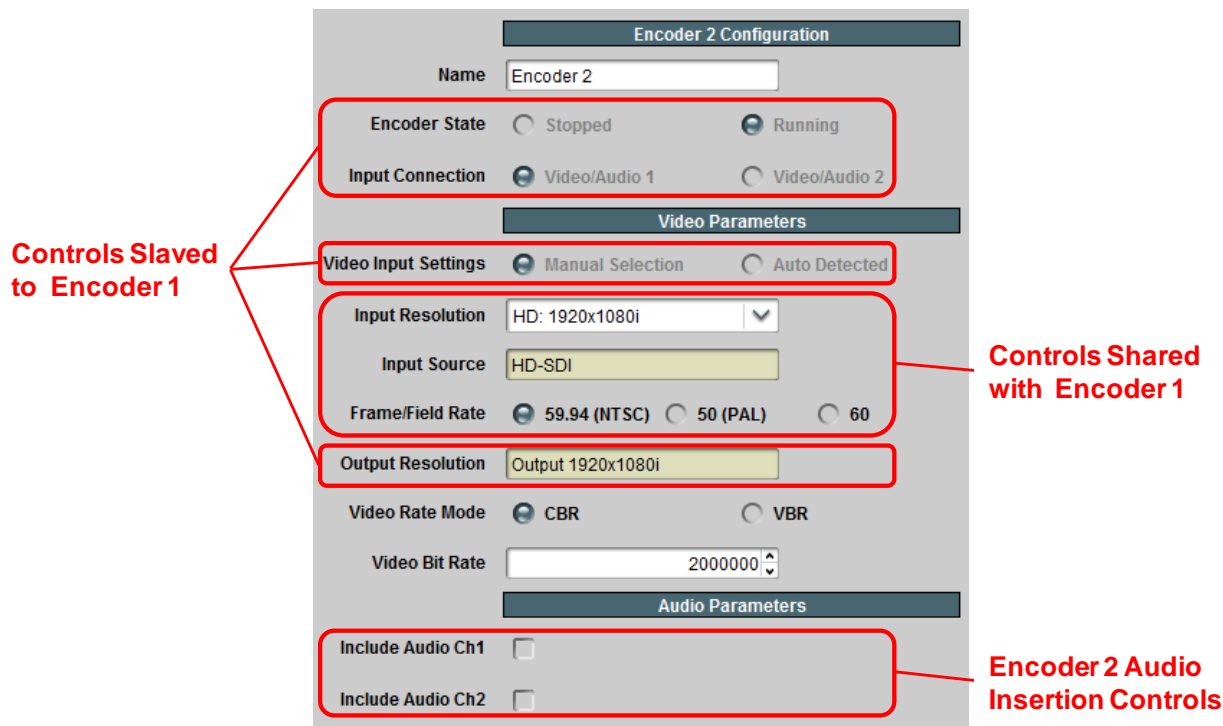

The operation is as follows:

- The **Encoder State**, **Input Selection**, **Video Input Settings**, **Output Resolution** and **Coding Delay** (in the **Advanced Tab**) controls are slaved to the corresponding controls in Encoder 1. They will reflect the state of their Encoder 1 counterparts.
- If **Video Input Settings** in Encoder 1 is set to **Manual Selection**, the **Input Resolution**, **Input Source** and **Field/Frame Rate** controls are shared with Encoder 1, and apply to whatever input port is selected. Changes here will be mirrored in the corresponding parameters for Encoder 1. If **Video Input Settings** in Encoder 1 is set to **Auto Detected**, these controls are not displayed.
- Encoder 2 can optionally share one or both audio channels from Encoder 1. This is accomplished by checking **Include Audio Ch1/2** boxes in the Audio Insertion Controls displayed above.

## Encoder Advanced Configuration Tab

The appearance of the Encoder Advanced Configuration Tab is a function of the choices made in the Multiple Audio Support section of the Encoder Basic Configuration Tab. The Advanced Configuration Tab is divided into four major areas:

- **Video Parameters:** these are advanced controls related to the encoding of the video.
- **VBI/Ancillary Data Insertion:** controls related to Closed-Captioning and Active Format Description (AFD) insertion.
- **Audio Parameters:** these are advanced controls related to the audio subsystem.
- **Mux Parameters:** these are advanced controls related to audio/video multiplexing and (P)SI tables.

## Advanced Tab – Video Parameters

The Video Parameters section is shown below:

The screenshot shows the 'Video Parameters' control panel with the following settings:

- GOP Mode:** Open GOP (selected), Closed GOP
- Level:** Auto-Select
- Profile:** Auto-Select
- GOP Structure:** IBBP (selected), IBP, IP
- Coding Delay (ms):** 500
- Multi-Angle:**

- **GOP Mode:** Select between **Open GOP** and **Closed GOP**. The normal setting is Open GOP. Closed GOP is used for some storage applications, and is also required by some CDNs (such as YouTube); there is a very small negative impact in video quality if Closed GOP is selected. For some output protocols (HLS and RTMP), this control becomes read-only and is forced to Closed GOP.
- **Level:** Selects the H.264 level signaled in the bitstream. The default setting is **Auto-Select**, whereby the encoder will signal the minimum required level based on the current settings. If, for some reason, a different (higher) level is desired, it can be selected here. Note that the encoder will not honor a level selection that is lower than the legal minimum for the current settings. It is typically not necessary to change the level from Auto-Select.
- **Profile:** This control has four options:
  - **Auto-Select:** With this setting, the encoder will use High Profile for HD and Main Profile for SD.
  - **High Profile:** With this setting, the encoder will always use High Profile for all resolutions.
  - **Main Profile:** With this setting, the encoder will always use Main Profile for all resolutions.
  - **Baseline Profile:** With this setting, the encoder will always use Baseline Profile. The **GOP Structure** control will not be selectable in Baseline Profile and will be



---

set to IP. Please note that Baseline Profile does not support interlaced video. If the output is interlaced, the encoder will approximate Baseline Profile by producing Main Profile with CAVLC coding.

Note that, as the profile is lowered, there will be video quality degradation. In other words, for a given resolution and bit rate, the video quality for High Profile will be better than Main Profile, and Main Profile will be better than Baseline Profile. Whether the quality difference is noticeable will depend on the resolution, bit rate, and specific video content.

- **Aspect Ratio:** The H.264 bitstream includes aspect ratio information in the VUI Parameters part of the Sequence Parameter Set. Normally, the encoder will automatically set the correct aspect ratio code. However, in some situations, it may be necessary to override this (for example, when scaling HD to SD). Use this control to override the default aspect ratio set by the encoder. In particular, if the video input is 1920x1080i, and the content is being scaled to SD, use either **16:11 (PAL Widescreen)** or **40:33 (NTSC Widescreen)** to get the correct aspect ratio.
- **GOP Structure:** Select between **IBBP**, **IBP** and **IP**. Selecting **IBBP** gives the best video quality, but some low-end decoders require **IP**. If **Profile** is set to Baseline Profile, this control will not be selectable and will be forced to **IP**.
- **Coding Delay:** This parameter controls the size of the H.264 Coded Picture Buffer (CPB), expressed in milliseconds. This is one component of the end-to-end encoder/decoder delay. The 9223-ENC latency is 150 milliseconds plus the value of this control. For example, if the Coding Delay is set at its default of 500 milliseconds, the 9223-ENC latency will be 650 milliseconds. Note that the overall encoder/decoder latency is also a function of the latencies in the decoder. **Please note that reducing the coding delay will reduce latency at the expense of video quality!** Use VBR if at all possible when reducing the latency, and set the peak rate as high as you can afford. For example, if the encoder output is 1920x1080i, a bit rate on the order of 10 to 12 Mb/s (either CBR average or VBR peak) is required to produce a stream without artifacts with a Coding Delay of 100 milliseconds. Note that, if the **Multi-Angle** feature is enabled, the Coding Delay of Encoder 2 will follow that of Encoder 1 and will not be editable.

**Multi-Angle:** This control is only available in the **Encoder 1** tab of a **dual-channel** encoder. It is not present in the Encoder 2 tab or in single-channel encoders. It enables the creation of a multi-angle SPTS by having the two encoder channels work in tandem. A multi-angle SPTS has two video PIDs in the same program. In order to create a multi-angle SPTS, connect the desired video feeds to the Video 1 and Video 2 inputs, check this box, and connect both encoders to the desired IP or ASI output (refer to the Connections Tab section of this manual).

**IMPORTANT:** the two video feeds to the encoder must be **frame-synchronized prior to connection to the encoder**. Failure to do this will cause the second video to drift in relation to the first and become un-decodable. Cobalt Digital offers several dual-channel frame synchronizers.

Note that if the **Output Resolution** setting in the Basic Tab – Video Configuration is set to one of the low resolutions (480x270, 320x240, or 320x180), the **Profile** and **GOP Structure** controls will not be selectable; this section will appear as follows:

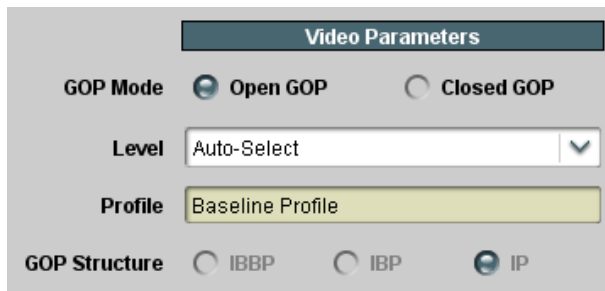

Also note that if the **Input Resolution** setting in the Basic Tab – Video Configuration is set to 1920×1080p, the **Profile** and **GOP Structure** controls will not be selectable; this section will appear as follows:

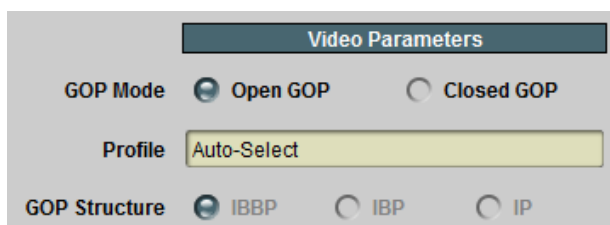

### Advanced Tab – VBI/Ancillary Data Insertion

The 9223-ENC can extract the following data types from the video input and insert them in the compressed video output:

- Closed Captioning
- Active Format Description (AFD)
- SCTE 104 Ad Insertion Triggers
- Any other generic ANC data types, which are inserted using SMPTE-2038.

#### *Closed Captioning*

The Closed Captioning controls are only displayed in the following situations:

- In the Basic Tab – Video Configuration, **Video Input Settings** is set to **Manual Selection**, and **Frame/Field Rate** is set to **59.94 (NTSC)**.
- In the Basic Tab – Video Configuration, **Video Input Settings** is set to **Auto Detected**.

The appearance of this control is also a function of the **Video Input Settings**, **Input Resolution** and **Input Source** parameters, as depicted below.

The Closed Captioning controls are as follows:

- **Enable CC:** check this box to enable Closed-Captioning insertion. Closed Captions are inserted in the video elementary stream, as per ATSC A/72. Both CEA-608 and CEA-708 captions are supported.

- 
- **CC Source:** this controls where the encoder extracts closed captions from. As depicted below, this field may or may not be editable, depending on the video input settings, input resolution and input source. The options are:
    - **CEA-608 Line 21:** this option can only be used for SD inputs. The encoder will extract all the CEA-608 information from both fields of Line 21, if present.
  - **SMPTE-334 VANC:** this option can only be used for SDI inputs. The encoder will expect closed-captioning information in the VANC. Both CEA-608 and CEA-708 modes are supported (and automatically detected).
  - **Allowed CC Types:** this parameter is only displayed if **CC Source** is set to **SMPTE-334 VANC**. The SMPTE-334M specifies two types of Closed-Captioning information in the VANC:
    - EIA-708 captions on DID 0x161, SDID 0x101
    - EIA-608 captions on DID 0x161, SDID 0x102

This control has the following settings:

- **Both SMPTE-334 608 and 708:** the encoder will accept and process either format. However, note that if both formats are present, the captions will be inserted twice.
- **SMPTE-334 708 Only:** the encoder will accept only EIA-708 captions on DID 0x161, SDID 0x101, and will discard any EIA-608 captions received on DID 0x161, SDID 0x102.
- **SMPTE-334 608 Only:** the encoder will accept only EIA-608 captions on DID 0x161, SDID 0x102, and will discard any EIA-708 captions received on DID 0x161, SDID 0x101.

Note that if **Video Input Settings** is set to **Auto Detected**, the encoder will comply with the **CC Source** if possible, but may fall back to another setting depending on the input signal. For example, if **CC Source** is set to **CEA-608 Line 21** and the encoder detects an HD signal, it will fall back to **SMPTE-334 VANC**. Conversely, if it is set to **SMPTE-334 VANC** and it detects a composite signal, it will fall back to **CEA-608 Line 21** if that composite signal is NTSC, or turn off CC if that composite signal is PAL.

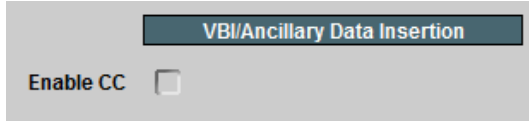

**Closed-Captioning Disabled**

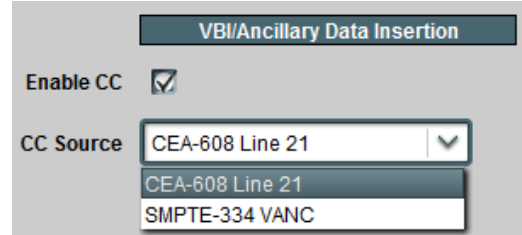

**Input Source: SD-SDI  
Input Resolution: SD**

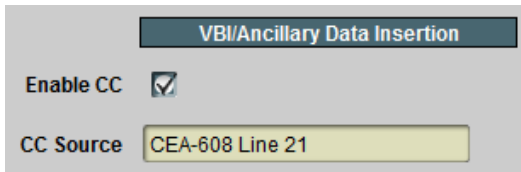

**Input Source: Composite  
Input Resolution: SD**

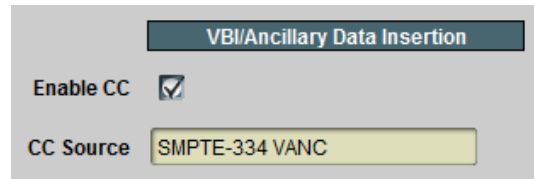

**Input Source: HD-SDI or 3G-SDI  
Input Resolution: HD**

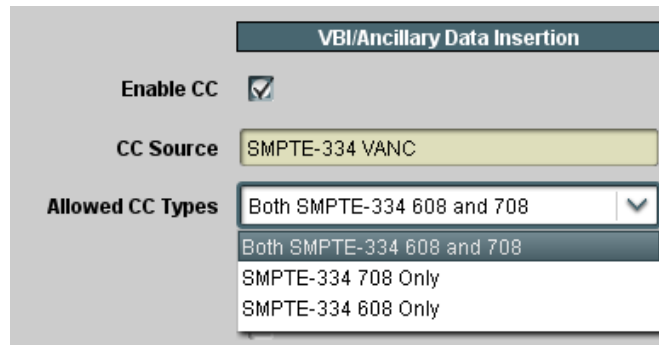

### ***Active Format Description***

The 9223-ENC can extract Active Format Description (AFD) information from the incoming video signal and insert it in the compressed bitstream. AFD information can be extracted from the following sources:

- For SDI signals, AFD information can be present in the VANC as per SMPTE-2016-3. This is the primary way of conveying AFD information on a professional video feed.
- For SD signals (either from Composite or SD-SDI sources), AFD information can be synthesized from Wide Screen Signaling (WSS) data present in the VBI (line 20 for NTSC signals, line 23 for PAL signals).
- The 9223-ENC also has the option of inserting a user-defined AFD code (instead of receiving it from the video input).

The AFD controls are as follows:

- **Enable AFD:** Check this box to enable AFD extraction and insertion. This control is always available. AFD is inserted in the video elementary stream as per ATSC A/72 and ETSI TS 101 154.

- **AFD Source:** This controls where the AFD information is coming from. The options are:
  - **Line 20 WSS/Line 23 WSS:** This option causes the encoder to synthesize AFD information from WSS. It is available only if the input resolution is SD. It will be displayed as Line 20 for NTSC and Line 23 for PAL. For PAL inputs, the conversion follows ETSI TS 101 154 Appendix B.4.
  - **SMPTE-2016-3 VANC:** This option causes the encoder to extract AFD from the VANC. It is only available for SDI inputs.
  - **Manual AFD Selection:** This option allows the user to specify a fixed AFD code to be inserted. Any AFD information received from the input is ignored. This can be used to override the original AFD information, or when the video is being scaled (e.g., when the input is HD and is being converted to SD).
- **AFD Code:** This control is displayed only when AFD Source is set to Manual AFD Selection. It corresponds to the codes listed in SMPTE-2016-1, Table 1.

The diagram illustrates the AFD control interface for different video formats. On the left, a 'VBI/Ancillary Data Insertion' panel has 'Enable AFD' checked. Three red arrows point from this panel to three separate AFD Source dropdown menus. The top menu is labeled 'Composite' and shows 'Line 20 WSS' selected. The middle menu is labeled 'SD-SDI Auto-Detected' and shows 'SMPTE-2016-3 VANC' selected. The bottom menu is labeled 'HD' and shows 'SMPTE-2016-3 VANC' selected. Below these is a detailed view of the 'Manual AFD Selection' dropdown, showing a list of AFD codes and their corresponding frame types, with '1000: Full Frame 16:9' selected.

AFD Code	Frame Type
0000	Undefined
0010	Full Frame 16:9
0011	Pillarbox 14:9 Center
0100	Letterbox more than 16:9 Center
1000	Full Frame 16:9
1001	Pillarbox 4:3 Center
1010	Full Frame 16:9 Protected
1011	Pillarbox 14:9 Center

---

Note that if **Video Input Settings** is set to **Auto Detected**, the encoder will comply with the **AFD Source** if possible, but may fall back to another setting depending on the input signal. For example, if **AFD Source** is set to **Line 20/23 WSS** and the encoder detects an HD signal, it will fall back to **SMPTE-2016-3 VANC**. Conversely, if it is set to **SMPTE-2016-3 VANC** and it detects a composite signal, it will fall back to **Line 20/23 WSS** (and automatically use the correct line number based on the input signal). **Manual AFD Selection** is always honored.

### ***SCTE 104 Ad Insertion Triggers***

If the input signal is SDI, the 9223-ENC is capable of extracting SCTE 104 triggers from the VANC (inserted as per SMPTE 2010) and converting them to SCTE 35 triggers in the output transport stream:

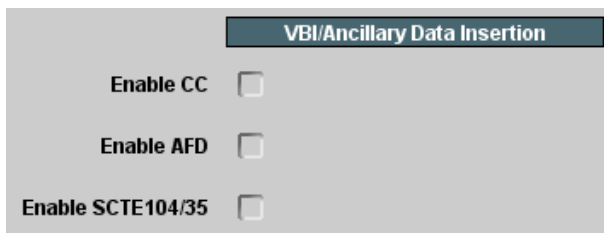

- **Enable SCTE 104/35:** Check this box to enable SCTE 104 extraction. Note that this control is only displayed if the input signal is SDI or if the encoder is in auto-detect video mode.

### ***SMPTE-2038 Generic ANC Transport***

If the input signal is SDI, the 9223-ENC is capable of extracting any generic (non-specific) ANC data (both from the VANC and the HANC) and inserting them into the output transport stream:

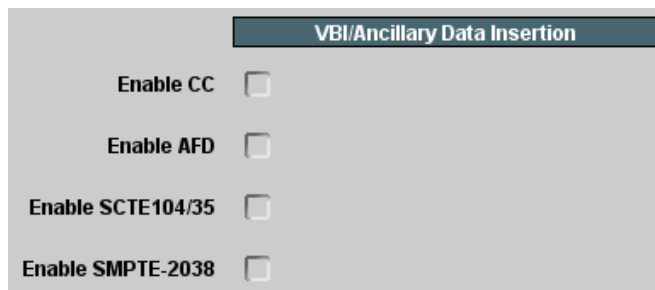

- **Enable SMPTE-2038:** Check this box to enable generic ANC extraction and insertion using SMPTE-2038. Note that this control is only displayed if the input signal is SDI or if the encoder is in auto-detect video mode. Once checked, the following additional controls are displayed:

Enable SMPTE-2038

SMPTE-2038 Config

Max Bit Rate (b/s)

Offset (frames)

Enable	DID	SDID
<input checked="" type="checkbox"/>	<input type="text" value="0x230"/>	<input type="text" value="0x230"/>
<input checked="" type="checkbox"/>	<input type="text" value="0x230"/>	<input type="text" value="0x131"/>
<input checked="" type="checkbox"/>	<input type="text" value="0x230"/>	<input type="text" value="0x132"/>
<input checked="" type="checkbox"/>	<input type="text" value="0x230"/>	<input type="text" value="0x233"/>

- Maximum Bit Rate (b/s):** Some types of ANC data, such as VITC or LTC, may use a non-trivial amount of bandwidth in the output. This parameter controls how much bandwidth to reserve in the transport stream output for ANC data, for NULL-padded CBR outputs. If the ANC data bit rate exceeds this value, packets may be dropped. For ANC data that appears only occasionally, a bit rate of zero may be specified. Note that the encoder measures the actual ANC rate in the transport stream and reports it in the **Status** tab (please refer to the Encoder Statistics section of this manual).
- Offset (frames):** The encoder will include information in the transport stream that enables the decoder to restore the ANC data to the exact same frame it came from. This control allows the encoder to offset this information to a range of -5 to +5 frames (i.e., the decoder will restore the ANC data to an earlier or later frame based on this setting). The default setting of 0 offset is recommended and will properly reinsert timecode into its corresponding SDI source frame.
- Enable/DID/SDID:** The encoder can support transport of up to 4 DID/SDID pairs per video input. They are specified here. Check the **Enable** box to enable a particular DID/SDID. Note that GUI shows the full 10-bit DID/SDID, but it accepts 8-bit entries as well. For example, the DID/SDID for VITC is 0x60/0x60 (8-bits). Simply enter “60”, and the encoder will compute the final 10-bit value (0x260) and display it. DID/SDID values are always entered in hexadecimal. The leading “0x” does not need to be entered, but will be automatically added by the encoder.

**Notes:**

- Only 4 DID/SDID pairs can be specified per video input. In a dual-channel encoder, both encoders can be configured to use the same input. In this case, the DID/SDID list will be common (i.e., changes made in one encoder tab will be immediately reflected in the other). The **Enable** controls, however, are specific to each encoder.
- The SMPTE-2038 feature is not available for SMPTE-334M Closed-Captioning, SMPTE-2016 AFD and SCTE-104 triggers, as there are well-defined standards for carriage of this information. Therefore, the following DID/SDID pairs will always be ignored if specified for SMPTE-2038 (even if the corresponding feature is disabled):

DID	SDID	Data Type
0x161	0x101	EIA 708 CC
0x161	0x102	EIA 608 CC
0x241	0x205	AFD
0x241	0x107	SCTE-104/SMPTE-2010

### Advanced Tab – Audio Parameters

The Audio Parameters are divided into three subgroups, some of which vary (and may not be present) according to the selections made in the Encoder Basic Configuration Tab. A sample of the Audio Parameters section is depicted below.

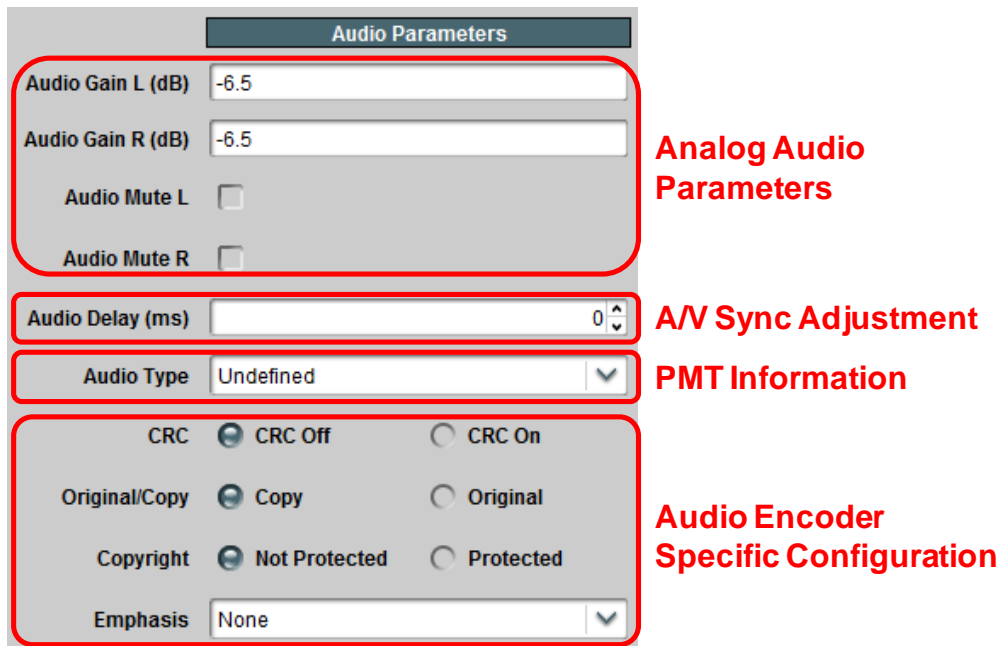

### Analog Audio Parameters

These parameters are only displayed if **Audio Source** in Basic Tab – Audio Configuration is set to **Analog Audio**. The parameters are:

- Balanced Audio Level:** This control is only displayed if the encoder is equipped with a balanced audio rear I/O panel. It selects the nominal signal level, as follows:
  - SMPTE:** Nominal level according to SMPTE RP155, typically used in North America.
  - EBU:** Nominal level according to EBU R68, typically used in Europe. The EBU level is 6 dB higher than the SMPTE level.
- Audio Gain L (dB), Audio Gain R (dB):** These controls allow an independent gain adjustment for the left/right audio channels, from -18.0 dB to +18.0 dB, in steps of 0.5 dB.



- 
- **Audio Mute L, Audio Mute R:** These controls allow muting of the left/right audio channels.

### *A/V Sync Adjustment*

This parameter can be used to provide a small amount of A/V sync adjustment, for cases where the A/V sync in the input signal to the encoder is not correct. If, in the input signal, audio is **behind** the video, you can use this parameter to compensate for up to 100 milliseconds. Note that it is only available for MPEG-1 Layer II and AAC-LC encoding; it will not be displayed for Dolby Passthrough.

- **Audio Delay (ms):** Use this to compensate for up to 100 milliseconds of audio delay in the input signal. This setting will advance the audio in relation to the video by the amount configured.

### *PMT Information*

The **Audio Type** control is always available. Its meaning is:

- **Audio Type:** determines the audio type in the PMT audio descriptor. This setting has no actual impact on how the audio is encoded; it only affects its description in the PMT. The choices are:
  - **Undefined:** no further information. This is the most common setting.
  - **Clean Effects:** indicates that the audio has no language.
  - **Hearing Impaired:** indicates that the audio is prepared for the hearing impaired.
  - **Visual Impaired Commentary:** indicates that the audio is prepared for the visually impaired viewer.

If the **Audio Encoding** setting in the Basic Tab – Audio Configuration is set to **Dolby Passthrough**, another parameter becomes available in the PMT Information section:

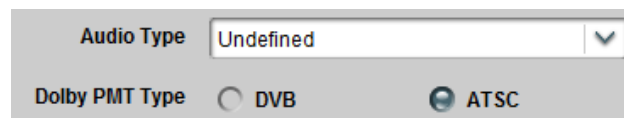

- **Dolby PMT Type:** this parameter controls how Dolby AC-3 audio is signaled in the PMT. The two choices are:
  - **DVB:** Dolby Audio is signaled as per ETSI TS 101 154 Appendix C (stream\_type 0x06 with the AC-3 Descriptor from EN 300 468 annex D).
  - **ATSC:** Dolby Audio is signaled as per ATSC A/53 Part 3 (stream\_type 0x81). However, the 9223-ENC is currently unable to generate the ATSC AC-3 Descriptor. If the Output Protocol in the Encoder Connections Tab is set to RTMP, the PMT Information fields will not be displayed as RTMP does not use the Transport Stream container.

---

If the Output Protocol in the Encoder Connections Tab is set to RTMP, the PMT Information fields will not be displayed as RTMP does not use the Transport Stream container.

### ***Audio Encoder Specific Configuration***

The appearance of this control depends on the **Audio Encoding** setting in the Basic Tab – Audio Configuration.

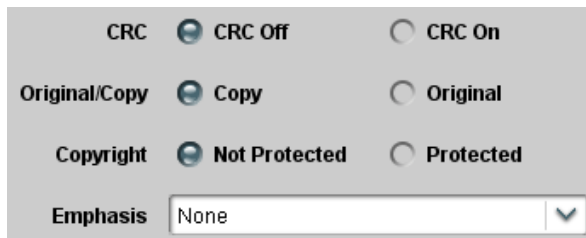

A screenshot of the MPEG-1 Layer II Configuration controls. It features four rows of settings: CRC (radio buttons for Off and On), Original/Copy (radio buttons for Copy and Original), Copyright (radio buttons for Not Protected and Protected), and Emphasis (a dropdown menu currently set to None).

**MPEG-1 Layer II Configuration**

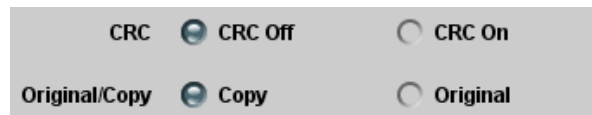

A screenshot of the AAC-LC Configuration controls, showing the same four rows of settings as the MPEG-1 configuration: CRC (radio buttons for Off and On), Original/Copy (radio buttons for Copy and Original), Copyright (radio buttons for Not Protected and Protected), and Emphasis (a dropdown menu currently set to None).

**AAC-LC Configuration**

The parameters are:

- **CRC:** Enables/Disables CRC insertion in the audio elementary stream. This is normally left disabled (CRC off).
- **Original/Copy:** Controls the state of the Original/Copy flag in the audio elementary stream. This setting does not affect the actual audio encoding.
- **Copyright:** Controls the state of the Copyright flag in the audio elementary stream. This setting does not affect the actual audio encoding.
- **Emphasis:** Controls the state of the Emphasis flags in the audio elementary stream. This setting does not affect the actual audio encoding. The available values are **None**, **50/15 us**, and **ITU-T J.17**.

### **Advanced Tab – Additional Audio Channels**

When **Secondary Audio** is set to **Enabled**, or Additional Audio Channels are enabled, the following changes take place:

- Additional sets of controls are displayed in the Encoder Advanced Tab, corresponding to each of the enabled audio channels. Each set operates independently as described in the previous section.
- If **Secondary Audio** is set to Enabled, no Advanced Audio controls are displayed in the Advanced Tab for Encoder 2.

The example below illustrates the Advanced Audio controls when one additional audio is enabled. In this example, Audio Channel 1 is set to MPEG-1 Layer II, from the analog input, and Audio Channel 2 is set to Dolby Passthrough.

---

**Audio Channel 1**

Audio Gain L (dB)

Audio Gain R (dB)

Audio Mute L

Audio Mute R

Audio Delay (ms)

Audio Type

CRC  CRC Off  CRC On

Original/Copy  Copy  Original

Copyright  Not Protected  Protected

Emphasis

**Audio Channel 2**

Audio Type

Dolby PMT Type  DVB  ATSC

### Advanced Tab – Mux Parameters

These parameters control the details of the audio/video multiplexing, and the (P)SI tables. If the Output Protocol in the Encoder Connections Tab is set to RTMP, these parameters will not be shown as RTMP does not use the Transport Stream container.

The following Mux Parameters are always available if the Output Protocol is not set to RTMP:

**Mux Parameters**

PMT PID

PCR PID

Video PID

Audio PID

SCTE 35 PID

SMPTE 2038 PID

Program Number

Transport Stream ID

Generate SDT

- PMT PID, PCR PID, Video PID, Audio PID, SCTE 35 PID, SMPTE 2038 PID:**  
 These parameters control the Packet Identifier (PID) values for the PMT, PCR, Video, and Audio, and the various ancillary data formats. The values can be entered in hexadecimal (prefixed by 0x) or in decimal. Valid values are from 0x20 (32) to 0x1FFE (8190). PMT PID, Video PID and Audio PID must be distinct values. PCR PID can either be the same as the video PID or distinct from the other values as well. The user interface will not accept an invalid entry at any time – it will immediately revert to the previous value. If additional audio channels are enabled, there will be additional entries for their corresponding PIDs. The SCTE 35 PID entry is shown only if SCTE 104 Ad Insertion Triggers are enabled. The SMPTE-2038 PID entry is shown only if the feature is enabled.
- Program Number:** Enter the desired program number for this encoder channel. Valid program numbers go from 1 to 65535 and are always entered in decimal.
- Transport Stream ID:** Enter the desired Transport Stream ID for this encoder channel. Values in this field can be entered both in hexadecimal (prefixed by 0x) or in decimal.
- Generate SDT:** This box is always shown but is not selectable for the HTTP Live Streaming and RTMP protocols. If this box is checked, an SDT will be generated for this encoder channel. Additional SDT parameters become available once this box is checked, as depicted below.

The screenshot shows a configuration panel with the following elements:

- Generate SDT:** A checkbox that is checked.
- Service Name:** A text input field containing the text "Slot 5 Encoder 1".
- Provider Name:** A text input field containing the text "MVN".
- Advanced SDT Config:** A checkbox that is unchecked.

- Service Name:** Enter the desired SDT service name for this encoder channel. The default name is **Slot X Encoder Y**, where **X** is the openGear® slot number where the 9223-ENC is installed, and **Y** is 1 or 2 (for Encoder 1 or Encoder 2).
- Provider Name:** Enter the desired SDT service provider name. The default is **Cobalt Digital Inc.**
- Advanced SDT Config:** By default, the other SDT values are automatically set by the system. If you need to configure them, check this box, and a new set of parameters appears, as shown below.

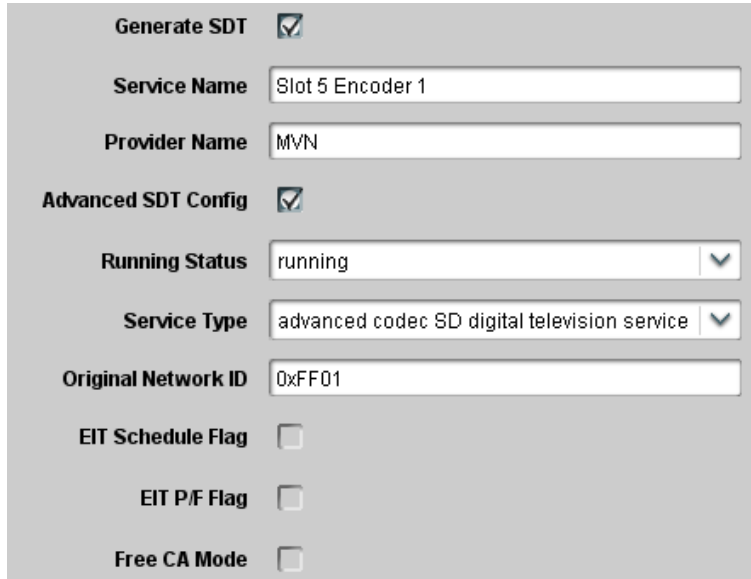

- **Running Status:** Indicates the status of the service. The options are **undefined, not running, starting, pausing, running,** and **service off-air**. The value used for this parameter when **Advanced SDT Config** is not enabled is running.
- **Service Type:** Indicates the type of service. The value used for this parameter when **Advanced SDT Config** is not enabled is advanced codec SD digital television service if the encoder is in SD mode, or advanced codec HD digital television service if the encoder is in HD mode. The drop-down list offers a few of the most common choices. If you need to code something other than these choices, select **custom setting** in the drop-down list and a new parameter will become available, as show below.

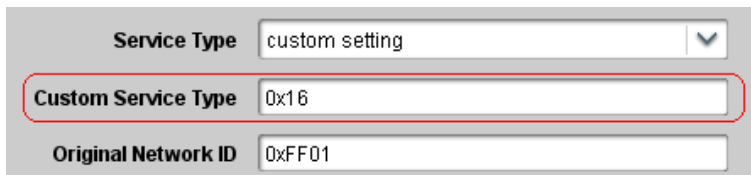

- **Custom Service Type:** Enter the service type. This field accepts both hexadecimal (prefixed by 0x) and decimal values. The valid range is from 0 (0x00) to 255 (0xFF).
- **Original Network ID:** This field contains the Network ID code from which this program originated. This field accepts both hexadecimal (prefixed by 0x) and decimal values. Valid values are from 0 (0x0000) to 65535 (0xFFFF). The default value for this field is 0xFF01, which is in the range of values allocated for video over IP. The complete set of registered Network IDs can be downloaded from this URL:

[http://www.dvbservices.com/identifiers/export/original\\_network\\_id](http://www.dvbservices.com/identifiers/export/original_network_id)

- **EIT Schedule Flag:** Check this box to set the flag. This flag indicates that EIT schedule information is present for this service. Since the 9223-ENC does not generate EITs, the correct setting of this flag is not set. Only set it if you intend to mux an EIT downstream of the 9223-ENC.

- **EIT P/F Flag:** Check this box to set the EIT present/following flag for this service. Since the 9223-ENC does not generate EITs, the correct setting of this flag is not set. Only set it if you intend to mux an EIT downstream of the 9223-ENC.
- **Free CA Mode:** Check this box to set the Free CA Mode flag. If this flag is set, it indicates that one or more components of the service are scrambled. Since the 9223-ENC does not offer scrambling, the correct setting of this flag is not set. Only set it if you intend to scramble the program downstream from the 9223-ENC.

## Encoder Connections Tab

The Connections Tab is used to create output connections for the encoder. The set of output options offered is a function of whether or not Secondary Audio and/or Additional Audio are enabled:

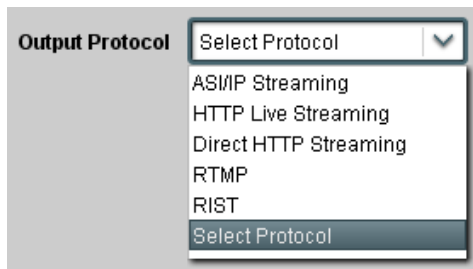

**Secondary/Additional Audio Disabled**

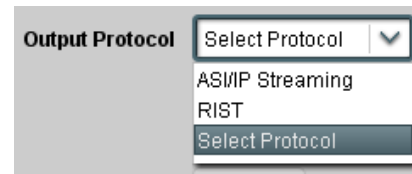

**Secondary/Additional Audio Enabled**

The options are:

- **ASI/IP Streaming:** the output of the encoder is available for connections to ASI Outputs and IP Outputs, as described later in this manual.
- **HTTP Live Streaming:** the output of the encoder is directed to a web server (which can be the internal server in the encoder or an external server), which in turn serves it to web clients using HTTP Live Streaming. If this option is selected, the encoder output is not available to ASI and IP Output ports, and the video bit rate is limited to 15 Mb/s. Moreover, the **GOP Mode** parameter in the Advanced Tab – Video Parameters tab will be forced to **Closed GOP**. This output option is not available if Secondary Audio is enabled.
- **Direct HTTP Streaming:** the output of the encoder is available to clients over a standard HTTP connection. Clients will open an HTTP connection to the encoder, send a standard HTTP GET request, and receive the bitstream (for as long as they keep the connection open). This output option is not available if Secondary Audio is enabled.
- **RTMP:** the encoder will operate as an RTMP client, connect to a specified RTMP server and publish the stream, similar to the Adobe Flash® Live Media Encoder (FMLE). If this is selected, the **GOP Mode** parameter in the Advanced Tab – Video Parameters will be forced to **Closed GOP**. This output option is not available if Secondary Audio is enabled.
- **RIST:** the encoder will transmit RTP streams, and will accept retransmission requests (ARQ) as per VSF TR-06-1.

---

Once an option is selected, the appropriate configuration parameters are displayed.

## ASI/IP Streaming

If this option is selected, the standard Output Selection Connection Parameters are presented. These connection parameters are common to all data sources, and are described later in the Destination Selection section in the Connections chapter of this document.

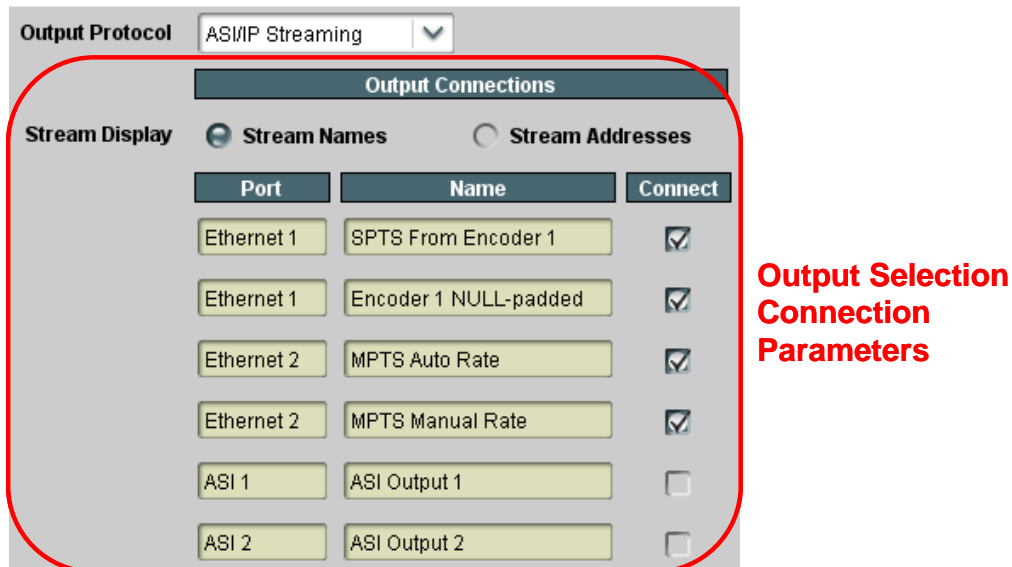

## HTTP Live Streaming

HTTP Live Streaming is a protocol designed to deliver live streaming content to clients on the Internet using a standard unmodified Web Server and the standard HTTP protocol.

The highlights of the protocol are:

- The encoder segments the bitstream into small files of similar duration, at some suitable points.
- The encoder continuously uploads the files as they are created to a standard web server.
- Every time the encoder uploads a new file, it also updates a special playlist file in the server, which informs the clients of which segments are available.
- The encoder also takes care of deleting old files from the server.
- The clients can connect to the web server at will; they download the playlist file, and start playing the segments as they come.
- A standard unmodified web server can be used.

---

A typical use case is depicted below.

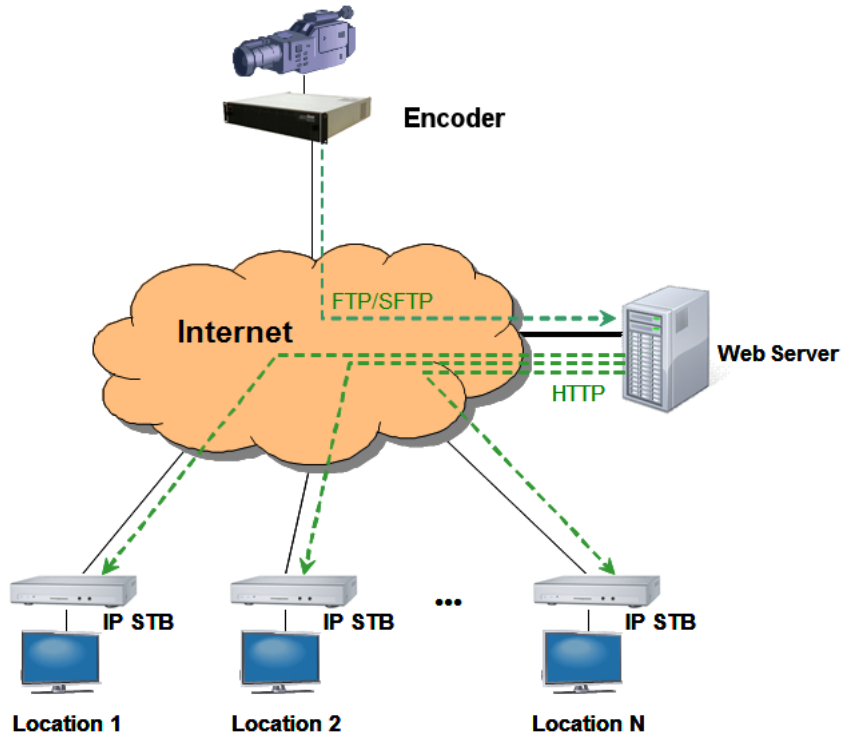

HTTP Live Streaming is supported in the 9223-ENC. The content can be uploaded to an external server, or served directly from the unit.

### *HLS Common Parameters*

The picture below shows the HLS parameters that are common to all modes:

- **Server Location:** selecting **Remote** configures the encoder to upload the segment and manifest files to a remote server. Selecting **Local** configures the encoder to place the segments in its local web server, where they are directly-accessible to clients.
- **Segment (sec):** Number of seconds per segment. This defines the approximate size (in seconds) for the above bitstream encoded files. The valid range is from 1 to 20 seconds. Note that the clients will experience latency approximately equal to the segment size times the number of segments.
- **Number of Segments:** This defines the number of bitstream segments advertised in the playlist. The minimum number, as per the HLS specification, is 3. Some set-top boxes require 4 segments. Apple devices (iPads, iPods, etc.) work well with 3 segments.
- **Program Name:** this is the program name that goes in the manifest. Most HLS clients ignore this information.



Output Protocol: HLS

Server Location:  Remote  Local

Segment (sec): 2

Number of Segments:  3  4  5

Program Name: Encoder 1 Program

### ***HLS Local Server***

No additional configuration options are required for HLS Local Server. The access URLs for the content are:

```
http://xxx.xxx.xxx.xxx/HLS/encoder1.m3u8
http://xxx.xxx.xxx.xxx/HLS/encoder2.m3u8
```

where **xxx.xxx.xxx.xxx** is the IP Address of the device Ethernet port. In the 9223 openGear® version, HLS streams are available through both streaming Ethernet ports. In the BBG-1123-ENC/9223-SA, in addition to the streaming Ethernet ports, HLS content can also be accessed from the control port. Also note that if you use a browser to go to the encoder IP address (i.e., just go to **http://xxx.xxx.xxx.xxx**), there will be a link for the HLS page.

### ***HLS Remote Server–FTP or SFTP Transfer***

The specific parameters for this mode are:

- **Transfer Protocol:** This configures the protocol to be used between the encoder and the web server for uploading the files. The two options covered in this section are **FTP** and **SFTP** (Secure FTP). FTP exchanges data and password in the clear, while SFTP encrypts both flows.
- **Server Address:** Enter the IP address of the web server here. It needs to be reachable from either one of the encoder Ethernet ports.
- **Username:** Enter the username to be used when uploading the files to the server.
- **Password:** Enter the password corresponding to the user name, to be used when uploading the files.
- **Server Path:** Enter the absolute server path for the directory where the files should be placed. It is recommended that a separate directory be created for each encoder channel.
- **Base File Name:** Enter the base file name for the files created in the server. The encoder will create the following files:
  - **basename.m3u8:** This is the top playlist file. For the example above, where the base file name is **live**, the playlist file will be **live.m3u8**. This file will contain a single bit rate profile. It is created when the encoder starts, and not changed during operation. For backward compatibility with previous versions, a top playlist with an **.m3u** extension and identical contents will also be created.
  - **basename\_p.m3u8:** This is the current playlist file for the encoder profile. It is updated every time a new segment is created.

- **basename\_XXXX.ts:** These will be the bitstream encoded files. XXXX is an increasing count. For the example above, the encoder will create files named **live\_1.ts, live\_2.ts, live\_3.ts, live\_4.ts**, and so on. At any given point in time, there will be five or six consecutive files in the configured directory if the encoder is configured to remove older files.
- **Extra Server Compatibility:** Check this box if the encoder has problems renaming files in the server. This is typically required for Windows FTP servers. Linux-based servers do not need this.
- **Keep Segments on Server:** Normally, when a segment falls out of the playlist file, it is automatically deleted by the encoder. If you check this box, the bitstream is left in the server. Clients will still start playing from the first segment in the playlist.

Server Location  Remote  Local

Transfer Protocol  FTP  SFTP  HTTP/S

Server Address

Username

Password

Server Path

Base File Name

Segment (sec)

Number of Segments  3  4  5

Extra Server Compatibility

Keep Segments on Server

### ***HLS Remote Server–HTTP/HTTPS Transfer***

This mode uses HTTP PUT to transfer files to an HTTP server. The specific parameters for this mode are:

Server Location  Remote  Local

Transfer Protocol  FTP  SFTP  HTTP/S

Upload URL

Enable Host Header

Base File Name

- **Upload URL:** this is the base URL to be used to upload the segment and manifest files. The encoder supports both **http://** and **https://** URLs. Host names can be used if the

---

encoder is configured with a DNS server (see the Network Configuration DNS Tab). Note that, for **https://** URLs, the encoder **will not** authenticate the server – the protocol is being used to provide only encryption, not authentication.

- **Enable Host Header:** if this box is checked, the encoder will send an HTTP host header with each request. A new field will be presented here the contents of the host header can be entered:

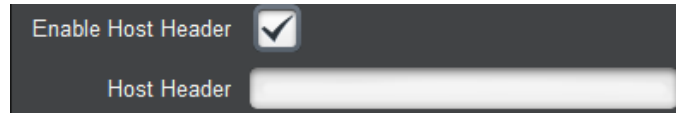

- **Base File Name:** this field is the same as in HLS Remote Server–FTP or SFTP Transfer, and the same files will be transferred. The final HTTP URL will be the concatenation of the **Upload URL** field, the base file name, and the extensions described above.

### *HLS Implementation Notes*

- When HTTP Live Streaming is selected, the **GOP Mode** control is set to **Closed GOP** and is not selectable. This is done to ensure that each segment is self-contained.
- The maximum video bit rate allowed in HLS mode is 15 Mb/s.
- The maximum aggregate performance of the built-in HLS server in the 9223-ENC is between **20 and 30 Mb/s** (total bit rate to all clients), and is somewhat dependent on network conditions. The built-in server is intended to serve only a small handful of clients and performance is **not guaranteed** at the capacity limits; if you need to scale, please use a remote server.
- If you are streaming to Apple devices such as iPhones, iPads or iPods, you must also select the following:
  - **Audio Encoding:** Select **AAC-LC**.
  - **Output Resolution:** If you are streaming to older Apple devices, select one of the resolutions ending in **/15p** (e.g., 320x240/15p). If your input is PAL, these resolutions will be shown ending in **/12.5p**. Newer devices may be able to support higher resolutions.

### **Direct HTTP Streaming**

Direct HTTP Streaming is an output mode whereby clients open a standard HTTP connection to the 9223-ENC and issue a standard HTTP GET request. The 9223-ENC will send the appropriate HTTP response followed by the encoder bitstream; the bitstream will be transmitted for as long as the client maintains the connection. Since HTTP runs on top of the TCP protocol, it is possible for the 9223-ENC to deliver content over the Internet using this mode. However, it has the following limitations:

- The 9223-ENC has to send one independent copy of the bitstream to each client. There is a limit of 5 clients or 20 Mb/s per Ethernet port in this mode.

- 
- The TCP protocol is capable of flow control; if the client is not fast enough, or if the network between the 9223-ENC and the client is not fast enough, the protocol will attempt to throttle the encoder, which is not possible. The 9223-ENC will buffer a small amount of bitstream in this case, but if the overall performance of the client/network link combination is insufficient to support the configured encoder data rate, the 9223-ENC will drop transport packets.

Direct HTTP Streaming has one single parameter:

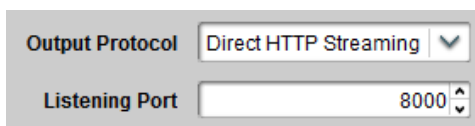

The screenshot shows a configuration panel with two fields. The first field is labeled 'Output Protocol' and has a dropdown menu with 'Direct HTTP Streaming' selected. The second field is labeled 'Listening Port' and has a numeric input field with '8000' entered.

- **Listening Port:** Use this to select the TCP port to be used by the 9223-ENC to listen to HTTP connections. Please note that the 9223-ENC will not accept the values 22, 23 and 80<sup>3</sup> for this parameter. The listening ports for Encoders 1 and 2 can be set independently (and can be set to the same value if desired).

The URL for accessing the bitstream will be:

**http://encoder\_ip:port/encoder1** (access to encoder1)  
or  
**http://encoder\_ip:port/encoder2** (access to encoder2)

Where **encoder\_ip** is the IP address of either one of the 9223-ENC Ethernet ports (configured in the Network Tab) and **port** is the Listening Port configured above. For example, if one of the IP addresses of the 9223-ENC is set to 10.10.9.80, and the Listening Port is set to 8000 (as shown above), the URL for Encoder 1 will be:

**http://10.10.9.80:8000/encoder1**

Please note that none of the common web browsers (Explorer, Firefox, etc) are capable of directly playing this URL; what these browsers will do is download the bitstream to a file. If you wish to see video playback on a web page, please review the “Playing Video on a Web Page” section later in this document.

## RTMP

The 9223-ENC can operate as an RTMP client, and publish a real-time, live bitstream to an RTMP server. RTMP clients (such as the Adobe® Flash® Player) can connect to the server and play the live stream. The 9223-ENC can generally connect to the same servers as the Adobe Flash Live Media Encoder (FMLE).

An RTMP server publishing point is defined by the following:

---

<sup>3</sup> The BBG-1123-ENC has an internal Web Server running on port 80.

- An RTMP URL, of the form:

**rtmp[t][e][s]://servername/app**

- A stream name

The first part of the URL defines the protocol, as follows:

- **rtmp**: standard RTMP with no security
- **rtmpt**: RTMP tunneled over HTTP
- **rtmpe**: encrypted RTMP using proprietary security
- **rtmps**: encrypted RTMP over SSL
- **rtmpte**: encrypted RTMP using proprietary security, tunneled over HTTP
- **rtmpts**: encrypted RTMP over SSL, tunneled over HTTP

The **servername** field is the host name or IP address of the RTMP server to be contacted. The **app** field is the application in the server that should receive the data being transmitted. Note that, depending on the service, the **app** field may contain a complete path or even a set of parameters.

The 9223-ENC encoder can be configured with primary/backup RTMP servers. If it cannot connect to the primary server, it will automatically try the backup.

The RTMP configurable parameters are:

The screenshot displays a configuration interface for RTMP servers. It is organized into three main sections: Primary Server, Backup Server, and Common Parameters.

- Primary Server Section:**
  - Output Protocol:
  - RTMP Protocol:
  - Primary Server:
  - Primary Network Interface:  Any,  Ethernet 1,  Ethernet 2
  - Primary App:
  - Primary Server URL:
  - Primary Stream:
- Backup Server Section:**
  - Backup Server:
  - Backup Network Interface:  Any,  Ethernet 1,  Ethernet 2
  - Backup App:
  - Backup Server URL:
  - Backup Stream:
- Common Parameters Section:**
  - Redundancy Switch Time (sec):
  - Port Selection:  Use Default,  Specific Port
  - Authentication:  Yes,  No
  - Connect:  Yes,  No

- 
- **RTMP Protocol:** Select the protocol variant, as discussed above.
  - **Primary Server:** Enter the host name or IP address of the primary (or single) RTMP server to be contacted. If you want to use host names instead of IP addresses, make sure to configure at least one DNS server.
  - **Primary Network Interface:** Select the network interface to be used when contacting the primary server. The settings are:
    - **Any:** use the “best” network interface to connect to the server. In the 9223-ENC, this setting allows the encoder to use the control Ethernet port to connect to the RTMP server, if appropriate.
    - **Ethernet 1:** preferably use Ethernet 1 to connect to the server. If the server is not in the same subnet as Ethernet 1, and no default gateway is set for Ethernet 1, this setting will be ignored.
    - **Ethernet 2:** preferably use Ethernet 2 to connect to the server. If the server is not in the same subnet as Ethernet 2, and no default gateway is set for Ethernet 2, this setting will be ignored.
  - **Primary App:** Enter the application name in the primary server, as discussed above. Consult your CDN or server documentation to find out what should be entered in this field.
  - **Primary Server URL:** This informational field is automatically updated as you configure the RTMP parameters. It displays the full RTMP URL for the primary server.
  - **Primary Stream:** Enter the stream name for the primary server. Consult your server documentation or CDN to find out what should be entered here. Some servers allow arbitrary stream names, while others use this field for authentication and thus require specific names.
  - **Backup Server:** If you have a backup RTMP server, configure it here; otherwise, this field can be left empty. The encoder will only attempt to contact the backup RTMP server if it cannot establish a connection with the primary server.
  - **Backup Network Interface:** Select the network interface to be used when contacting the backup server. The meaning of the choices is the same as the **Primary Network Interface** described above.
  - **Backup App:** Enter the application name in the backup server. If this field is left blank, the value entered for **Primary App** is used.
  - **Backup Server URL:** This informational field is automatically updated as you configure the RTMP parameters. It displays the full RTMP URL for the backup server.
  - **Backup Stream:** Enter the stream name for the backup server. If this field is left blank, the value entered for **Primary Stream** is used.
  - **Redundancy Switch Time (sec):** This field is only displayed if a **Backup Server** is specified (i.e., it will not be present if **Backup Server** is left blank). It sets the timeout for encoder to switch servers after the RTMP connection is established, if the server stops accepting data (i.e., when the **IP Output Rate** goes to zero).
  - **Port Selection:** If your RTMP server is using the default TCP ports for the protocol variant, select **Use Default**. If your server is using a non-standard port, select **Specific Port**. When **Specific Port** is selected, an additional field is displayed:

The screenshot shows a configuration window titled "Common Parameters". It contains the following settings:

- Port Selection:**  Use Default,  Specific Port
- Port:** A text field containing the value "1935".
- Authentication:**  Yes,  No

- **Port:** This field is only displayed if **Port Selection** is set to **Specific Port**. Configure a non-standard TCP port here.
- **Authentication:** Some RTMP servers require username/password authentication for access. If your server does not require authentication, select **No**, otherwise select **Yes**. If you select **Yes**, additional fields are presented:

This screenshot shows the configuration window with authentication fields enabled:

- Port Selection:**  Use Default,  Specific Port
- Authentication:**  Yes,  No
- Username:** A text field containing the value "streamer".
- Password:** A text field with six black dots representing a masked password.
- Connect:**  Yes,  No

- **Username:** Enter the username to be used for authentication.
- **Password:** Enter the password to be used for authentication.
- **Connect:** This parameter controls whether or not the encoder should actually establish a connection with the server. If you set this parameter to **No**, the encoder will run but no data will be transmitted. This is useful to pre-configure a session, and turn it on later when it comes the time to broadcast.

**Notes:**

- The maximum aggregate RTMP performance for the 9223-ENC is **12 Mb/s**. If the unit has two encoder channels, this limit applies to the sum of their video bit rates. For example, if one encoder channel is configured for RTMP at 8 Mb/s, the other can only be configured for RTMP at 4 Mb/s or less. The limit does not apply to encoder channels configured for UDP/RTP/ASI streaming.
- Using one of the encrypted variants of the protocol (**rtmpe**, **rtmps**, **rtmpte**, or **rtmpts**) will also have a performance impact and will reduce the maximum usable rate.
- Performing a firmware update while the encoder is running RTMP at high bit rates may cause service interruptions to the RTMP stream. If you need to update the firmware, we recommend that you do so during a maintenance window.
- Some CDNs (such as YouTube, for example) only accept frame rates up to 30 fps and prefer progressive content. The 9223-ENC can convert any input signal to progressive at a lower bit rate.
- In RTMP Mode, the 9223-ENC will force Closed GOP operation as required by some CDNs.

## RIST

The figure below shows the output tab when RIST is selected. In this mode, up to four copies of each stream can be sent by the encoder. The parameters are:

The screenshot shows the RIST configuration interface. At the top, the Output Protocol is set to RIST. Below this are several settings: Drop NULL Packets (unchecked), NACK Window (ms) set to 2500, Transmission Mode set to Independent Destinations (selected), and Limit Retrans Rate (unchecked). Below these settings is a table titled 'Stream Destinations' with columns for Enable, Destination, UDP Port, Interface, TTL, and TOS. The table contains four rows for Stream 1 through Stream 4, each with its own settings. Below the table are 'Apply' and 'Cancel' buttons.

Stream Destinations					
Enable	Destination	UDP Port	Interface	TTL	TOS
<input type="checkbox"/>	225.1.1.1	2000	Eth1	128	0
<input type="checkbox"/>	225.1.1.2	2002	Eth1	128	0
<input type="checkbox"/>	225.1.1.3	2004	Eth1	128	0
<input type="checkbox"/>	225.1.1.4	2006	Eth1	128	0

- **Drop Null Packets:** check this box to remove the NULL packets from the output. Note that most professional-grade IRDs require NULL packets. The professional decoders from Cobalt Digital can operate without NULL packets.
- **NACK Window (ms):** specify how long the encoder should buffer transmitted packets in expectation of retransmission requests. The exact number does not matter much; a value in the order of 5000 milliseconds should cover most cases.
- **Transmission Mode:** this parameter controls how the encoder handles multiple destinations. The options are:
  - **Independent Destinations:** The encoder treats each destination enabled under **Stream Destinations** as an independent receiver. Retransmission requests will be independently handled per destination.
  - **Replicated Streams:** The encoder assumes that it is sending multiple copies of the stream to the same receiver, to implement SMPTE-2022-7 Seamless Switching. Retransmissions may not be sent over the same destinations as the requests.
  - **Bonded Streams:** The encoder splits the streams equally over the configured destinations. For example, if there are three destinations, each will get 1/3 of the packets. It is assumed that all destinations correspond to the same receiver, and the receiver will re-order the packets prior to consuming them.
- **Limit Retrans Rate:** if this box is checked, the retransmission rate is limited. A new parameter becomes available, where the maximum retransmission rate can be entered.

A close-up of the 'Limit Retrans Rate' setting. The checkbox is checked, and the 'Max Retrans Rate (b/s)' is set to 2000000.



---

**Stream Destinations:** up to 4 stream destinations can be configured. They will all receive the same content and share the same NACK window if RIST is enabled. The destination parameters are:

- **Enable:** check this box to enable transmission to this particular destination.
- **Destination:** enter the destination IP address.
- **UDP Port:** enter the destination UDP port. This UDP port must be an even number. Odd numbers will not be accepted in the GUI.
- **Interface:** select the desired streaming interface. RIST tunnels defined in the Network Configuration RIST Tunnels Tab can also be selected here.
- **TTL:** select the desired Time-To-Live for the packets. The TTL value specifies how many routers the packet can cross before being dropped.
- **TOS:** enter the value of the Type-Of-Service (TOS) field in the IP header, if desired, between 0 and 255. The upper 6 bits of field are also known as the DSCP (Differentiated Services Code Point). Note that setting this field will have no effect on the traffic QoS unless the routers in the path are configured to honor the value.

**Note:** This feature can work in conjunction with secondary audio and ancillary data transfer (such as SMPTE-2038 function).

**Note:** If selected video bit rate (as set on Encoder **Basic** sub-tab) is too high for RIST, the message shown below will appear.

	Enable	Destination	UDP Port
Stream 1	<input checked="" type="checkbox"/>	225.1.2.1	9910
Stream 2	<input checked="" type="checkbox"/>	225.1.2.2	2102
Stream 3	<input checked="" type="checkbox"/>	225.1.2.3	2104
Stream 4	<input checked="" type="checkbox"/>	225.1.2.4	2106

**Video Rate too high for RIST operation**

Apply  
Cancel

---

## The Apply/Cancel Buttons

The **Apply/Cancel** buttons are available at the bottom of the **Basic**, **Advanced**, and **Connection** screens. These are not separate buttons – they are multiple instances of the same buttons, repeated on each screen for convenience. If no changes have been made to the settings, the **Apply/Cancel** buttons are grayed out; once any changes are made, they become available. Changes do not take effect until the **Apply** button is pressed. If you make changes but decide not to apply them, click on the **Cancel** button and the user interface reverts to where it was before. Once you click on the **Apply** button, the changes are implemented.



In general, most changes will cause the encoder channel to stop and start again, causing a brief (2-second) interruption to the stream. Changes to the following parameters are implemented on-the-fly, without stopping the encoder:

- Audio Source in Basic Tab – Audio Configuration
- Language Code in Basic Tab – Audio Configuration
- Any CC/AFD configurations made.
- Audio Gain L/R in Analog Audio Parameters
- Audio Mute L/R in Analog Audio Parameters
- Audio Type and Dolby PMT Type in PMT Information.

## Encoder Statistics Tab

The Encoder Statistics Tab is divided into four lower tabs, as indicated below:

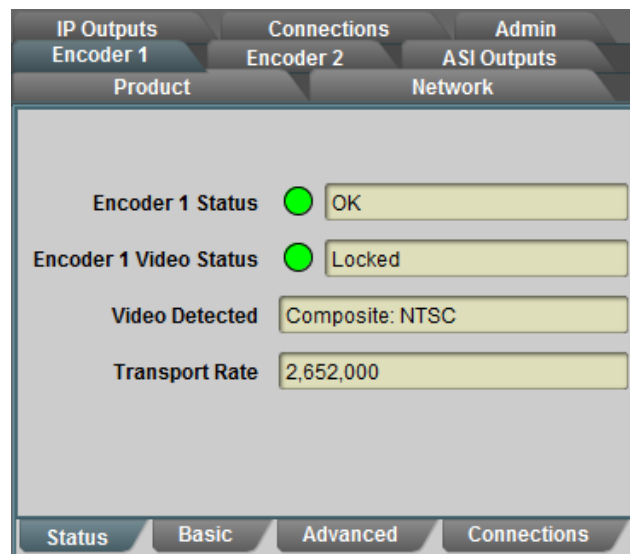

The **Basic**, **Advanced** and **Connections** tabs are direct equivalents of their configuration counterparts. They present the current value of each of the configuration parameters. When the **Apply/Cancel** buttons are grayed out, the contents of these tabs exactly match their configuration counterparts. When the **Apply/Cancel** buttons are active, configuration parameters have been changed. The current (running) encoder configuration can still be inspected in the statistics tabs, prior to clicking on the **Apply** button.

The **Status** Tab provides a summary of the current status of the encoder. It is divided into two areas, the **Encoder Status** area and the **Output Status** area. The Encoder Status area reflects the current status of the encoding subsystem, and the Output Status area reflects the status of the network output subsystem. Both areas change depending on the individual subsystem settings.

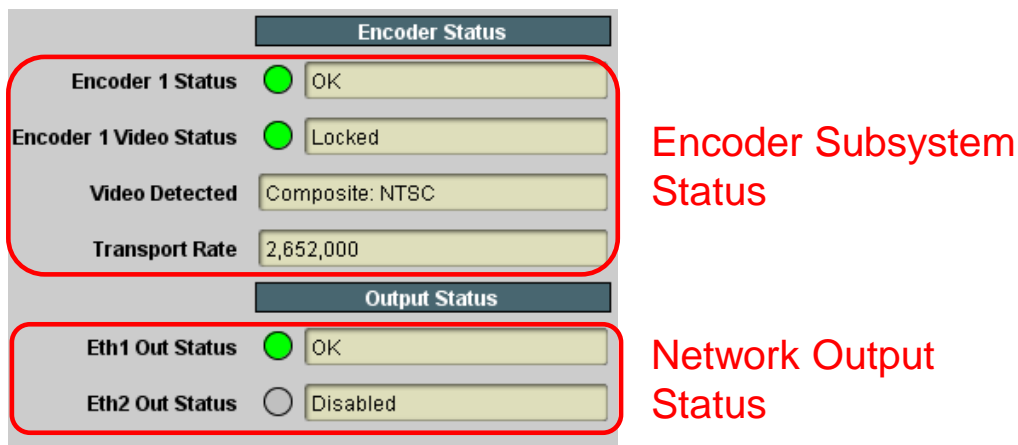

## Encoder Status

The variables displayed in the Encoder Status area vary according to the encoder configuration, but the following four basic parameters are always displayed:

- **Encoder 1/2 Status:** This gives the overall encoder status. Its values are:
  - **OK:** The encoder is running normally.
  - **Stopped:** The encoder has been manually stopped (see **Encoder State** in Basic Tab – General Configuration).
  - **Error:** The encoder should be running but it is not. This status will be briefly shown when the encoder is starting. The possible causes for this are:
    - The encoder has no input (check **Encoder 1/2 Video Status**)
    - There is a mismatch between the video input signal and the encoder configuration. For example, the input is 1080i and the encoder is configured for 720p.
- **Encoder 1/2 Video Status:** This indicates whether or not the selected video input front-end is locked. This status is also reflected in the rear I/O panel LED next to the video input. The possible values are:
  - **Locked:** The selected video input front-end is locked.
  - **Unlocked:** The selected video input front-end is unlocked.

- Video Detected:** If there is any recognizable video signal at the encoder video input, this field will indicate what type of signal the encoder is detecting. This detection is independent of the video input settings and is intended to aid the operator in making the correct selection. If a video signal is detected, the text in this field will either start with the word **Composite** (if an analog composite video signal is detected), or **SDI** (if a digital SDI signal is detected). If no recognizable video signal is detected, this field will indicate **No signal**. For the detected video signals, the encoder will provide further information on the type of signal, as follows:
  - For **Composite** signals, the encoder will further report the encoding system, as follows:
    - Systems with 59.94 fields/sec: **NTSC, NTSC 4.43, PAL-M**
    - Systems with 50 fields/sec: **PAL B/D/G/H/I/N, PAL-Nc, SECAM**
  - For **SDI** signals, the encoder will indicate additional information, as follows:
    - For Standard Definition signals, this field will report **SDI: SD**.
    - For High Definition signals, this field will report resolution, frame/field rate, and whether the signal is progressive or interlaced. Examples:
      - SDI: 1920x1080i59.94**
      - SDI: 1280x720p50**
    - For High Definition signals whose resolution is not 1920x1080 or 1280x720, the encoder will report the input as **SDI: unknown**. Encoding of such signals is not supported by the 9223-ENC.
- Transport Rate:** This indicates the overall transport rate, including NULL packets (which are not actually transmitted), coming out of the encoder subsystem. The actual rate will be lower than this by about 5%.

If Closed Captions are enabled, the encoder reports whether or not it is receiving them:

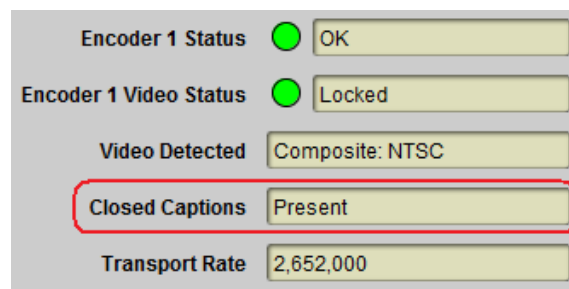

- Closed Captions:** This reports Closed Caption insertion. This field will report **Present** or **Not Present**. If Closed Captions are reported as **Not Present**, the possible reasons are:
  - If the caption source is EIA-608 Line 21, it means that the encoder cannot find a valid closed caption waveform on that line.
  - If the caption source is SMPTE-334 VANC, it means that the encoder is either not receiving closed caption messages, or it is receiving EIA-708 messages without a caption field.

Note that it is possible for the encoder to be receiving closed caption data that is empty (without actual captions). These will be reported as **Present**.

---

If AFD insertion is enabled, the encoder reports whether or not it is receiving them, and what AFD code is being inserted:

The screenshot shows a control panel with the following fields: Encoder 1 Status (OK), Encoder 1 Video Status (Locked), Video Detected (Composite: NTSC), Closed Captions (Present), AFD (Code 1000), and Transport Rate (2,652,000). The AFD field is highlighted with a red rectangle.

- **AFD:** This reports AFD insertion. This field will report either **Not Present** (if no AFD is being received) or **Code XXXX**, if AFD is being received; XXXX is the current AFD code being inserted. If AFD Source is set to Manual AFD Selection, this field will report the selected manual code.

If the input is SDI, the encoder reports the detected type of SDI signal:

The screenshot shows a control panel with the following fields: Encoder 1 Status (OK), Encoder 1 Video Status (Locked), Video Detected (SDI: 1920x1080i59.94), SDI Standard (HD SDI), and Transport Rate (6,942,000). The SDI Standard field is highlighted with a red rectangle.

- **SDI Standard:** this indicator reports the detected SDI signal. Possible values are **unlocked**, **SD SDI**, **HD SDI** and **3G SDI**. This is useful to resolve SDI signal mismatch issues (for example, when the input signal is SD SDI and the encoder is configured for HD).

---

If the input is SDI and the **Audio Source** parameter in Basic Tab – Audio Configuration is set to **SDI Embedded Audio**, two more indicators are shown:

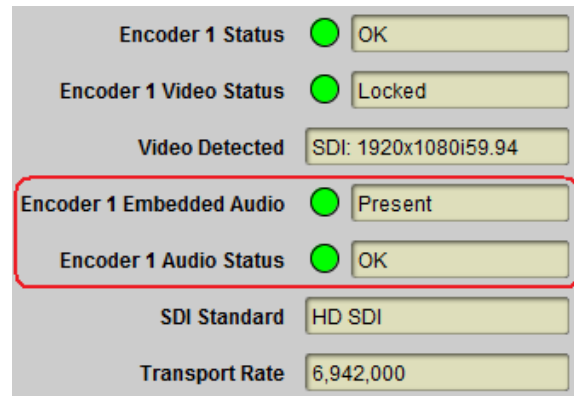

- **Encoder 1/2 Embedded Audio:** This indicator flags whether or not embedded audio is actually present on the selected Group/Channel combination (see Basic Tab – Audio Configuration). The following values are presented:
  - **Green Present:** Embedded audio is present in the selected Group/Combination.
  - **Yellow Not Present:** The SDI input has no lock, it is not possible to determine whether embedded audio is present or not.
  - **Red Not Present:** Embedded audio is not present in the selected Group/Channel combination. Check the source settings, or select a different Group/Channel combination.
- **Encoder 1/2 Audio Status:** This indicator flags any errors in the embedded audio and will have the following values:
  - **Green OK:** No errors detected.
  - **Yellow Not Present:** Embedded audio is not present – errors cannot be detected. This status will be issued when there is no SDI lock, or when there is no embedded audio.
  - **Red Error:** Embedded audio errors are being detected. If this indicator is red, audio is corrupted or glitching. The possible causes for this are:
    - Corrupted embedded audio in the input – checksum errors
    - Audio sampling rate mismatch
    - The channel is configured for Dolby Passthrough, and the data present in the selected Group/Channel is not Dolby AC-3

If Dolby Passthrough is configured, one additional indicator is shown:

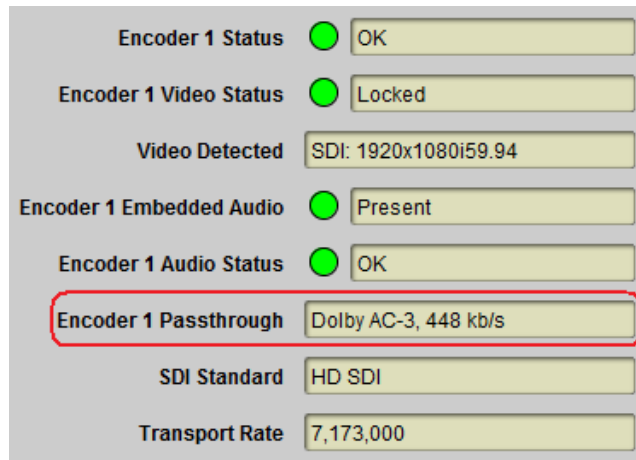

- **Encoder 1/2 Passthrough:** This indicator contains the status of the Dolby AC-3 Passthrough function. It may contain the following values:
  - **Dolby AC-3, xxx kb/s:** this means that the data in the selected group/pair has been correctly identified as Dolby AC-3; its bit rate is reported here.
  - **Unknown Format:** this means that data is present in the selected group/pair, but it is not Dolby AC-3.
  - **Not Present:** this means that there is no data in the selected group/pair.

If **Secondary Audio** is **Enabled**, then the status of both audio channels will show in the Encoder 1 Status tab. The actual indicators displayed will depend on the individual settings of each audio channel. The picture below shows an example where both audio channels are embedded Dolby AC-3 Passthrough.

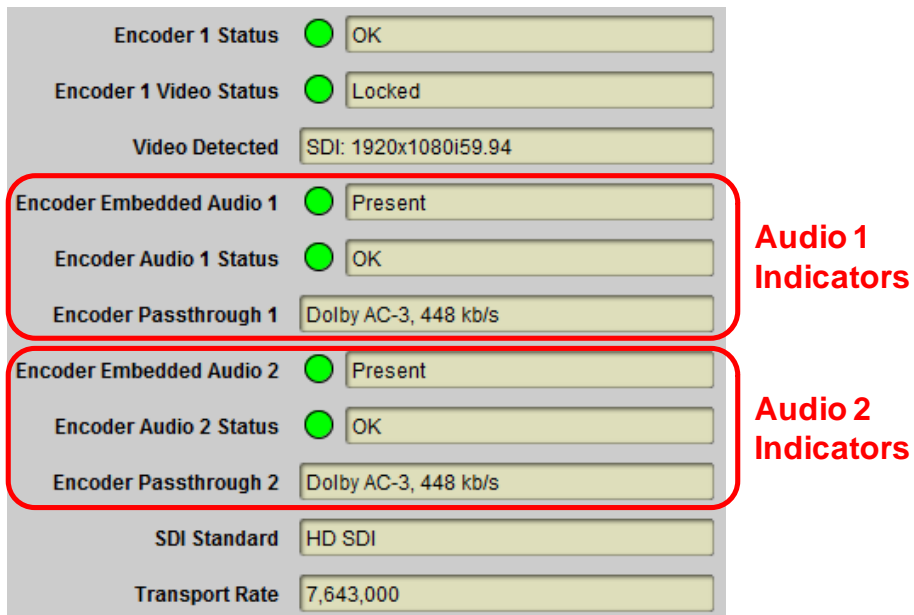

The picture below shows an example where four audio channels are enabled:

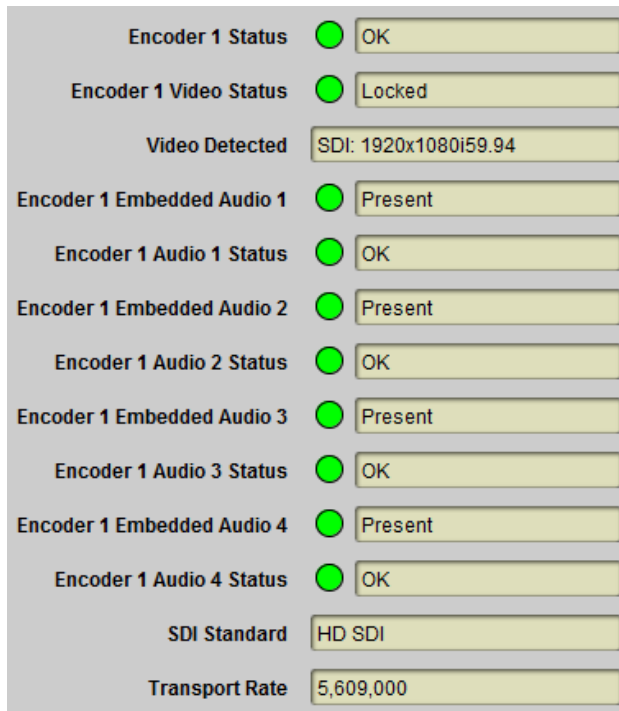

If SCTE 35 injection is enabled in the Advanced Tab – VBI/Ancillary Data Insertion, the following additional indicators are displayed:

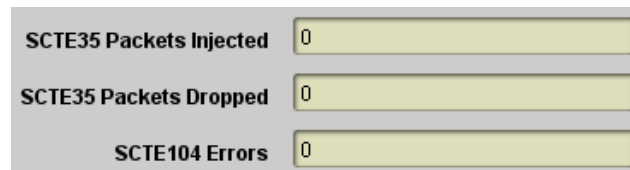

- **SCTE 35 Packets Injected:** shows a count of how many SCTE 35 packets have been successfully injected in the transport stream for this encoder. Successful SCTE 35 injections are also logged.
- **SCTE 35 Packets Dropped:** if there are too many SCTE 104 messages, it may not be possible to insert all the SCTE 35 packets due to internal limitations in the 9223-ENC. The 9223-ENC can insert up to 10 SCTE 35 packets per second, which is sufficient for all usual ad insertion applications. If this indicator is nonzero, contact support.
- **SCTE 104 Errors:** shows a count of SCTE 104 errors in the incoming signal. A nonzero count indicates that the device upstream of the 9223-ENC is non-compliant. Contact the vendor of that equipment.

If SMPTE-2038 injection is enabled in the Advanced Tab – VBI/Ancillary Data Insertion, the following additional indicators are displayed:



<b>SMPTE-2038 Injection Rate</b>	134,601
<b>SMPTE-2038 Packets Injected</b>	12333

- **SMPTE-2038 Injection Rate:** shows the current average injection rate for ANC packets carried using SMPTE-2038, over the last 2-second interval. This can be used to set the maximum injection rate.
- **SMPTE-2038 Packets Injected:** shows a running count of how many SMPTE-2038 transport packets have been injected since the encoder was last restarted.

If HTTP Live Streaming is selected in the Encoder Connections Tab, four more indicators are added to the status area:

<b>Encoder 1 Status</b>	OK
<b>Encoder 1 Video Status</b>	Locked
<b>Video Detected</b>	Composite: NTSC
<b>Closed Captions</b>	Present
<b>Transport Rate</b>	2,586,000
<b>IP Output Rate</b>	2,312,977
<b>Segments Transferred</b>	17
<b>HTTP Dropped Segments</b>	0
<b>HTTP Transfer Errors</b>	0

- **IP Output Rate:** this indicator reports the average transfer rate into the server, in bits/second, averaged over the last segment.
- **Segments Transferred:** this indicator reports the number of bitstream segments successfully transferred so far.
- **HTTP Dropped Segments:** this indicator reports the number of segments dropped. A segment will be dropped if the previous segment has not been completely transferred when it becomes ready. A non-zero count here indicates that there is a performance problem between the encoder and the server – either in the network (not enough bandwidth) or in the server (not enough CPU power/disk bandwidth). If the segment size is small (3 seconds or less), increasing the segment size may improve the situation.
- **HTTP Transfer Errors:** this indicator reports the number of errors encountered while transferring segments. These may be network errors, or may be configuration errors. The exact error description will be shown in the configuration area, in the area on top of the **Apply** button. One example is shown below, where the server is not responding (incorrect IP address).

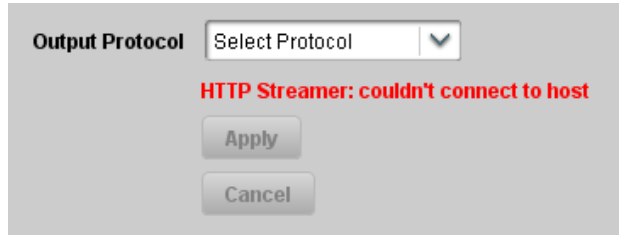

If Direct HTTP Streaming is selected in the Encoder Connections Tab, three indicators are added to the status area:

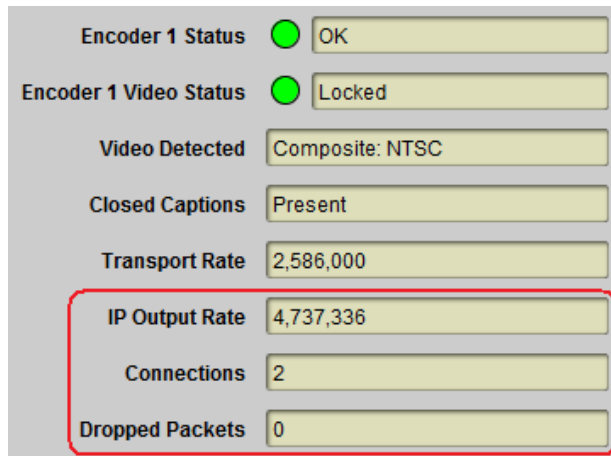

- **IP Output Rate:** This indicator reports the aggregate average bit rate to all connected clients (so it can be higher than the transport rate).
- **Connections:** This indicator reports the number of clients currently connected to this encoder.
- **Dropped Packets:** This indicator reports the number of transport packets dropped over the current connections. Once a connection terminates, the dropped packet count for that connection is reset.

If RTMP is selected in the Encoder Connections Tab, five indicators are added to the status area:

Encoder 1 Status	<span style="color: green;">●</span> OK
Encoder 1 Video Status	<span style="color: green;">●</span> Locked
Video Detected	SDI: 1280x720p60
SDI Standard	HD SDI
Transport Rate	6,980,000
IP Output Rate	6,173,960
Encoder 1 RTMP Status	<span style="color: green;">●</span> Connected
Server Connection	Backup
Video Buffer %	2
Audio Buffer %	0
Dropped Packets	0

- **IP Output Rate:** this field reports the average bit rate transferred to the server. It will be lower than the transport rate due to the lower container overhead used by RTMP. It is possible for the IP Output Rate to be less than the intrinsic bit rate of the encoder for short periods of time, depending on server and network conditions. The encoder will buffer the bitstream and attempt to “catch up” in these cases. If it cannot, audio/video bitstream data may be dropped.
- **Encoder RTMP Status:** This indicator reports the state of the RTMP connection to the server. The possible states are:
  - ● **Connected:** The encoder has established a connection with the RTMP server and is transferring data.
  - ● **Waiting for Encoder:** The encoder is not attempting to connect to the RTMP server. The reasons are:
    - The encoding core is not running (i.e., the encoder is not generating bitstream). This can be because the encoder is explicitly stopped (**Encoder State** set to **Stopped** in Basic Tab – General Configuration) or it has no valid input.
    - The RTMP output is configured not to connect to the server (**Connect** set to **No** in the RTMP configuration section).
  - ● **Not Connected:** The encoder is running, but it is unable to connect to the RTMP server. Possible reasons are:
    - The encoder cannot contact the server.
    - The RTMP parameters are incorrect.
    - The server was specified as a host name, and the encoder cannot convert that to an IP address (i.e., no DNS, or server name misspelled).

Check the Admin Event Log Tab for more details.
- **Server Connection:** RTMP can be optionally configured with a primary and a backup server. If the primary server cannot be contacted, the encoder will attempt to connect to

---

the backup server. This field indicates which server (**Primary** or **Backup**) the encoder is currently connected or attempting to connect.

- **Video Buffer %, Audio Buffer %:** The encoder has separate buffers for audio and video. These buffers are used to temporarily store the bitstream if there is not enough network and/or server bandwidth. However, if this situation persists, the buffers start to fill up. These indicators report the current state of the buffers. If they overflow, data is dropped. Ideally, these buffers should stay empty (close to 0%).
- **Dropped Packets:** If the buffers overflow, data is dropped. The encoder will drop entire access units (an audio block or a video frame). This indicator has a count of the number of access units dropped for the current connection. This count resets when a new connection is established.

If RIST is selected in the Encoder Connections Tab, the following items are added to the status area:

Output Rate (b/s)	4,986,512
Bitmask Requests	409
Range Requests	0
Retransmitted Packets	99
Packets Not Found	10381
Invalid NACK Requests	0
Requested Stream Not Found	1
Dropped Retransmissions	0
RTCP Received	2813
RTT Echo Received	41

- **IP Output Rate:** this field contains the measured total IP output payload bit rate, in bits/sec. It can be lower than the transport rate, if NULL packets are removed from the stream, or higher, if multiple destinations are enabled.
- **Bitmask Requests:** this field contains the number of bitmask retransmission requests received by the encoder.
- **Range Requests:** this field contains the number of range retransmission requests received by the encoder.
- **Retransmitted Packets:** this field contains the number of packets that have been retransmitted. It is possible that this number is higher than the number of retransmission requests because one request can ask for up to 17 packets.
- **Packets Not Found:** this field contains the number of packets whose retransmission has been requested, but are no longer in the encoder buffer. If this number grows, increase the NACK Window in the **Error! Reference source not found.** configuration section.
- **Invalid NACK Requests:** this field contains the number of NACK requests deemed invalid or malformed. If this number is non-zero, please contact the receiver vendor.

- 
- **Requested Stream Not Found:** each of the encoder output streams has its individual SSRC identifier. A non-zero count here indicates that the encoder received a request for an SSRC it does not have. The possible causes for this are:
    - The encoder has been rebooted, and received a request matching an old SSRC.
    - A network routing or forwarding problem caused the encoder to receive a request that was intended for a different encoder.
  - **Dropped Retransmissions:** this field contains the number of packet retransmissions that were dropped due to the retransmission rate limit configured in the RIST section.
  - **RTCP Received:** this field contains the number of RTCP packets received from the remote endpoints.
  - **RTT Echo Received:** this field contains the number of RTCP RTT Echo requests received.

---

## ASI Outputs Tab

The 9223-ENC has 2 ASI output ports that can be independently configured. This tab is used to configure and manage them.

### **ASI Ports: Configuration Tab**

The default appearance of the Configuration tab is:

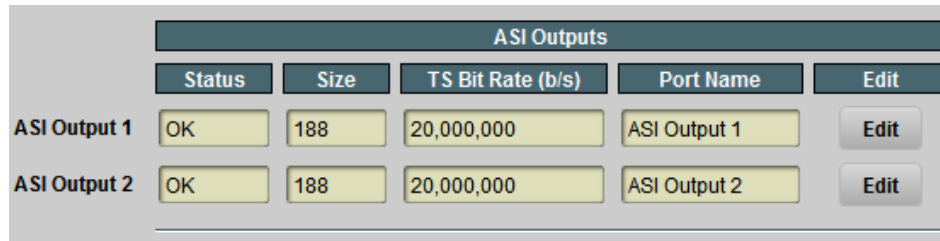

ASI Outputs					
	Status	Size	TS Bit Rate (b/s)	Port Name	Edit
ASI Output 1	OK	188	20,000,000	ASI Output 1	Edit
ASI Output 2	OK	188	20,000,000	ASI Output 2	Edit

The **ASI Outputs** table contains the current configuration of the ports, as follows:

- **Status:** Indicates the port status. It can contain the following values:
  - **OK:** Port is operating normally.
  - **Unlocked:** Port is unlocked. This means that the port is in Automatic Bit Rate mode and it has no input.
  - **Overflow:** Transmit overflow. This means that the ASI Output is in Manual mode, and the configured bit rate is insufficient to carry the bitstreams connected to it. This situation will raise an alarm as packets are being dropped.
- **Size:** Indicates the configured transport packet size, in bytes.
- **TS Bit Rate (b/s):** This reports the actual transport stream bit rate, in bits/second.
- **Port Name:** This reports the user-configured Port Name.
- **Edit Button:** Clicking on this button allows configuration of the port. The ASI Output Configuration screen appears, with the settings for the selected port.

To configure an individual port, click on the **Edit** button for that port. The following configuration interface opens:

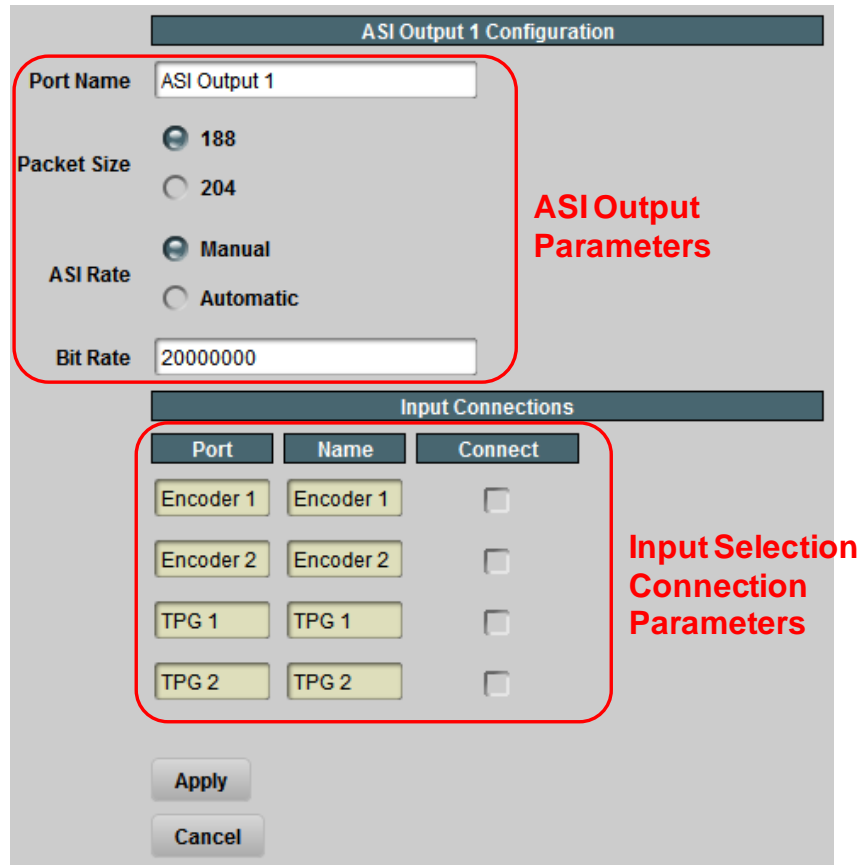

The configuration screen can be divided into two parts:

- ASI Output Parameters
- Input Selection Connection Parameters

The Connection Parameters are common to all outputs, and are described in the Connections section, later in this document. The ASI Output Parameters are:

- **Port Name:** All 9223-ENC encoders and outputs can be assigned a user-defined **Port Name**. This name is used to identify the port later when making connections. Use any descriptive name suitable for your application, or accept the default.
- **Packet Size:** Select between 188 and 204 bytes.
- **ASI Rate:** The following two modes are available:
  - **Manual:** In this mode, the ASI output bit rate is set to the value entered in the **Bit Rate** field. The ASI output will maintain this rate at all times, as follows:
    - If there is no connection to the ASI port, or if the input connected to the ASI port is not active, the ASI port will transmit NULL packets.
    - If the connected input bit rate is lower than the rate entered in the **Bit Rate** field, the ASI port will add NULL packets as required to pad it to the desired value. PCR packets will be re-stamped as required.

- If the connected input bit rate is higher than the rate entered in the **Bit Rate** field, the ASI port will attempt to remove NULL packets from the connected bitstream in order to achieve the desired value. PCR packets will be re-stamped as required. If there are not enough NULL packets to be deleted, packets will be dropped, and an alarm will be raised. This alarm will be indicated in the Dashboard™ **Card State** field, in the front Status LED, and in the ASI Statistics page.
  - **Automatic:** If this mode is selected, the **Bit Rate** field disappears. The ASI output will exactly match the rate of the connected bitstreams. However, if the connected ports have no data, or if there is no connection to the ASI port, there will be no output, and any connected downstream ASI device will indicate loss of sync. The ASI Statistics page will indicate this state, as well as the rear I/O panel indicator LED. Note that an alarm will only be raised if there is at least one connection to the ASI output.
- **Bit Rate:** This field is only available if the **ASI Rate** mode is set to **Manual**. Enter the desired ASI output bit rate here, in bits/second. The minimum value is 64,000 and the maximum value is 213,000,000.

Once the port is configured, click on the **Apply** button, and the configuration takes effect.

### **ASI Ports: Statistics Tab**

The Statistics Tab for the ASI Ports provides a quick visual summary status for the ports. A sample, corresponding to the table example of the previous section, is depicted below.

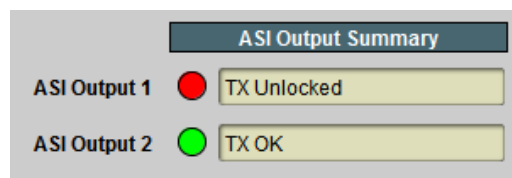

Each of the ASI Port indicators can have the following values:

- ● **TX OK:** The port is operating normally in transmit mode (ASI Output).
- ● **TX Overflow:** The connected bit rate is excessive. The Dashboard™ Card State will be red and the Status LED in the front of the board will also be red. To correct this problem, either reduce the connected bit rate, or increase the ASI output bit rate, or configure the port in Automatic mode. **If this alarm is active, data is being dropped.**
- ● **TX Unlocked:** The port is in automatic bit rate, and there is no data rate coming to it. Any downstream ASI receivers will lose lock. Dashboard™ Card State and the Status LED will be red if there is a connection to this port.



---

## IP Outputs Tab

IP Outputs receive data from connected inputs, format this data for transmission over UDP/IP, and send it with very precise timing over the Ethernet ports. The 9223-ENC supports up to 4 transport stream outputs per Ethernet port. IP Outputs have the following specifications:

- Formats supported:
  - MPEG-2 Transport Packets over UDP/IP
  - MPEG-2 Transport Packets over RTP/UDP/IP
- Number of MPEG-2 Transport Packets per UDP datagram: fixed at 7.
- Addressing support: unicast, multicast and broadcast.
- Advanced control over the IP header fields available.
- SMPTE 2022 FEC available<sup>4</sup>. The 9223-ENC supports one FEC session per Ethernet port.

### *IP Outputs: Configuration Tab*

IP output stream can be created, configured, and removed using this configuration area. Before any streams are created, the Configuration Tab appears as depicted below:

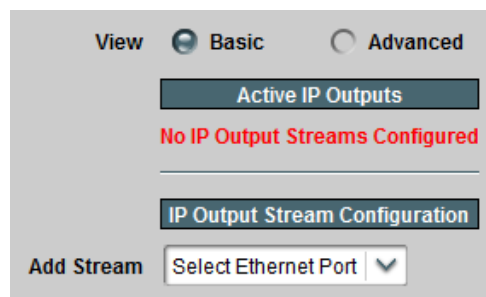

To create an IP Output stream, first select the desired Ethernet port in the **Add Stream** drop-down box. Once that selection is made, the IP Output Stream Configuration is displayed, as depicted below (Basic View). The configuration screen has two areas:

- **IP Output Parameters:** these are the parameters specific to the IP Output configuration. The set of parameters available for configuration depends on the **View** selection. In the **Basic** view, suitable default values are entered for the advanced parameters.
- **Input Selection Connection Parameters:** these allow a connection to be made to the output stream.

The Connection Parameters are common to all outputs, and will be described in the Connections section, later in this document.

---

<sup>4</sup> Previously known as Pro-MPEG FEC COP3.

**IP Output Stream Configuration**

Add Stream: Ethernet Port 1

Enabled:  Yes  No

UDP Port: 1024

Destination Address: 225.1.1.1

Stream Name: Port 1 Stream 1

NULL Padding:  Disabled  Enabled - Automatic Rate  Enabled - Manual Rate

**IP Output Parameters**

**Input Connections**

Port	Name	Connect
Encoder 1	Encoder 1	<input type="checkbox"/>
Encoder 2	Encoder 2	<input type="checkbox"/>
TPG 1	TPG 1	<input type="checkbox"/>
TPG 2	TPG 2	<input type="checkbox"/>

**Input Selection Connection Parameters**

The Basic View configuration parameters are as follows:

- **Enabled:** This allows the output stream to be enabled or disabled. If it is disabled, no packet transmission takes place. This feature is provided for testing purposes (i.e., temporarily disable an output for fault-finding). Most users will leave the stream enabled.
- **UDP Port:** selects the UDP port to transmit to. Valid values are between 1 and 65535. Note that, in traditional IP networks, UDP ports between 1 and 1023 are reserved for administrative uses. The use of UDP ports 1024 and higher is recommended. The 9223-ENC, however, will accept any legal value. Note that if the port is configured for RTP (see the Advanced View discussion later in this section), the UDP port must be an even number, and the 9223-ENC user interface will enforce this restriction – odd numbers will be automatically rounded up.
- **Destination Address:** selects the IP address to transmit to. Any unicast or multicast address can be entered here, with the exception of the loopback range (127.0.0.0 to 127.255.255.255). The 9223-ENC will also accept the broadcast IP address of 255.255.255.255, and will transmit the packets as Ethernet broadcasts. Use of broadcasts, however, is strongly discouraged.
- **Stream Name:** All 9223-ENC input and output ports can be assigned a user-defined name. This name is used to identify the stream later when making connections. Use any descriptive name suitable for your application, or accept the default.

- 
- **RTP:** If this box is checked, the 9223-ENC will include RTP (Real Time Protocol) headers in the output flow. If it is not checked, the transport stream will be sent over UDP/IP without any additional headers. Note that RTP requires the use of even UDP port numbers; when this box is checked, the user interface will enforce this restriction. The 9223-ENC will not generate RTCP packets.
  - **SMPTE 2022 FEC:** The 9223-ENC supports SMPTE 2022 FEC in one stream per Ethernet interface. If no streams are currently configured for SMPTE 2022 FEC, this box will be displayed. If it is not displayed, then another stream is already using the feature. Check this box to enable transmission of SMPTE 2022 FEC packets for this stream. Note that SMPTE 2022 requires the use of RTP; checking this box will cause the RTP box to be checked as well. See SMPTE 2022 FEC Support section later in this document for a detailed description of the FEC configuration.
  - **NULL Padding:** This setting controls whether or not NULL packets are transmitted, making the stream completely CBR. IP networks are inherently VBR, and do not require NULL packets (which carry no information). However, the decoders may need them. The following is a good set of rules for deciding whether or not to send NULL packets:
    - If all your decoders are consumer IP set-top boxes or PCs running software decoders, NULL packets can be disabled.
    - If your decoders include professional IRDs, NULL packets must be enabled. The great majority of professional IRDs will not work without them.
    - If you are generating an MPTS (routing both encoders to the stream), enable NULL packets. An MPTS without NULL packets is technically illegal as per ISO/IEC 13818-1, but some systems support it.
    - If you are not sure about what kind of decoder will be receiving the stream, enable NULL packets.

This control offers the following options:

- **Disabled:** NULL packets are disabled and will not be transmitted. This will cause the stream to be somewhat VBR, even if the encoder is set to CBR mode.
- **Enabled – Automatic Rate:** This setting enables NULL packets, but the bit rate is automatically set by the 9223-ENC to the minimum suitable value. This is the recommended setting. If you later reconfigure an encoder connected to this stream, the rate will be automatically adjusted.
- **Enabled – Manual Rate:** This setting allows you to specify the overall stream bit rate. If you specify the bit rate, it must be high enough to support the connected encoders (i.e., it must be at least equal to the sum of the encoder **Transport Rate**, found in each encoder **Status** tab). Specifying a rate that is not high enough will cause the IP Output to drop packets. Note that if this option is selected, the IP Output will be transmitting continuously at the selected bit rate, regardless of connections or the state of the encoders. If there is no connection to the IP Output, it will transmit only NULL packets; if there are connections and the encoders are stopped, it will transmit NULL packets plus (P)SI tables.

If the Advanced View is selected, four more parameters are available for configuration:

View  Basic  **Advanced**

---

**IP Output Stream Configuration**

Add Stream

Enabled  Yes  No

UDP Port

Destination Address

Stream Name

TOS

TTL

DF Bit  Set  Not Set

RTP

Advanced Parameters

- **TOS:** This parameter allows the configuration of the Type-Of-Service (TOS) byte in the IP header (also known as the Differentiated Services – DS – field). Valid values are between 0 and 255. Configuring this is only useful if the downstream router is configured to honor the field.
- **TTL:** This parameter allows the configuration of the Time-To-Live (TTL) byte in the IP header. Valid values are between 0 and 255. If not explicitly configured, it defaults to 128. This field controls how many hops the packet can traverse before it is dropped by a router. The default value of 128 is suitable for virtually all applications.
- **DF Bit:** This parameter allows the configuration of the Do-not-Fragment (DF) bit in the IP header. The 9223-ENC will never produce fragmented packets, and with the UDP payload set to 7 transport packets, the IP packets are guaranteed to fit inside the Ethernet MTU. This control is provided for compatibility with legacy switches/routers. Some legacy equipment may exhibit performance problems if this bit is not set. This is not an issue with current network equipment.

### **SMPTE 2022 FEC Support**

The 9223-ENC supports one FEC session per Ethernet port. A checkbox for **SMPTE 2022 FEC** will be displayed if the feature is available. Once this feature is enabled for one of the streams in a given Ethernet port, the checkbox will no longer be displayed.

Once the **SMPTE 2022 FEC** box is checked, additional parameters become available for configuration:

RTP   
 SMPTE 2022 FEC   
 FEC Mode  Column Only  
                    Row and Column  
 Columns   
 Rows   
 FEC Overhead 25%

- **FEC Mode:** If you select **Column Only**, the 9223-ENC will send a single FEC flow, corresponding to the column protection data, using a UDP port number corresponding to the media UDP port number plus 2. If you select **Row and Column**, the 9223-ENC will send two FEC flows, the first corresponding to the column protection data, and the second corresponding to the row protection data. The row protection data will be sent using a UDP port number corresponding to the media UDP port number plus 4. Note that not all receivers support Row and Column mode; such receivers will only use the FEC Column data and discard the FEC Row data.
- **Columns:** Number of columns in the FEC matrix. This variable must be between 1 and 20 if **FEC Mode** is set to **Column Only**, and between 4 and 20 if it is set to **Row and Column**.
- **Rows:** Number of rows in the FEC matrix. This variable must be between 4 and 20.
- **FEC Overhead:** This field is updated as configuration is entered, and contains the overhead for the selected FEC configuration. Note that not all parameter changes cause the overhead to change. The FEC overhead is the sum of a Column overhead and a Row overhead (which is zero if **FEC Mode** is **Column Only**). The overhead is a function of the settings, as follows:
  - **Increasing** the number of columns **decreases** the Row overhead (if enabled) and **does not change** the Column overhead.
  - **Increasing** the number of rows **does not change** the Row overhead and **decreases** the Column overhead.
  - **Decreasing** the number of rows and columns has the opposite effect as the previous items.

The following constraints apply to the FEC function:

- The number of rows must be between 4 and 20.
- The number of columns must be between 1 and 20 for Column Only mode, or between 4 and 20 in Row and Column mode.
- The size of the FEC matrix (product of the number of rows and the number of columns) must not exceed 100.

The user interface will not allow invalid configurations to be entered, and will automatically make parameter adjustments as required. Examples:

- 
- If you select Row and Column, and the number of columns is less than 4, it will be automatically adjusted to 4.
  - If your number of rows is 10, and you set the number of columns to 20, the number of rows will be automatically reduced to 5.

The number of rows and columns should be selected based on some understanding of the packet loss characteristics of the network between the 9223-ENC and the receivers. If you have no statistics on packet loss, the recommended setting is 20 columns and 5 rows to maximize the correction capabilities. Most receivers that support SMPTE 2022 FEC provide packet loss/recovery statistics. After running for a while, if the network is found to be clean, consider reducing the matrix to 10 rows and 10 columns, which will reduce the overhead.

## Completing the Configuration

Once the configuration information is filled in, click on the **Apply** button to make it active. If there are no errors, the stream will be created, and the configuration area disappears. If any errors are detected, they will be displayed at the top of the **Apply** button.

The following configuration-related errors are flagged:

- **Error: UDP Port/Address conflict with Port X/Y:** you have configured two IP Output streams with the same destination IP Address and UDP port, on the same Ethernet interface. Please review your settings. Note that ports with FEC enabled will use either two or three UDP ports (depending on the FEC settings) – these are checked as well.
- **Maximum number of streams exceeded on this port:** you will receive this message if you attempt to create more than 4 IP outputs on a given Ethernet port.
- **Error: No SMPTE 2022 FEC License Available:** the SMPTE 2022 function requires licensing. Please contact support to obtain a license.

If the configuration is successful, the output stream will be added to the Active IP Outputs table.

## Active IP Outputs Table

Once the output is created, it is added to the **Active IP Outputs** table, which has **Basic** and **Advanced** views. This table provides a summary of the configuration and status of the output stream. An example of this table, in the Basic view, is depicted below

View  Basic  Advanced

Active IP Outputs									
Enabled	TS	UDP	Destination	RTP	FEC	Stream	Edit	Delete	
	Bit Rate(b/s)	Port	Address			Name	Stream	Stream	
Stream 1/1	Yes	2,463,000	1024	225.1.1.1	No	Off	SPTS From Encoder 1	Edit	Delete
Stream 1/2	Yes	2,586,000	1026	225.1.1.2	Yes	20X5 C	Encoder 1 NULL-padded	Edit	Delete
Stream 2/1	Yes	5,324,000	1024	225.1.2.1	Yes	Off	MPTS Auto Rate	Edit	Delete
Stream 2/2	Yes	6,000,000	1026	225.1.2.2	Yes	10X10 R-C	MPTS Manual Rate	Edit	Delete

The Basic view includes the following:

- **Enabled:** The configured value of this parameter.
- **TS Bit Rate (b/s):** This column provides the current bit rate of the output transport stream. This does not include UDP and IP overhead, nor RTP/FEC overhead.
- **UDP Port:** The configured value of this parameter.
- **Destination Address:** The configured value of this parameter.
- **RTP:** The configured value of this parameter
- **FEC:** Summary of the FEC configuration. If FEC is disabled, this field will indicate it as **Off**. If FEC is enabled, this field will indicate the FEC matrix size as Columns  $\times$  Rows, and the protection mode as **C** for Column Only or **R-C** for Row and Column. In the example above, Stream 1/1 has Column Only FEC with 1 Column and 4 Rows, and Stream 2/1 has Row and Column FEC with 4 Columns and 10 Rows.
- **Stream Name:** The configured stream name.
- **Edit Stream:** If you click on this button, you can modify all the parameters for this output. The configuration area will re-open with the current output settings.
- **Delete Stream:** If you click on this button, the stream is deleted and removed from the table.

When the Advanced view is selected, additional fields appear in the table, as depicted below:

View  Basic  Advanced

Active IP Outputs														
Enabled	Line	Null	UDP	Destination	TOS	TTL	DF	RTP	FEC	Destination	Stream	Edit	Delete	
	Bit Rate(b/s)	Padding	Port	Address						MAC	Name	Stream	Stream	
Stream 1/1	Yes	2,564,065	No	1024	225.1.1.1	0	128	Set	No	Off	01005e010101	SPTS From Encoder 1	Edit	Delete
Stream 1/2	Yes	3,265,119	Auto	1026	225.1.1.2	0	128	Set	Yes	20X5 C	01005e010102	Encoder 1 NULL-padded	Edit	Delete
Stream 2/1	Yes	5,591,009	Auto	1024	225.1.2.1	0	128	Set	Yes	Off	01005e010201	MPTS Auto Rate	Edit	Delete
Stream 2/2	Yes	7,575,683	Manual	1026	225.1.2.2	0	128	Set	Yes	10X10 R-C	01005e010202	MPTS Manual Rate	Edit	Delete

The Advanced view includes all items in the Basic view plus the following:

- 
- **Line Rate:** This column replaces the **TS Rate** column in the Advanced view. It indicates the actual Ethernet line rate for the stream, including the MAC, IP, UDP, RTP and FEC overheads.
  - **Null Padding:** The configured value of this parameter (shown as **No**, **Auto**, or **Manual**).
  - **TOS:** The configured value of this parameter.
  - **TTL:** The configured value of this parameter.
  - **DF:** The configured value of this parameter.
  - **Destination MAC:** The destination MAC address for this IP Output. For multicast destination addresses, this is derived from the destination IP address using the rules from RFC 1112. For unicast destination addresses, this is obtained using the ARP protocol. If this entry is the word **Unknown**, the 9223-ENC has failed to obtain a destination MAC address. The IP Output is **not** streaming. A more detailed description of the unicast MAC address algorithms used in the 9223-ENC is presented below.

## Managing Unicast MAC Addresses

When the 9223-ENC is configured with a unicast destination address, it needs to obtain a corresponding MAC address (corresponding to either the final destination, if it is in the same subnet, or to the default gateway). These MAC addresses are obtained using the ARP protocol. The 9223-ENC uses a custom MAC address management algorithm, designed specifically for MPEG operation.

When an IP Output stream with a unicast destination address is created, the 9223-ENC immediately starts attempting to obtain a MAC address for it, using standard ARP requests. These requests are issued every two seconds until answered. No packets will be transmitted on that IP Output until a MAC address can be obtained. Note that this process will happen even if the stream is configured to be in the disabled state.

Once a MAC address is obtained, the 9223-ENC will cache it for about 5 minutes, as it is usual for IP devices. Unlike other IP devices, the 9223-ENC will keep on using the MAC address until a response is received, to avoid stream interruptions. If no response is received at that time, the 9223-ENC will raise a yellow alarm. This alarm can be seen in the IP Output Statistics tab, described in detail below.

The current state of the 9223-ENC current streaming ARP cache is available in the Advanced View of the Active IP Outputs table, described above.

## ***IP Outputs: Statistics Tab***

The Statistics tab for the IP output ports contains a summary of each stream status. There are two sub-tabs: one for Ethernet 1, and another for Ethernet 2. The tab is depicted below:



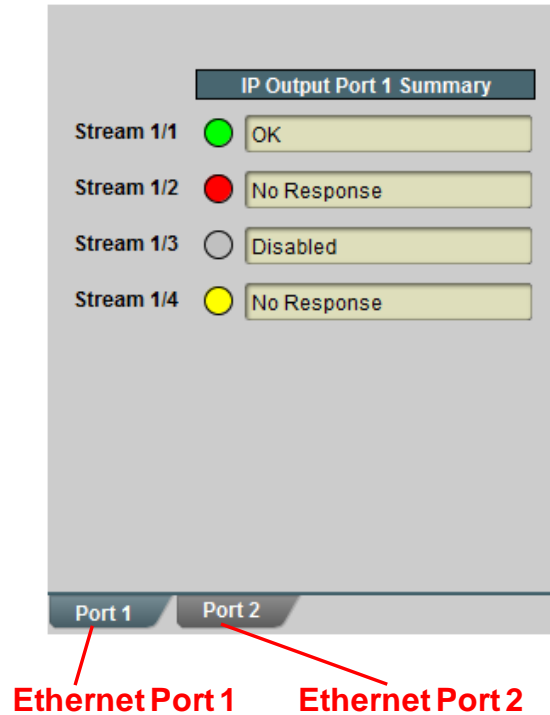

The indicators can have the following values:

- **OK:** The IP Output is operating normally (either streaming or ready to stream).
- **No Response:** The IP Output is configured for unicast operation, but it does not have a destination MAC address. If there is a connection to this output, Dashboard™ Card State and the Status LED will be red.
- **Overflow:** The IP Output is configured for NULL Padding with a manual rate, and the connected bitstream(s) exceed that configured manual rate. If this alarm is asserted, *packets are being dropped*. The Dashboard™ Card State and the Status LED will be red.
- **No Response:** The IP Output is configured for unicast operation, and the destination stopped responding to ARP. The IP Output is using an old cached MAC address. If there is a connection to this output, the Dashboard™ Card State will be yellow (but packets are being transmitted).
- **Disabled:** The IP Output has been disabled (by setting **Enable** to **No**).

---

## Connections Tab

The Connections allows the creation, deletion, and management of input-output connections. The Statistics tab includes all connected input/output status indicators and an overall summary status indicator, which allows the operator to immediately pinpoint errors.

### **Connections Configuration Tab**

The Connections configuration tab is depicted below. The message “No Connections” will be displayed if there are no configured input/output connections in the 9223-ENC. If the 9223-ENC has two encoder channels installed, there will be two lower tabs, to switch between the Connections configuration interface and the MPTS configuration/status interface.

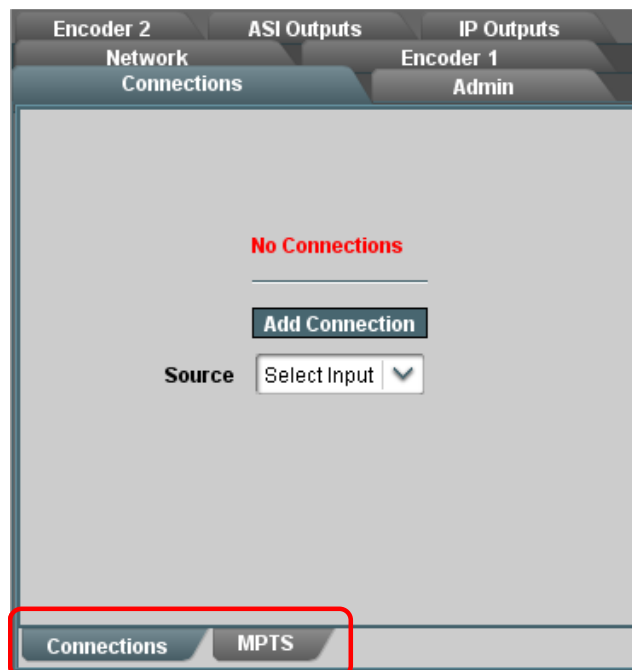

**Present only if two encoder channels are installed**

To establish a connection, simply select a source and a destination, and then click on Apply.

### **Source Selection**

There are four sources in the 9223-ENC:

- Up to two Encoder channels (described in the

Encoder 1, Encoder 2 Tabs section)

- Two Test Packet Generators (describe in the Admin Test Packet Generator Tab section)

The connection process starts by selecting one of these data sources, using the **Source** drop-down menu:

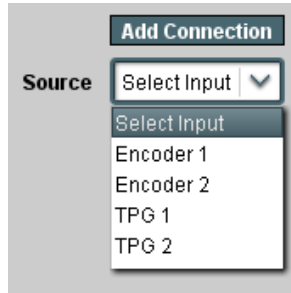

Once a source is selected, a list of available destinations is presented.

### Destination Selection

The list of available destinations always includes all the defined IP Output ports, as well as the two ASI ports. This interface is also available if you select ASI/IP Streaming in the Encoder Connections Tab, and in the Admin Test Packet Generator Tab. If **Stream Display** is set to **Stream Names**, the user-defined names are presented. This is displayed below.

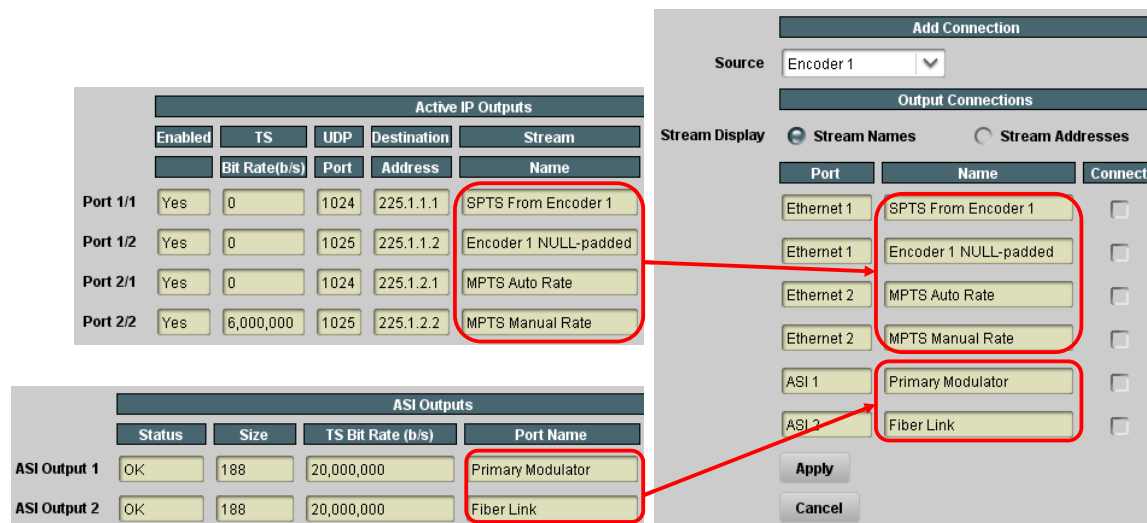

If you would prefer to make the output selection by Destination Address and UDP Port, set **Stream Display** to **Stream Addresses**; this option is illustrated below.

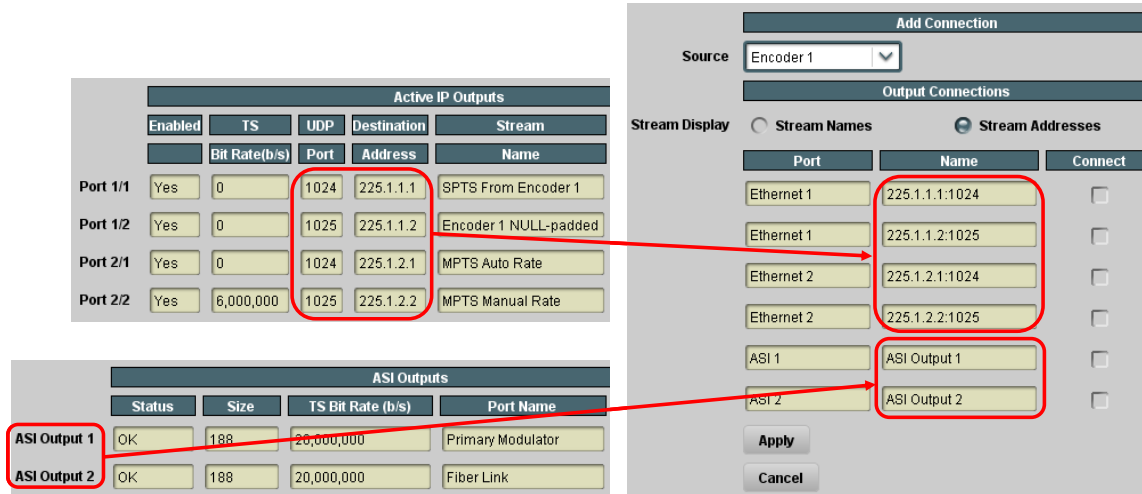

To make the connections, simply check the **Connect** box in front of the input you wish to use. You can connect any source to as many outputs as you wish. Conversely, unchecking the box disconnects that particular source-destination pair.

## Source Selection in the Output Ports

When configuring an output (ASI or IP), connections can be immediately made as well, in that output's configuration interface (see ASI Ports: Configuration Tab and IP Outputs: Configuration Tab). The selection parameters are depicted below. The user-defined names for the Encoders (and Test Packet Generators) are displayed in the user interface to facilitate identification. To make the connection, just click on the corresponding checkbox under **Connect**. Note that if an encoder channel is not available (either because it is not installed, or because it has been configured for HTTP Live Streaming), it will not show in the list.

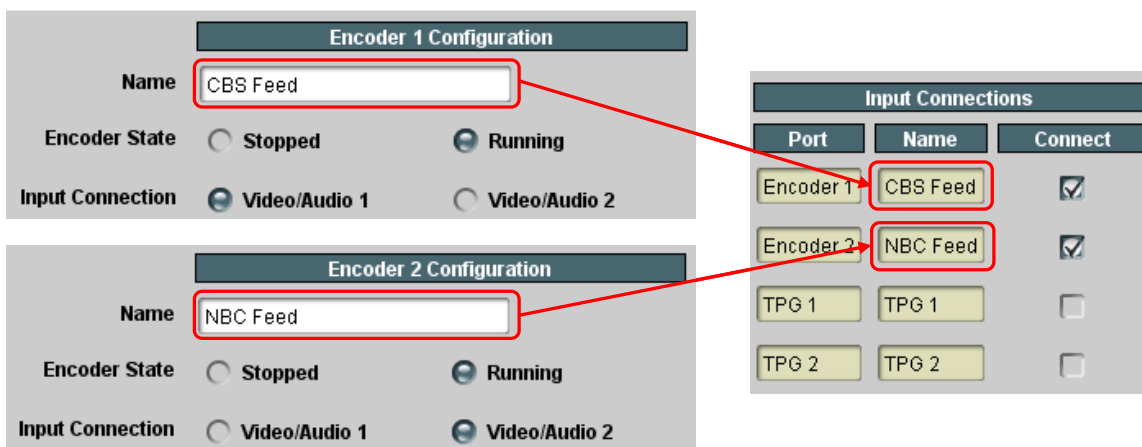

## The Established Connections Table

As connections are established (either in the Connections tab, or as part of the source or output configuration), they are added to the Current Connections table. Regardless of how they got

added, the connections can be managed using the functions in this table. A sample is depicted below.

The following columns are available in this table:

- **Source Port:** this column indicates the physical port of the connection. The possible values are **Encoder 1**, **Encoder 2**, **TPG 1** and **TPG 2**.
- **Source Name:** this column contains the user-defined name for the source.
- **Output Port:** this column indicates the physical output port for the connection. The possible values are **Ethernet 1**, **Ethernet 2**, **ASI 1** and **ASI 2**.
- **Output Name:** If the **Stream Display** control at the top of the table is set to **Stream Names**, this column will have the user-defined name for the output. If it is set to **Stream Addresses**, it will have the destination IP address and UDP port for IP Outputs, and the values **ASI Output 1** and **ASI Output 2** for the ASI ports.
- **Delete:** if you click on this button, the corresponding connection will be deleted.

Established Connections				
Stream Display <input checked="" type="radio"/> Stream Names <input type="radio"/> Stream Addresses				
Source Port	Source Name	Output Port	Output Name	Connection
Encoder 1	CBS Feed	Ethernet 1	SPTS From Encoder 1	Delete
Encoder 1	CBS Feed	Ethernet 1	Encoder 1 NULL-padded	Delete
Encoder 1	CBS Feed	Ethernet 2	MPTS Auto Rate	Delete
Encoder 2	NBC Feed	Ethernet 2	MPTS Auto Rate	Delete
Encoder 1	CBS Feed	Ethernet 2	MPTS Manual Rate	Delete
Encoder 2	NBC Feed	Ethernet 2	MPTS Manual Rate	Delete
Encoder 1	CBS Feed	ASI 1	Primary Modulator	Delete
Encoder 2	NBC Feed	ASI 1	Primary Modulator	Delete
Encoder 1	CBS Feed	ASI 2	Fiber Link	Delete
Encoder 2	NBC Feed	ASI 2	Fiber Link	Delete

### Connection Statistics Tab

The Connection Statistics Tab presents the combined status of all the established connections, in one table. It includes the Source Port, Source Name, Output Port and Output Name fields to identify the connections, and the rows are in the same order as the table in the Configuration Tab. The Statistics tab contains two additional fields, the **Source Status** and the **Output Status**. Since these are color-coded, it is simple to quickly identify any problems. If any of the **Source Status** or **Output Status** indicators are red, the DashBoard™ Card State will be red as well, and the front panel **STAT** LED will also be red.

The meaning of the indicators is as follows:

- **OK:** The stream is operating normally. If it is an encoder, it means that it is operating normally; if it is an output, it means that it is either transmitting or ready to transmit.
- **Warn:** The stream is configured but disabled. Simply enabling the stream may clear this situation.
- **Error:** The stream is configured but has detected a problem. If it is an encoder, it is not running. If this is an output, it normally means that the output is either unable to send (e.g., an IP output configured for unicast but unable to find the destination MAC address) or dropping packets (e.g., an oversubscribed ASI or IP output in manual rate mode). ASI Outputs with Automatic Rate will be in this state if they do not have data to transmit.

A sample of the Connection Statistics Tab is depicted below.

Established Connections					
Source Port	Source Name	Source Status	Output Port	Output Name	Output Status
Encoder 1	CBS Feed	● OK	Ethernet 1	SPTS From Encoder 1	● Warn
Encoder 1	CBS Feed	● OK	Ethernet 1	Encoder 1 NULL-padded	● OK
Encoder 1	CBS Feed	● OK	Ethernet 2	MPTS Auto Rate	● OK
Encoder 2	NBC Feed	● OK	Ethernet 2	MPTS Auto Rate	● OK
Encoder 1	CBS Feed	● OK	Ethernet 2	MPTS Manual Rate	● Error
Encoder 2	NBC Feed	● OK	Ethernet 2	MPTS Manual Rate	● Error
Encoder 1	CBS Feed	● OK	ASI 1	Primary Modulator	● OK
Encoder 2	NBC Feed	● OK	ASI 1	Primary Modulator	● OK
Encoder 1	CBS Feed	● OK	ASI 2	Fiber Link	● OK
Encoder 2	NBC Feed	● OK	ASI 2	Fiber Link	● OK

### ***MPTS Configuration Tab***

If two encoder channels are installed in the 9223-ENC, the MPTS Configuration Tab is available. This tab contains information specific to muxing the two encoders into one Multi-Program Transport Stream (MPTS).

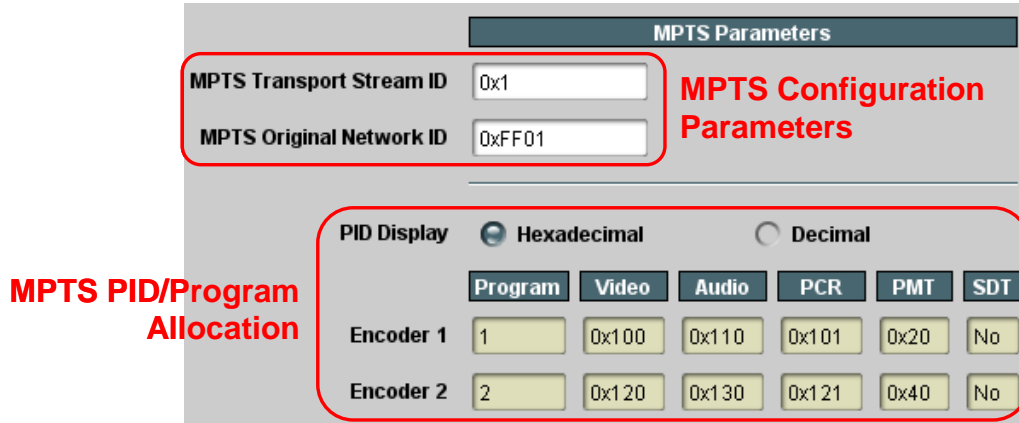

As indicated above, the MPTS Configuration Tab is divided into two distinct areas:

- The MPTS Configuration Parameters, which allow the setting of two MPTS-specific parameters.
- The MPTS PID/Program Allocation, which reports on the actual PIDs and Program numbers used in the MPTS.

## MPTS Configuration Parameters

Whenever possible, the MPTS uses the same parameters as configured in the individual encoders. However, there are two parameters that need to be independently set, as follows:

- **MPTS Transport Stream ID:** This field sets the Transport Stream ID for the MPTS formed by multiplexing the two encoders. This field accepts both hexadecimal (starting with 0x) and decimal entries. Valid values are from 0 (0x0) to 65535 (0xFFFF).
- **MPTS Original Network ID:** This field set the Original Network ID to be reported in the MPTS SDT (if enabled). For a discussion of how to set the Original Network ID, please see the SDT description in Advanced Tab – Mux Parameters in the Encoder chapter.

MPTS Transport Stream ID	4
MPTS Original Network ID	0xFF01

Note that this window does not have an **Apply** button; changes take effect immediately and on-the-fly.

## MPTS PID/Program Allocation

Since the PIDs and Program Numbers can be set arbitrarily in each encoder, it is possible to select the same values for one or more of these parameters between Encoder 1 and Encoder 2. However, when the bitstream from the encoders is multiplexed into one MPTS, these values have to be distinct.

When building the MPTS, the 9223-ENC will use the configured values for each encoder if at all possible. However, if there are any conflicts, the following rules are employed:

1. The PID/Program allocations made for Encoder 1 are used unchanged in the MPTS.
2. If any PIDs configured for Encoder 2 conflict with those from Encoder 1, the Encoder 2 PIDs are remapped to the closest free value. Note that this remapping only happens for the MPTS; ports carrying the bitstream for Encoder 2 only will use the configured values.
3. If the program number is the same for Encoder 1 and Encoder 2, the program number for Encoder 2 in the MPTS will be that of Encoder 1 plus 1. For example, if both encoders are configured to be program 4, Encoder 1 will be program 4 in the MPTS, and Encoder 2 will be program 5 in the MPTS. Both encoders will still be program 4 in their individual SPTS.
4. The MPTS will have an SDT if either Encoder 1 and/or Encoder 2 have the SDT enabled. If only one encoder has the SDT enabled, the MPTS SDT will have only one entry, for that encoder.

The MPTS PID/Program Allocation area reports the actual PIDs and Program Numbers being used in the MPTS. It also reports whether or not the individual SDTs are enabled per encoder.

The screenshot shows the 'PID Display' control set to 'Hexadecimal'. Below it are buttons for 'Program', 'Video', 'Audio', 'PCR', 'PMT', and 'SDT'. The table below shows the configuration for Encoder 1 and Encoder 2.

	Program	Video	Audio	PCR	PMT	SDT
Encoder 1	1	0x100	0x110	0x101	0x20	No
Encoder 2	2	0x120	0x131	0x121	0x40	Yes

The **PID Display** control determines whether PIDs are displayed in Hexadecimal or Decimal.

The screenshot shows the 'PID Display' control set to 'Decimal'. Below it are buttons for 'Program', 'Video', 'Audio', 'PCR', 'PMT', and 'SDT'. The table below shows the configuration for Encoder 1 and Encoder 2.

	Program	Video	Audio	PCR	PMT	SDT
Encoder 1	1	256	272	257	32	No
Encoder 2	2	288	305	289	64	Yes

If more audio channels are enabled, their respective PIDs will be displayed as well:

The screenshot shows the 'PID Display' control set to 'Hexadecimal'. Below it are buttons for 'Program', 'Video', 'Audio 1', 'Audio 2', 'Audio 3', 'Audio 4', 'PCR', 'PMT', and 'SDT'. The table below shows the configuration for Encoder 1 and Encoder 2.

	Program	Video	Audio 1	Audio 2	Audio 3	Audio 4	PCR	PMT	SDT
Encoder 1	1	0x100	0x110	0x111	0x112	0x113	0x101	0x20	No
Encoder 2	2	0x120	-	-	-	-	0x121	0x40	No

If SMPTE-2038 and/or SCTE-35 are enabled, their respective PIDs will be displayed as well:



PID Display  Hexadecimal  Decimal

	Program	Video	Audio 1	Audio 2	Audio 3	Audio 4	PCR	PMT	SCTE 35	SMPTE 2038	SDT
Encoder 1	1	0x100	0x110	0x111	-	-	0x101	0x20	0x102	0x103	Yes
Encoder 2	2	0x120	0x130	-	-	-	0x121	0x40	-	-	No

### **MPTS Statistics Tab**

The MPTS Statistics Tab has the exact same information as the MPTS Configuration Tab. PIDs are displayed in Decimal or Hexadecimal depending on the setting in the configuration tab.

MPTS Parameters	
MPTS Transport Stream ID	4
MPTS Original Network ID	0xFF01

  

	Program	Video	Audio	PCR	PMT	SDT
Encoder 1	1	256	272	257	32	No
Encoder 2	2	288	305	289	64	Yes

---

## Admin Tab

The Admin tab contains several general administrative functions, each on its own tab. The general layout is shown below:

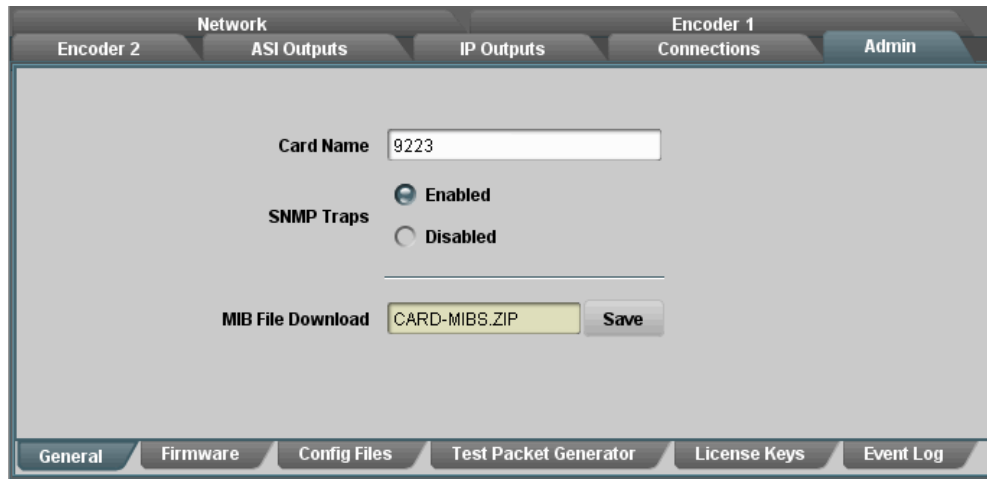

The Admin tabs are:

- **General:** Manages a number of general parameters; provides an SNMP MIB download.
- **Firmware:** Manages firmware images.
- **Config Files:** The 9223-ENC has the ability to store multiple configurations, and it has a number of pre-set configurations as well. These are managed in this tab.
- **Test Packet Generator:** Manages the Test Packet Generators.
- **License Keys:** Contains the current licensing state of the 9223-ENC, and allows for new license keys to be entered.
- **Event Log:** The 9223-ENC contains a non-volatile event log. It can be inspected and downloaded from this tab.

The Admin Statistics tabs are simplified read-only versions of the corresponding Admin Configuration tabs. They will not be explicitly described here.

### **Admin General Tab**

The Admin General Tab includes the following parameters:

**Note:** Illustrations below may show models other than 9223-ENC. Illustrations are examples, with 9223-ENC appearing identically.

- **Card (device) Name:** This field defaults to the device model but can be set to any descriptive name. The name provided here will also appear in the Dashboard™ Tree View.

- 
- **SNMP Traps:** This allows SNMP traps to be enabled or disabled<sup>5</sup>. Note that this setting does not take effect immediately – it will become active the next time the unit is rebooted.
  - **Enable Parameter Blast:** This a feature that speeds up DashBoard startup over high-latency links (i.e., when the computer running DashBoard has a WAN connection to the encoder or the frame housing the encoder). This feature requires DashBoard version 8.2 or later.
  - **MIB File Download:** The 9223-ENC provides an up-to-date copy of its MIBs. If you click on the **Save** button, a zip file with the relevant MIBs will be downloaded to your computer. This zip file contains the unit MIBs, as well as the Ross Video and openGear MIBs required to compile the unit MIBs.

The Admin General Tab is depicted below:

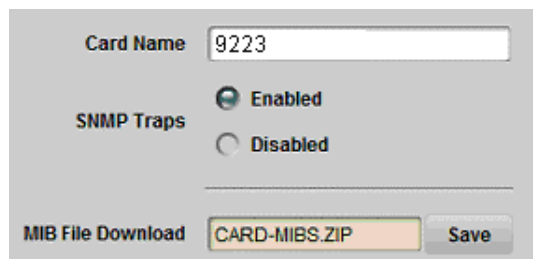

The screenshot shows a web interface for configuring a unit. It features a text input field for 'Card Name' containing the value '9223'. Below this is a radio button selection for 'SNMP Traps', with 'Enabled' selected. At the bottom, there is a 'MIB File Download' section with a button labeled 'CARD-MIBS.ZIP' and a 'Save' button.

## **Admin Firmware Tab**

The 9223-ENC can hold up to three distinct firmware images: a **Factory** image, and two upgrade images, called **Image 1** and **Image 2**. The Factory image can never be overwritten, and will always be available as a fall-back in case of problems or failed updates. Image 1 and Image 2 can be updated at will. Since the card in the unit offers two upgrade images, it is always possible to fall back to the previous image if there are any problems with the current one. The unit will also automatically fall back to the factory image if it detects a corrupted firmware image.

## **Uploading a Firmware Upgrade**

When applicable, Cobalt Digital Inc. provides for continual product enhancements through software updates. As such, functions described in this manual may pertain specifically to units loaded with a particular software build. You can update your unit by downloading the new Update software by going to the Support>Firmware link at [www.cobaltdigital.com](http://www.cobaltdigital.com). Download “Firmware Update Guide”, which provides simple instructions for downloading the latest firmware for your unit onto your computer, and then downloading it to your unit through

---

<sup>5</sup> SNMP is an optional feature in the openGear™ frame controller. The BBG-1123-ENC SNMP functions are only available if SNMP is licensed in the frame controller.

DashBoard™. When the firmware upgrade file is placed in the desired location on your computer click on the Upload button, as shown below. A dialog box allows you to select the upgrade file. Note that you can simultaneously upgrade all of your 9223-ENC units over multiple chassis if you wish.

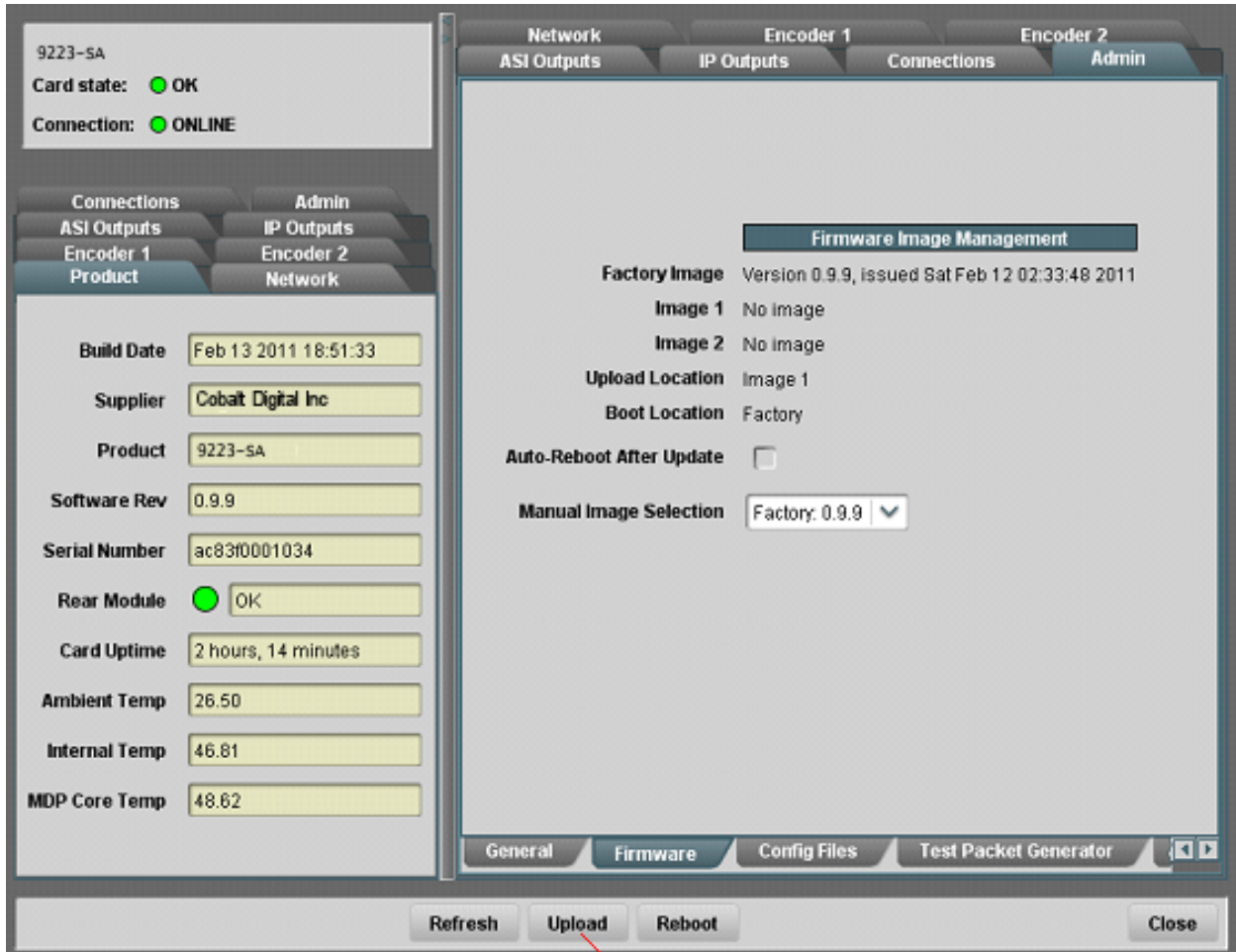

**Click here to start firmware update**

Note that uploading firmware to the 9223-ENC does not affect its operation in any way and does not introduce any glitches in the inputs/outputs.

**Note:** To allow for a controlled transition to operation when upgrading firmware, reboot the unit to engage the new firmware. The unit will go off-line while rebooting.

The fields in the Firmware Image Management tab are:

- **Factory Image, Image 1, and Image 2:** These contain version and release date information for the corresponding firmware images. If no image is present, this field will indicate **No Image**.

- 
- **Upload Location:** This field contains the location where the image upload will go. The 9223-ENC automatically chooses a location that will not overwrite the currently running image.
  - **Boot Location:** This field indicates which image will be used in the next boot. If an image is successfully uploaded through DashBoard, this automatically changes to point to that image. It can also be manually changed.
  - **Auto-Reboot After Update:** This field controls whether or not the 9223-ENC will automatically reboot after a successful firmware upload through DashBoard. By default, the 9223-ENC will **not** reboot after an update. You can upload the firmware at any time, and reboot later during a maintenance window.

### ***Admin Config Files Tab***

As you make configuration changes to the 9223-ENC, they are automatically persisted in non-volatile storage. If the unit is rebooted or power-cycled, it will come back in the same configuration.

In addition to automatic configuration persistency, the 9223-ENC also offers the ability to save up to 5 complete configurations, load them, and even export them. This can be used to quickly configure it for different scenarios, or for saving configuration “checkpoints” as a complex configuration is built. Since configurations can be exported, they can be archived outside the unit as well.

Finally, the 9223-ENC also offers 5 pre-saved configuration templates for some common scenarios.

The layout of the Admin Config Files tab is shown below.

The image shows two screenshots from a network management interface. The top screenshot, titled "Configuration Management", displays a table with five rows of configurations. The first row is labeled "Saved" and "Manual Example", while the others are "Empty". Each row has buttons for "Load", "Delete", "Save", and "Download Config". A red box highlights the entire table, and a red arrow points from the "Saved configuration 2" label to the second row. The bottom screenshot, titled "Preset Configurations", shows a table with five rows of pre-defined templates. Each row has a "Load" button. A red box highlights the table, and a red arrow points from the "Pre-Defined Templates" label to the table. Below the "Preset Configurations" table is a "Clear Current Configuration" button. A red box highlights a small area below the "Clear Current Configuration" button, with a red arrow pointing to the "Status Message Areas" label.

Config	Status	Name	Config	Config	Config	Download Config
1	Saved	Manual Example	Load	Delete	Save	Slot 5 9223 Config 1.ogd Save
2	Saved	IPTV Distriburion	Load	Delete	Save	Slot 5 9223 Config 2.ogd Save
3	Empty		Load	Delete	Save	Slot 5 9223 Config 3.ogd Save
4	Empty		Load	Delete	Save	Slot 5 9223 Config 4.ogd Save
5	Empty		Load	Delete	Save	Slot 5 9223 Config 5.ogd Save

Status	Description	Template
OK	Composite to Ethernet 1, 2 and ASI	Load
OK	SD-SDI to Ethernet 1, 2 and ASI	Load
OK	720p to Ethernet 1, 2 and ASI	Load
OK	1080i to Ethernet 1, 2 and ASI	Load
OK	1080i+SD from Video 1 to Eth 1, 2, ASI	Load

**Annotations:**

- Saved configuration 2:** Points to the second row in the Configuration Management table.
- User-Saved Configurations:** Points to the Configuration Management table.
- Pre-Defined Templates:** Points to the Preset Configurations table.
- Status Message Areas:** Points to a small box below the Clear Current Configuration button.

## User-Saved Configurations

The fields in the user-saved configuration are:

- **Status:** This indicates whether there is a saved configuration for the unit. It will contain the words **Saved** or **Empty**.
- **Name:** This is an optional name for the configuration. It is not required but highly advisable. The name can be edited at any time (even when there is no saved configuration).

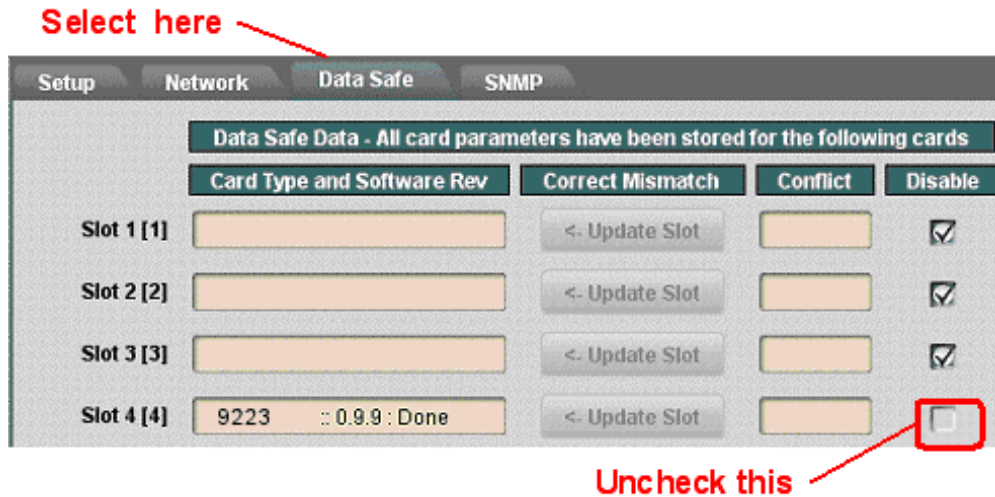

- **Config Load Button:** If you click on this button, the corresponding configuration is loaded in the 9223-ENC. It will replace the currently-running configuration. DashBoard™ will take a few seconds to reload (longer if you are accessing over a wide-area network), but the actual configuration in the 9223-ENC is virtually instantaneous. The Status Message Area will indicate the result of the operation.
- **Config Delete Button:** If you click on this button, the corresponding configuration and its description are deleted.
- **Config Save Button:** If you click on this button, the current configuration is saved on the corresponding slot, possibly replacing the configuration saved there if it is not empty.
- **Download Config:** If you click on the **Save** button, the corresponding file is downloaded to your computer. This feature is provided to allow configuration backups.

If you save a configuration to your computer, and later wish to restore it to the 9223-ENC, use the following procedure:

1. On DashBoard™, open the user interface for this device.
2. Select the **Data Safe** tab in the configuration area.
3. Uncheck the **Disable** checkbox corresponding to the unit you wish to restore the configuration. This step is depicted below.

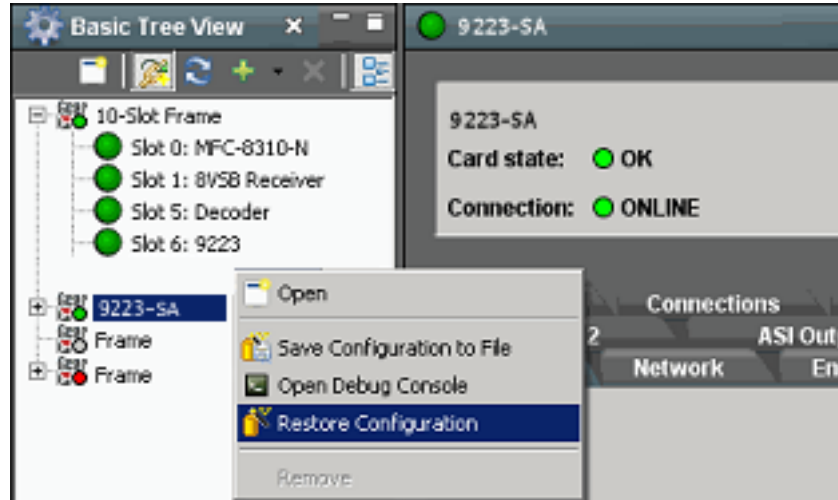

4. On the DashBoard™ Tree View, right-click on the unit, and select **Restore Configuration**. Follow the prompts and navigate to the file you wish to restore. This process is illustrated below

This process is discussed in further detail in the **DashBoard User Manual**, chapter 5, section **Restoring Configurations to Devices**.

## Pre-defined Templates

The 9223-ENC offers 5 pre-defined configuration templates, as indicated below.

Status	Description	Template
OK	Composite to Ethernet 1, 2 and ASI	Load
OK	SD-SDI to Ethernet 1, 2 and ASI	Load
OK	720p to Ethernet 1, 2 and ASI	Load
OK	1080i to Ethernet 1, 2 and ASI	Load
OK	1080i+SD from Video 1 to Eth 1, 2, ASI	Load

To load a template, just click on the **Load** button next to it. The pre-defined templates are;

- **Composite to Ethernet 1, 2 and ASI:** This template configures both encoders to run from composite inputs (Encoder 1 from Video 1, Encoder 2 from Video 2). Encoders are routed to individual multicasts on both Ethernet ports, and as an MPTS to both ASI Ports.



- **SD-SDI to Ethernet 1, 2 and ASI:** This template configures both encoders to run from SD-SDI inputs (Encoder 1 from Video 1, Encoder 2 from Video 2). Encoders are routed to individual multicasts on both Ethernet ports, and as an MPTS to both ASI Ports.
- **720p to Ethernet 1, 2 and ASI:** This template configures both encoders to run from HD-SDI 720p inputs (Encoder 1 from Video 1, Encoder 2 from Video 2). Encoders are routed to individual multicasts on both Ethernet ports, and as an MPTS to both ASI Ports.
- **1080i to Ethernet 1, 2 and ASI:** This template configures both encoders to run from HD-SDI 1080i inputs (Encoder 1 from Video 1, Encoder 2 from Video 2). Encoders are routed to individual multicasts on both Ethernet ports, and as an MPTS to both ASI Ports.
- **1080i + SD from Video 1 to Eth 1, 2, ASI:** This template configures both encoders to run from an HD-SDI 1080i input connected to Video 1. Encoder 1 runs at full resolution, Encoder 2 downscales the content to SD. Encoders are routed to individual multicasts on both Ethernet ports, and as an MPTS to both ASI Ports.

### Clear Current Configuration Button

The **Clear Current Configuration** button clears all the configured ports and streams as follows:

- All ASI Ports are set to manual configuration, 20 Mb/s, 188-byte packets.
- All Encoders are stopped and configured with a default set of parameters.
- All IP Outputs are deleted.
- All Connections are removed.
- The Test Packet Generators are disabled.

The button does not affect the following areas:

- The settings in the **Network** tab are not changed.
- The settings in the **Admin General** tab are not changed.
- Saved configurations are not modified in any way.

DashBoard™ will take a few seconds to reload (longer if you are accessing over a wide-area network), but the actual configuration in the 9223-ENC is virtually instantaneous. The Status Message Area will indicate the result of the operation.

### Admin Test Packet Generator Tab

The 9223-ENC includes two Test Packet Generators (TPG) that are capable of generating a configurable constant bit rate sequence of MPEG-2 Transport Packets with very strict timing. The TPGs are considered a source (input), and are available to be connected to any output. The user interface for the TPGs includes a current status table, which reports the current configuration of the generators.

Test Packet Generators					
	Mode	PID	Bit Rate (b/s)	Port Name	Edit
TPG 1	Disabled	0x80	0	TPG 1	Edit
TPG 2	Disabled	0x81	0	TPG 2	Edit

To configure one of the TPGs, click on the **Edit** button on its row. The following configuration parameters are displayed:

The screenshot shows the 'TPG 1 Configuration' window. It is divided into two main sections, both highlighted with red rounded rectangles. The top section, 'TPG Configuration Parameters', includes a 'Port Name' field with 'TPG 1', a 'Mode' section with radio buttons for 'Disabled' (selected), 'NULL Packets', 'Ramp48 Packets', and 'PCR Packets', a 'PID' field with '0x80', and a 'Bit Rate' field with '64000'. The bottom section, 'Output Selection Connection Parameters', features a 'Stream Display' section with radio buttons for 'Stream Names' (selected) and 'Stream Addresses'. Below this is a table with columns 'Port', 'Name', and 'Connect'. The table lists six connections: Ethernet 1 (SPTS From Encoder 1), Ethernet 1 (Encoder 1 NULL-padded), Ethernet 2 (MPTS Auto Rate), Ethernet 2 (MPTS Manual Rate), ASI 1 (Primary Modulator), and ASI 2 (Fiber Link). Each row has a 'Connect' checkbox. At the bottom are 'Apply' and 'Cancel' buttons.

Port	Name	Connect
Ethernet 1	SPTS From Encoder 1	<input type="checkbox"/>
Ethernet 1	Encoder 1 NULL-padded	<input type="checkbox"/>
Ethernet 2	MPTS Auto Rate	<input type="checkbox"/>
Ethernet 2	MPTS Manual Rate	<input type="checkbox"/>
ASI 1	Primary Modulator	<input type="checkbox"/>
ASI 2	Fiber Link	<input type="checkbox"/>

The configuration interface is divided into two areas:

- **TPG Configuration Parameters**, described in this section.
- **Output Selection Connection Parameters**, described in the Destination Selection section of the Connections Tab chapter.

The TPG Configuration Parameters are:

- **Port Name:** All 9223-ENC ports have a user-defined name, to facilitate routing. Enter any suitable name.
- **Mode:** controls the type of MPEG-2 transport packets generated. The options are:
  - **Disabled:** TPG is disabled. No packets are being generated.
  - **NULL Packets:** TPG is generating NULL packets. If you select this option, the **PID** parameter becomes read-only with the value 1FFF.

- **Ramp48 Packets:** TPG is generating packets with a “Ramp48 Payload”. A “Ramp48 Payload” is composed of the bytes 0x48, 0x49, 0x4A, ..., 0xFF. Generated packets have the Payload bit set, no Adaptation Field, and a valid Continuity Counter field.
- **PCR Packets:** TPG is generating packets with a valid PCR field (stamped corresponding to the packet’s departure time at the configured bit rate). The packets have a small payload with random data, so the Continuity Counter field is valid and counting.
- **PID:** controls the PID of the generated packets. This field accepts both decimal and hexadecimal values (prefixed with 0x).
- **Bit Rate (bps):** controls the bit rate of the generated packets. The minimum value is 64,000 bps and the maximum value is 213,000,000 bps.

## ***Admin License Keys Tab***

The 9223-ENC has a number of optional licensable features. The Admin License Keys Tab is used to manage these features. Using this tab, you can see how many licenses you have for each optional feature, and how many you are currently using.

The Admin License Keys Tab includes a License Status table, and a configuration area, as shown below. The table rows are license counts, and the columns correspond to different licensable features. The rows are:

- **Permanent Licenses:** This is the number of non-expiring licenses for each feature.
- **Temporary Licenses:** This is the number of temporary licenses for each feature. Once the license period expires, they are removed.
- **Total Licenses:** This is the total number of licenses for each feature. It is simply the sum of the permanent and temporary licenses.
- **Used Licenses:** This is the number of licenses in use for each feature by the current configuration.

If you have temporary licenses, the **Time Remaining** field indicates how long until they expire. If you do not have temporary licenses, this field has the message “No active temporary licenses”.

The table columns correspond to the licensable features, as follows:

- **AAC-LC Pairs:** The 9223-ENC requires one license per instance of AAC-LC stereo encoding. (**Note:** AAC is required for OTT applications.)
- **Extra MP2 Pairs:** One MPEG-1 Layer II license is included with each encoder channel. This field counts the additional licenses.
- **SD Instances, HD/1080i Instances, HD/1080p Instances:** The maximum output resolution for the 9223-ENC is subject to licensing. Note that if the encoder has a license for a particular resolution, that license is good for any lower resolution as well.
- **OTT Protocols:** OTT (Over-The-Top) Protocols are HTTP Live Streaming and RTMP. Licenses in this column are applicable to both protocols. Each instance of either protocol

requires a license. OTT licenses are provided at no cost, please contact support with your encoder serial number if you would like to enable these protocols. However, please note that RTMP only supports AAC-LC audio; the encoder must have AAC-LC licenses to run RTMP. The HLS protocol does not require AAC-LC, but many mobile devices that support HLS only work with AAC-LC. This is the case for most Apple devices.

- **SMPTE 2022 FEC:** This enables FEC for the unit. This is not a counted feature; if FEC is enabled, the corresponding number is 1; if it is disabled, the corresponding number is 0. The Used Licenses field will be set to 1 if there is at least one FEC instance in use.
- **RIST:** This enables RIST for the board. This is not a counted feature; if RIST is enabled, the corresponding number is 1; if it is disabled, the corresponding number is 0. The Used Licenses field will be set to 1 if there is at least one RIST instance in use.

License Status								
Feature	AAC-LC Pairs	Extra MP2 Pairs	SD Instances	HD/1080i Instances	HD/1080p Instances	OTT Protocols	SMPTE 2022 FEC	RTP/ARQ
Permanent Licenses	2	2	0	0	2	2	1	1
Temporary Licenses	2	2	0	0	2	2	1	0
Total Licenses	4	4	0	0	4	4	1	1
Used Licenses	0	2	0	0	1	0	0	0
Time Remaining	3 weeks, 6 days, 23 hours							
License Key	<input type="text"/>							
	<input type="button" value="Apply License Key"/>							
Serial Number	ac83f000226c							

To request a license key from Cobalt, you will need to provide the unit serial number. It can be found in the Product Tab and in the Admin License Key Tab as well. Once you receive the key from us, enter it in the **License Key** field shown above, and click on the **Apply License Key** button. If the key is accepted, you will see the message *License Key Installed OK*, as illustrated above. If there are any problems, you will see an error message in the same location. The following are the possible error messages:

- **Invalid key: missing characters:** the key you entered is too short. Double-check that you entered all the characters.
- **Invalid/Corrupted Key:** the key you entered has the correct number of characters, but it is invalid. Double check what you entered.
- **Serial number mismatch: this key is for serial xxxxxxxxxxxx:** 9223-ENC license keys are specific to a unit. You entered a valid license key, but it is intended for a different unit, whose serial number is displayed in the message. You must use this key on the correct unit.
- **This key has already been applied:** License keys can only be applied once. This is a valid key for this unit, but you have already applied it, and its features are already available.

---

## Admin Event Log Tab

The 9223-ENC includes an Event Log in non-volatile storage. This event log can be used for fault-finding, and to check for error conditions. The following information is included in each 9223-ENC event in the log:

- **Date:** The calendar date in which the event occurred.
- **Time:** The time at which the event occurred.
- **Severity:** The severity of the event. The 9223-ENC defines three severity levels:
  - **Error:** These are events that affect the operation of the device. For example, an ASI Input losing lock or an IP Input no longer receiving packets. An error will impact service until addressed.
  - **Warning:** These are events that may produce visible glitches, but they do not have a continuous service impact. Examples of warnings are automatic redundancy switches and ARP renewal failures.
  - **Info:** These are informational events. All configuration actions are logged with this severity. When an error is cleared (for example, an ASI Input regains lock), the event is logged with this severity as well.
- **Subsystem:** The subsystem affected by the event. This may be a port, a stream, or the unit itself.
- **Event:** This is a textual description of the event.

The 9223-ENC does not have a battery-backed real-time clock. It can use an external Network Time Protocol (NTP) server to obtain current date and time. By default, the 9223-ENC will initialize its internal time-of-day clock to January 1, 2010, GMT.

For the BBG-1123/9223-SA, the NTP server IP address can be entered in the Control Port Configuration Tab.

The 9223 openGear card depends on the frame controller to obtain the current date and time, and the frame controller depends on an external Network Time Protocol (NTP) server to obtain current date and time.

In order to configure the openGear chassis frame controller for NTP, open its configuration screen on Dashboard™, select the **Network** Tab, and enter the IP address of an available NTP server:

Select this

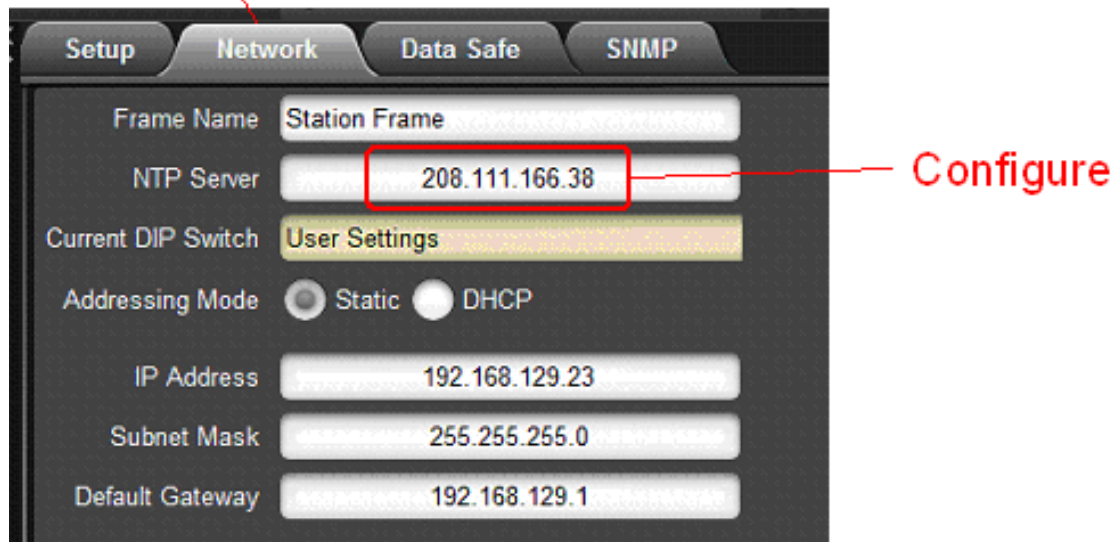

If your device (or frame controller, in case of the 9223) has access to the Internet, you can point it to one of the public NTP servers for your region. You can find more details on this link:

<http://psp2.ntp.org/bin/view/Servers/WebHome>

The full Admin Event Log tab is displayed below:

Log Download 9223-SA Log.csv Save

Log View  All  Error  Warning  Info

Event Log				
Date	Time	Severity	Subsystem	Event
02/02/11	13:14:13	Info	IP Out 2/1	Configured: 226.1.2.1:1024 Pad 15000000 TTL 128 TOS 0 DF set enabled
02/02/11	13:14:04	Info	IP Out 1/1	Configured: 226.1.1.1:1024 Pad 15000000 TTL 128 TOS 0 DF set enabled
02/02/11	10:56:34	Info	System	DataSafe restore finish
02/02/11	10:56:34	Info	System	Time zone changed to GMT-8
02/02/11	10:56:34	Info	Ethernet 2	Configured: IGMP version set to Auto-Detect
02/02/11	10:56:34	Info	Ethernet 2	Configured: Alarm on Link Loss Enabled
02/02/11	10:56:34	Info	Ethernet 2	Configured: address 10.10.10.116 mask 255.255.255.0 gateway 0.0.0.0
02/02/11	10:56:34	Info	Ethernet 1	Configured: IGMP version set to Auto-Detect
02/02/11	10:56:34	Info	Ethernet 1	Configured: Alarm on Link Loss Enabled
02/02/11	10:56:34	Info	Ethernet 1	Configured: address 10.10.9.116 mask 255.255.255.0 gateway 0.0.0.0

Time Zone GMT-8

Current Time Thu Feb 3 11:16 2011

Clear Log Display

Notes EN460 time starts at 01/01/2010, 00:00  
EN460 will accept NTP from control card

The fields are:

- **Log Download:** The user interface only displays the last 10 events of each type. If you would like to see the whole event log, it can be downloaded to your computer by clicking on the **Save** button. The log will be in CSV format, and it can be opened by any utility that can read text files; ideally, you should use a spreadsheet program such as Microsoft Excel or similar so it is presented in tabular format. The log will be in chronological order, oldest entry to newest.
- **Log View:** The user interface can display the last 10 events. You can choose to see the last 10 events of any kind by selecting **All**, or you can restrict the view only to **Info**, **Warning**, or **Error**.
- **Event Log:** This table presents the last 10 events of the selected type.
- **Time Zone:** To simplify the correlation of the events with your local time, you can set your time zone using this drop-down menu. Note that the 9223-ENC presents a simplified list, with standard GMT offsets. Note that standard GMT offsets do not change back and forth with Daylight Savings; you will need to make this adjustment manually if it is relevant to you.
- **Current Time:** This field indicates the 9223-ENC view of what the current date and time is. If your frame is not NTP-synchronized, this is useful to figure out “how long ago did this event happen”.

- 
- **Clear Log Display:** If you click on this button, it clears all log views. This is useful to quickly identify any new events after the unit has been set up. Note that this action does not clear the logs stored in non-volatile memory.

The 9223-ENC will store up to about 400 kbytes of logs in non-volatile memory. When that limit is reached, the oldest half of the stored logs will be deleted to make space for new logs.



---

## Control Tab

The Control Tab is used to configure the management Ethernet ports in the BBG-1123-ENC or 9223-SA. This includes both the IP information, as well as the SNMP parameters.

The BBG-1123-ENC/9223-SA has two physical management (control) Ethernet ports. However, from a logical standpoint, they are a single port with a single IP address; the two connections are provided for control redundancy. If one port loses link, the unit can still be controlled from the other. If you do not need control redundancy, you can leave one of the ports disconnected. The unit will automatically and dynamically select the control port as follows:

- If only one port has link, that port will be used for control.
- If both ports have link, but at different speeds, the port with the highest speed will be used for control.
- If both ports have link at the same speed, Port 1 will be used for control.

Both ports support operation at 10, 100 and 1000 Mb/s, both half-duplex and full-duplex, with auto-negotiation and auto-crossover detection.

The Control Tab has two bottom tabs:

- **Control Port** is used to configure the IP parameters of the control port.
- **SNMP** is used to configure the SNMP parameters for the unit.

### ***Control Port Configuration Tab***

The control configuration window is depicted below:

The screenshot shows a configuration window for a device named "Standalone Encoder". The window has a title bar "Control Interface Configuration". Under "IP Configuration", the "Static IP" radio button is selected, and the "DHCP" radio button is unselected. Below this, there are four text input fields: "IP Address" with the value "192.168.129.103", "Subnet Mask" with "255.255.255.0", "Default Gateway" with "192.168.129.1", and "NTP Server" with "192.168.129.10". At the bottom of the window, there are two buttons: "Apply" and "Cancel".

---

The configuration parameters are:

- **Device Name:** This field controls the top-level name of the device in the Dashboard tree. It defaults to “Standalone Encoder”. Changes to this field take effect immediately.
- **IP Configuration:** This field selects the control port IP configuration mode, as follows:
  - **Static IP:** This option selects a static IP address, specified by the IP Address, Subnet Mask, and Default Gateway fields.
  - **DHCP:** This option selects control port IP address configuration by DHCP. If this option is selected, the IP Address, Subnet Mask and Default Gateway fields are not shown.
- **IP Address:** This field is only shown if **IP Configuration** is set to **Static IP**. Enter the desired control port IP address.
- **Subnet Mask:** This field is only shown if **IP Configuration** is set to **Static IP**. Enter the desired control port subnet mask.
- **Default Gateway:** This field is only shown if **IP Configuration** is set to **Static IP**. Enter the desired control port default gateway.
- **DNS Server:** This field is only shown if **IP Configuration** is set to **Static IP**. Enter the desired DNS Server IP address. Note that DNS is only used for RTMP output. This field can be left at 0.0.0.0 if RTMP is not used. If you wish to configure more than one DNS server, you can enter them in the Network Configuration DNS Tab. If you configure DNS servers here and in the Network Configuration, the server specified here will be contacted first.
- **NTP Server:** If you want the unit to be NTP-synchronized (for logging purposes), enter the IP address of an accessible NTP server in this field. If you do not need NTP, you can leave this field at 0.0.0.0. If your BBG-1123-ENC/9223-SA has access to the Internet through the control port, you can point it to one of the public NTP servers for your region. You can find more details on this link:

<http://psp2.ntp.org/bin/view/Servers/WebHome>

- **Apply/Cancel:** Use these buttons to apply or cancel the changes to the control port IP configuration. Note that if you change the IP address, DashBoard may lose contact with the BBG-1123-ENC/9223-SA. The IP Address, Subnet Mask and Default Gateway entries will be checked for consistency and will be rejected if invalid.

### **Control Port Statistics Tab**

The Control Port statistics screen is depicted below. It contains the current settings for the control port. If you have configured the unit for DHCP, it will include the current IP Address, Subnet Mask and Default Gateway obtained from the DHCP server. It also includes the link state for the individual control Ethernet ports.

Device Name	Standalone Encoder
<b>Control Interface Configuration</b>	
IP Configuration	DHCP
IP Address	192.168.129.103
Subnet Mask	255.255.255.0
Default Gateway	192.168.129.1
NTP Server	192.168.129.10
Control 1 Link	<span style="color: green;">●</span> Link OK
Control 1 Speed	1 Gb/s Full Duplex
Control 2 Link	<span style="color: red;">●</span> No Link
Control 2 Speed	No Link

### **SNMP Configuration Tab**

The BBG-1123-ENC/9223-SA includes a built-in SNMP agent with support for SNMP V1 and V2C. It will respond to SNMP transactions only on the control port, for security reasons. This tab includes the parameters for the SNMP configuration. Changes to these parameters take effect immediately.

<b>SNMP Configuration</b>	
Read Community	public
Write Community	private
System Contact	Contact Not Set
System Location	Location Not Set
<b>Trap Destinations</b>	
Trap Destination 1	0.0.0.0
Trap Destination 2	0.0.0.0
Trap Destination 3	0.0.0.0
Trap Destination 4	0.0.0.0
Trap Destination 5	0.0.0.0

---

The SNMP parameters are as follows:

- **Read Community:** this is the SNMP Read-Only community string.
- **Write Community:** this is the SNMP Read-Write community string.
- **System Contact:** this configures the value for the MIB-II System variable System Contact. Whatever value entered here is returned for SNMP queries to that variable.
- **System Location:** this configures the value for the MIB-II System variable System Location. Whatever value entered here is returned for SNMP queries to that variable.
- **Trap Destinations:** the BBG-1123-ENC/9223-SA supports up to 5 trap destinations. Enter the desired IP addresses here. Note that the BBG-1123-ENC/9223-SA will only generate SNMP V2C traps.

### ***SNMP Statistics Tab***

The SNMP statistics tab displays the current SNMP configuration.

SNMP Configuration	
Read Community	public
Write Community	private
System Contact	Contact Not Set
System Location	Location Not Set
Trap Destinations	
Trap Destination 1	0.0.0.0
Trap Destination 2	0.0.0.0
Trap Destination 3	0.0.0.0
Trap Destination 4	0.0.0.0
Trap Destination 5	0.0.0.0

---

## Support Tab

If you need support with your product, you can contact Cobalt Digital Inc. by phone or e-mail:

- Phone number: +1 217 344-1243, Monday-Friday 8:00AM – 5:00PM Central Time
- E-mail: [support@cobaltdigital.com](mailto:support@cobaltdigital.com)

If you need to contact Technical Support, please be prepared to provide the following information:

1. A detailed description of the problem, and any actions taken to solve it.
2. A detailed description of the environment around the encoder. This includes the make and model of any connected devices being used, as well as the connection network (IP or ASI) between the encoder and any other devices.
3. The Technical Support information from the decoder itself. This is downloaded from the **Support** tab:



Select the **Support** Tab, and click on the **Save** button next to **Support Info Download**. This will create a file called **TECHSUPPORT . TXT** in the computer running DashBoard. Please e-mail this file to address shown.

The **TECHSUPPORT . TXT** file contains the following information:

- The current configuration of the unit
- A copy of the Event Log (which can also be obtained via the Admin Event Log Tab)

This file does not contain any information that would allow remote access to the unit.

---

## Playing Video on a Web Page

In general, there are two ways of playing video on a web page:

- Using a web-browser plugin  
or
- Using the HTML5 `<VIDEO>` tag, for browsers that support it

Unfortunately, the HTML5 standard did not actually specify what type of audio/video encoding and container was to be supported. Therefore, even though the current versions of all major browsers support the `<VIDEO>` tag, there is no single format that will work on all browsers. Moreover, since the 9223-ENC is an encoder designed primarily for the broadcast market, it uses the transport stream container, which is not supported natively by any browser. Therefore, it is not possible to use the HTML5 `<VIDEO>` tag with content generated by the 9223-ENC.

In order to play the bitstream coming from the 9223-ENC in a web page, a plugin with the appropriate audio, video and container support must be installed in the web browser. The Open-Source VideoLAN player includes appropriate plugins that will work with the bitstream coming from the 9223-ENC. The VideoLAN player can be downloaded from:

<http://www.videolan.org/vlc/>

There are two types of plugins:

- ActiveX controls, used by Internet Explorer
- “Mozilla” (Netscape) style plugins, used by most other browsers (Firefox, Chrome, Safari)

When installing the VideoLAN player, make sure to select the appropriate plugins for the browsers you intend to use. Note that the “Mozilla” style plugin is **not** installed by default. The figure below indicates the choices to be made during the VideoLAN installation in order to get the plugins installed on a Windows PC. If multiple browser support is required, both types of plugins can be selected (but at least one “Mozilla-style” browser must be already installed).

VideoLAN version 2.1.1 or later is recommended. Earlier versions had stability problems with the Mozilla plugin and did not support HTTP Live Streaming.

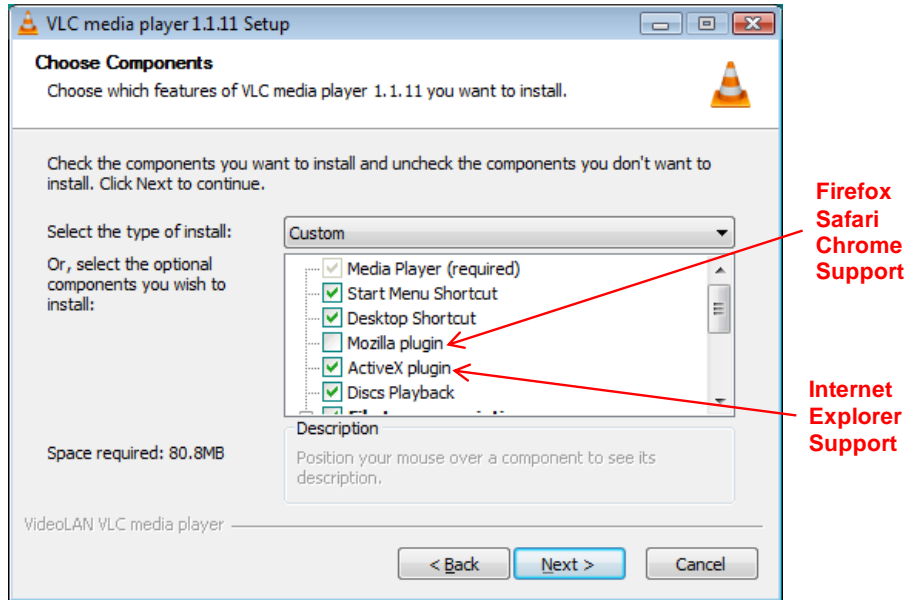

## **Web Pages Served by the 9223-ENC**

**Note:** Illustrations below may show models other than 9223-ENC. Illustrations are examples, with 9223-ENC appearing identically.

The 9223-ENC automatically generates web pages that will display the video being encoded, depending on the output mode of the encoder channels (please refer to the Encoder Connections Tab section). The pages will be available for the following output protocols:

- ASI/IP Streaming, as long as IP Outputs with multicast destination IP addresses have been defined.
- Direct HTTP Streaming.
- HTTP Live Streaming, when configured to use the local server.

The web pages generated by the 9223-ENC assume that the VideoLAN plugin has been installed to provide playback services.

To get started, simply point a web browser to the IP address of the desired 9223-ENC Ethernet port:

**[http://encoder\\_ip](http://encoder_ip)**

The 9223-ENC will respond with a Web page with the appropriate links to access the streams, depending on the current configuration. Note that the pages served by each Ethernet port may be different; for example, if the encoders are set to ASI/IP streaming, and no IP Outputs are defined for a given Ethernet port, the web page served from it will indicate that there are no streams available.

The next page shows a few examples of how these web pages look like, depending on the encoder settings.

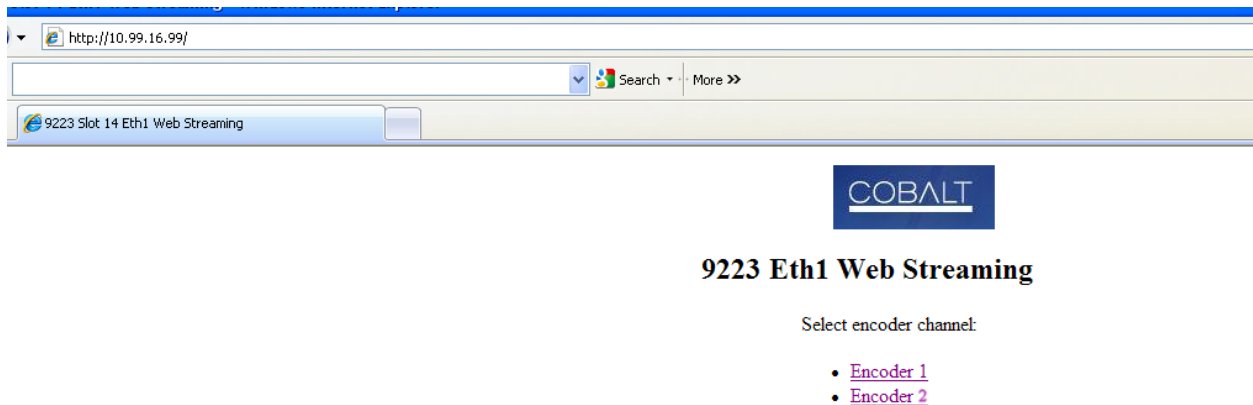
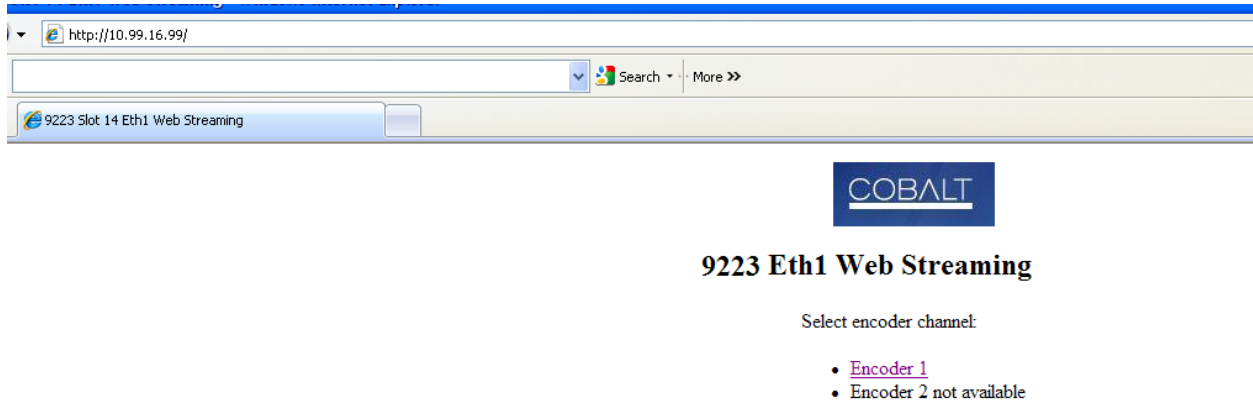
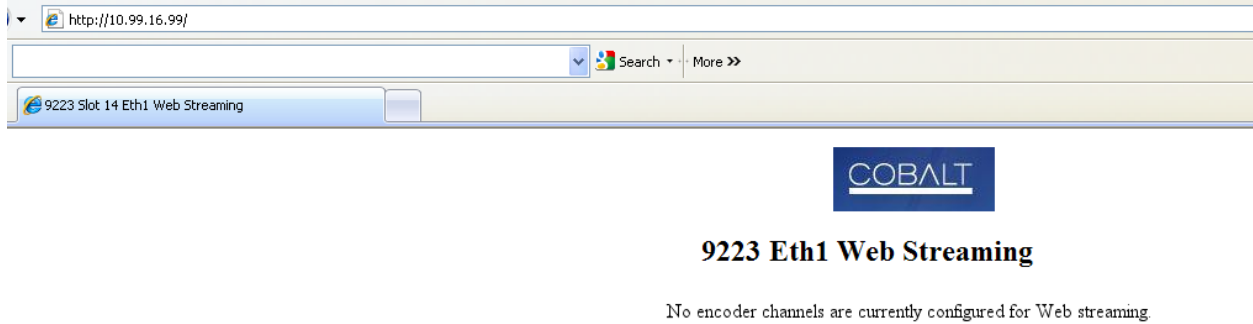

## Multicast Streaming

If an encoder is connected to IP Output ports configured for multicast streaming (i.e., with a destination IP address in the range of 224.0.0.0 to 239.255.255.255), the 9223-ENC will generate a web page for that output in the relevant Ethernet port. Note that the video will only actually



---

play if the network between the client and the encoder supports multicast. This will typically be the case if the encoder and the client are in the same subnetwork, but may not work across routers unless they have multicast support enabled, and will definitely not work across the Internet.

The relevant pages are shown below. Both UDP and RTP are supported.

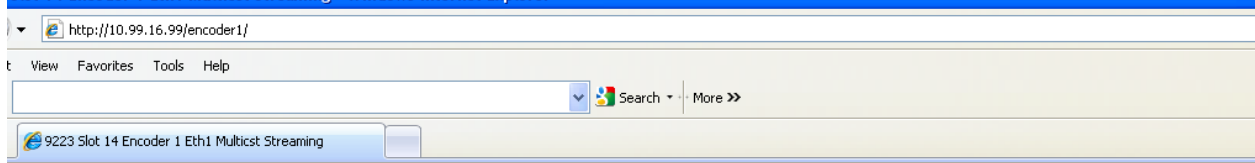

## 9223 Encoder 1 Eth1 Multicast Streaming

Select Multicast Flow:

- [Multicast: 226.2.4.10 Port: 49416 Protocol: RTP](#)

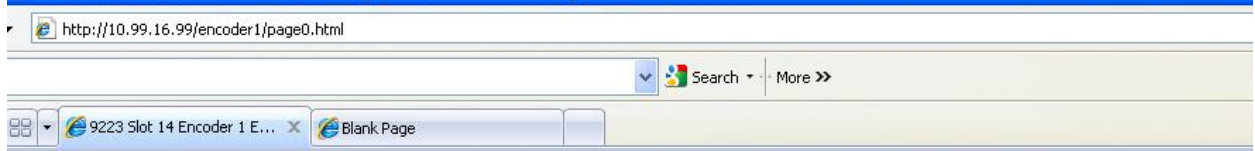

## 9223 Encoder 1 Eth1 Multicast Streaming



Multicast: 226.2.4.10 Port: 49416 Protocol: RTP  
Note: For MPTS streams, only the first program may be played

---

If you configure an MPTS stream (i.e., both encoders routed to the same IP Output), the page will be available for both encoders, but the plugin will only play the first channel (Encoder 1). Also, the plugin will only play the first audio PID, even if secondary audio is configured.

## HTTP Live Streaming

All the web pages accessible from the Ethernet ports of the 9223-ENC (and the Control port in the BBG-1123-ENC/9223-SA) include a link for the built-in HTTP Live Streaming server page.

If the IP address of the port being accessed is `xxx.xxx.xxx.xxx`, the available local HLS channels can also be accessed through this direct link:

`http://xxx.xxx.xxx.xxx/HLS/`

The page accessed through this link will display a list of available local HLS channels, with the value configured for **Program Name** as the label.

Note that HLS channels configured for remote servers will not be listed in this page, as the 9223-ENC has no way of knowing the actual link to these channels.

Clicking on the link will cause the content to play. For Apple devices (iPods, iPads, iPhones, etc.), this will launch the built-in media player; for PCs running Windows (and possibly Linux), if the VLC plugin is installed, the video will play in the web page.

## Direct HTTP Streaming

If an encoder channel is configured for Direct HTTP Streaming, clicking to select the encoder channel opens a browser containing the streaming video. Unlike multicast, Direct HTTP Streaming will work over the Internet as long as the path from the encoder to the client has sufficient bandwidth. Direct HTTP Streaming is always available on both Ethernet ports.

If the 9223-ENC is required to support clients on remote networks, make sure that a Default Gateway is entered in the corresponding Ethernet port configuration (see the The Network Tab allows for configuration/monitoring of the two streaming Ethernet ports, and optional configuration of DNS servers.

Network Configuration Tab section). When replying to a request, the 9223-ENC will always use the Ethernet port where it received the request from.

## Using a Firewall Between the 9223-ENC and the Internet

Since Direct HTTP Streaming works over the Internet, in some situations it may be desirable to do so (for example, to allow for remote monitoring). It is generally to be safe to connect the 9223-ENC Ethernet port directly to the Internet with a public IP address; however, this may not be desirable. It is possible to place a port-forwarding firewall between the 9223-ENC and the Internet; the web pages and the streaming will still work as long as the firewall is configured **not** to remap the Direct HTTP Streaming **Listening Port** (see the Direct HTTP Streaming

---

configuration section). For example, if the Listening Port is configured to be 8000, the firewall must be configured to remap external port 8000 to internal port 8000. The reason for this requirement is that the plugin needs to know the listening port, and that value is passed to it by the automatically-generated pages from the 9223-ENC.

## **Web Browser Support**

The web pages generated by the are known to work with the VideoLAN plugin versions 2.1.1 to 2.1.5 and the following web browsers (Windows):

- Internet Explorer versions 9.0.2 – 9.0.13
- Mozilla Firefox versions 7.0 – 19.0
- Google Chrome versions 14.0.835.186 – 24.0.1312.57
- Apple Safari 5.1 – 5.1.7

Other browsers and operating systems may work, as long as the VideoLAN plugin is installed.