

9501-DCDA-3G • Down-Converter/DA with 3G/HD/SD-SDI Input, Reclocking, SD-SDI and Analog Video/Audio Outputs

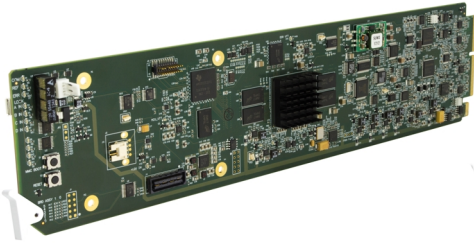

The **9501-DCDA-3G** provides 3G/HD-to-SD down-conversion with ARC and has versatility in providing up to four SD-SDI and/or analog composite outputs as well as up to four reclocked SDI input copies. The space-saving design of the 9501-DCDA-3G provides for high density, allowing two cards to be collocated in adjacent slots and served by a single, standard width “split” rear module. Up to 20 of the 9501-DCDA cards can be installed in a 20-slot frame.

The card can pass SD signals with re-aspect, if needed. AFD processing can detect an incoming AFD code and correspondingly set scaling to track with AFD. This processor also allows independent custom ARC to be applied for each incoming AFD code, and set the desired AFD code to be inserted on the output, even if there is no code detected on the input. Analog audio outputs can be de-embedded from selected embedded audio channels. The 9501-DCDA can rate-convert 23.98 frame video to 59.94 fields, move progressive to interlace and is equipped with extensive user programmable reticule overlays. Two discrete character burn strings can be inserted on output video, with each string inserted as static text and/or insert only upon LOS.

The data path is 10-bit with 12-bit analog encoding. Full proc control allows adjustment of luma gain, luma lift, color gain, and color phase. Preset save/load allows saving custom card settings while allowing one-button revert to factory settings.

Preset save/load allows saving custom card settings while allowing one-button revert to factory settings. Layered presets allow invoking changes related only to a specific area of concern (audio routing, for example) while not changing any other processing settings or aspects. Full user DashBoard™ or Remote Control Panel remote control allows full status and control access over a standard Ethernet network.

Alternate Base Model

• **9501-DCDA-HD** Down-Converter/DA with HD/SD-SDI Input, Reclocking, SD-SDI and Analog Video/Audio Outputs

FEATURES

Low power/high-density design allows up to 20 cards per frame; less than 18 Watts per card

Built-in x4 DAs for both reclocked and processed outputs

Dual SDI inputs with manual GUI select and basic failover function

Economical solution for 3G/HD down-conversion to legacy SD monitoring systems. HD version further economizes for environments requiring only HD/SD support (field upgradeable to 3G with software license upload if later desired).

Auto-format detect/down-conversion of SMPTE 424M/292/259M formats

Down-conversion scaling includes user-configurable ARC and AFD-controlled ARC

Color framing preserved on CVBS outputs for all conversions

User DashBoard output selection flexibly allows SDI or CVBS outputs on four processed-output BNCs

Dual independent text/character burn-in insertion allows condition-based insertion (such as basic ID text for valid input and different text message for failover/LOS conditions)

Full embedded audio control with selectable downmix and analog audio de-embed

Full timecode and CEA 708 / CEA 608 conversion to SD VITC timecode and closed-captioning. Option +LTC allows bidirectional transfer between embedded video timecode formats and audio LTC.

Remote control/monitoring via Dashboard™ software or OGCP-9000 remote control panels

Five year warranty

OPTIONS

3G Software Option Upgrade (+3G) – Upgrades 9501-DCDA-HD card to 9501-DCDA-3G functionality/specifications.

Color Correction (+COLOR) – Provides independent RGB channel controls for luma, black, and gamma. Ultra-fast response time. The color correction feature is perfectly suited for use with Cobalt OGCP-9000/CC Remote Control Panel.

Frame Sync Software Option (+FS) – Adds frame sync to 9501-DCDA-3G card. Provides full vertical and horizontal offset and frame delay controls. Glitch-free handling of embedded audio when a frame is dropped or duplicated.

Audio LTC Software Option (+LTC) – Offers bidirectional transfer and conversion between video timecode formats and audio LTC. Audio LTC can be received or sent over various card audio channels.

Extended Frame Sync Delay Option (+DLY) – Increases frame buffer to provide adjustable audio/video delay buffer capacity to over 9 seconds for SD video, 1.5 seconds for HD video, or 0.8 seconds for 3G video. Installation: Hardware feature available only on new card. (Add-on to option +FS; option +FS required)



9501-DCDA-3G • Down-Converter/DA with 3G/HD/SD-SDI Input, Reclocking, SD-SDI and Analog Video/Audio Outputs

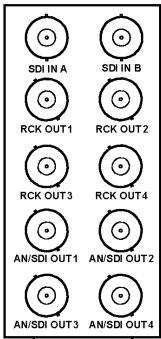
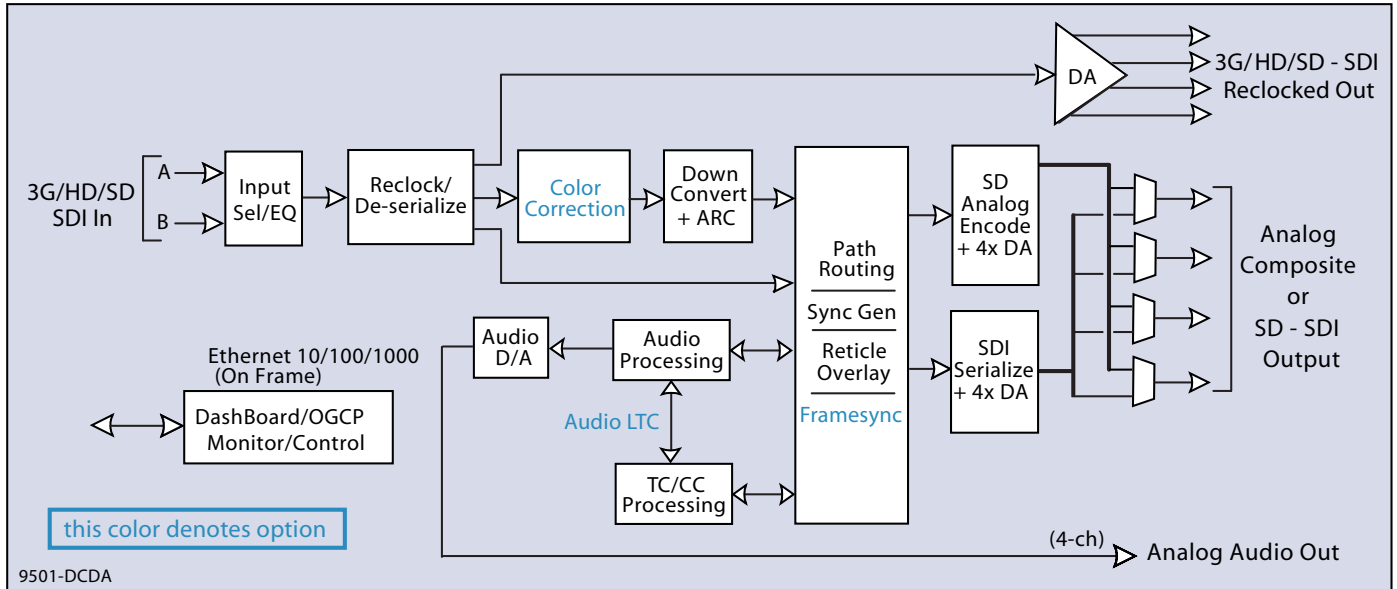

RM20-9501-A

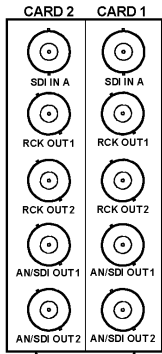

RM20-9501-AIS

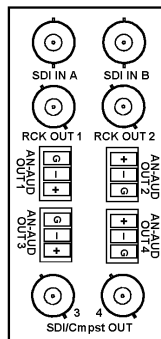

RM20-9501-B

Note: Although this rear module offers only two SDI/cm pst OUT BNCs, the two outputs on the rear module correlate to card output channels 3 and 4.

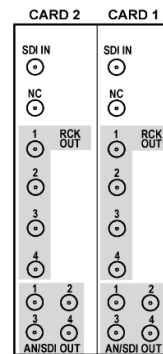

RM20-9501-CIS-DIN
RM20-9501-CIS-HDBNC

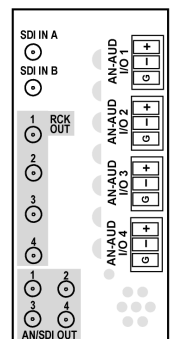

RM20-9501-F-DIN
RM20-9501-F-HDBNC

9501-DCDA-3G • Down-Converter/DA with 3G/HD/SD-SDI Input, Reclocking, SD-SDI and Analog Video/Audio Outputs

SPECIFICATIONS

Note: Inputs/outputs are a function in some cases of rear I/O module used.

Power

< 18 Watts

SDI Input

Number of Inputs: (2) 3G/HD/SD-SDI BNCs. GUI-selectable.
 Standards: SMPTE 259M, 292M, 424M (9501-DCDA-3G only)
 Supported Formats: 1080p59.94,50,29.97, 24, 23.98, 1080i59.94,50, 720p59.94,50,29.97, 24, 23.98, 625i, 525i
 Cable Length, Minimum, 3G/HD/SD (Belden 1694A): 120m / 180m / 360m
 Return Loss: 15 dB up to 1.485 GHz, 10 dB up to 2.970 GHz

Video Outputs

Number of Outputs: 4 dedicated reclocked output BNCs. Up to 4 processed SD-SDI (or CVBS output) BNCs. GUI-selectable.
 SDI Signal Level: 800 mV nominal
 SDI Return Loss: >15 dB up to 1.485 GHz, >10 dB up to 2.970 GHz
 SDI Jitter: SD: < 0.2 UI
 SDI Embedded Audio: 16-Ch

Frame Sync Audio/Video Delay (option +FS)

Max offset: 20 frames
 Latency (min): 1 frame
 Option +DLY Delay (3G/HD/SD): >800 msec / >1580 msec / >9000 msec

Reference Video Input

Number of Inputs: 2 looping (openGear® frame)
 Standard: Tri-level sync (SMPTE 274) and black burst (NTSC and PAL)

Analog Audio Output

Number of Outputs: 4-Ch (max) balanced using 3-wire Phoenix connectors
 Maximum Output Level: +24 dBu @ 0 dBFS
 DAC Resolution: 24-bit

ORDERING INFORMATION

9501-DCDA-3G Down-Converter/DA with 3G/HD/SD-SDI Input, Reclocking, SD-SDI and Analog Video/Audio Outputs

9501-DCDA-HD Down-Converter/DA with HD/SD-SDI Input, Reclocking, SD-SDI and Analog Video/Audio Outputs

RM20-9501-A 20-Slot Frame Rear I/O Module (Standard Width) (2) 3G/HD/SD-SDI Input BNCs, (4) 3G/HD/SD-SDI Reclocked Output BNCs, (4) Output BNCs (GUI-selectable as SD-SDI and/or Analog CVBS)

RM20-9501-A/S 20-Slot Frame Rear I/O Module (Split; supports 2 cards) 3G/HD/SD-SDI Input BNC, (2) HD/SD-SDI Reclocked Output BNCs, (2) Output BNCs (GUI-selectable as SD-SDI and/or Analog CVBS) (connections are per card)

RM20-9501-B 20-Slot Frame Rear I/O Module (Standard Width) (2) 3G/HD/SD-SDI Input BNCs, (2) 3G/HD/SD-SDI Reclocked Output BNCs, (2) Output BNCs (GUI-selectable as SD-SDI and/or Analog CVBS), (4) Analog Audio Outputs

RM20-9501-C/S-DIN 20-Slot Frame Rear I/O Module (Split; supports 2 cards) (2) 3G/HD/SD-SDI Input BNCs, (4) HD/SD-SDI Reclocked Outputs, (4) Outputs (GUI-selectable as SD-SDI and/or Analog CVBS) (connections are per card; all connectors DIN1.0/2.3)

RM20-9501-C/S-HDBNC 20-Slot Frame Rear I/O Module (Split; supports 2 cards) (2) 3G/HD/SD-SDI Input BNCs, (4) HD/SD-SDI Reclocked Outputs, (4) Outputs (GUI-selectable as SD-SDI and/or Analog CVBS) (connections are per card; all connectors HD-BNC)

RM20-9501-F-DIN 20-Slot Frame Rear I/O Module (Standard Width, Hi-Density) (2) 3G/HD/SD-SDI Inputs, (4) 3G/HD/SD-SDI Reclocked Outputs, (4) Outputs (GUI-selectable as SD-SDI and/or Analog CVBS), (4) Analog Audio Outputs (all coaxial connectors DIN1.0/2)

RM20-9501-F-HDBNC 20-Slot Frame Rear I/O Module (Standard Width, Hi-Density) (2) 3G/HD/SD-SDI Inputs, (4) 3G/HD/SD-SDI Reclocked Outputs, (4) Outputs (GUI-selectable as SD-SDI and/or Analog CVBS), (4) Analog Audio Outputs (all coaxial connectors HD-BNC)

+3G Software license upgrade for 9501-DCDA-HD card. Upgrades card to 9501-DCDA-3G functionality/specifications.

+COLOR Color Correction Software Option

+FS Frame Sync Software Option

+DLY Extended Frame Sync Delay Option (add-on to option +FS; option +FS required)

+LTC Audio LTC Option