

# 9902-UDX-DSP-CI • 3G/HD/SD-SDI/CVBS Channel Integrator — UDX/Frame Sync with Video Optimization, Advanced Audio DSP Features, and SFP I/O Options



The Cobalt® 9902-UDX-DSP-CI Channel Integrator provides a comprehensive signal conversion and processing feature set designed to condition ingest Analog and Digital Audio and Video signals to meet comprehensive output requirements. The 9902-UDX-DSP-CI Channel Integrator provides a powerful, high-density 3G/HD/SD-SDI/CVBS Up/Down/Cross Converter-Frame Sync and Embedder/De-Embedder platform with support for the following optional features:

- Linear Frame Rate Standards Conversion Option
- RGB Color Correction Option
- Trouble Slate Insertion Option
- Logo Generator Option
- External SFP Cage Hardware Option
- HDMI, Fiber, IP ST2110, ST2022-6 SFP Options
- Emergency Alert Crawl Generator Option
- Text-To-Speech Generator Option
- Real-Time Loudness Leveling (RTLL) Loudness Processing Options
- Dolby® Encode/Decode Options
- Stereo to Surround Sound Upmixing Option

Along with the extensive list of features and options, the 9902-UDX-DSP-CI offers comprehensive high-quality standards conversion utilizing Cobalt's linear frame rate conversion to convert between virtually any SD/HD/3G format - 25/50, 29.97/30/59.94/60, and 23.98/24 (both film and PsF) from 525/625i to 1080p and anything in-between - with conversion to and from NTSC and PAL available for all input and output formats (see next page for full conversion matrix). This broad flexibility makes the 9902-UDX-DSP-CI perfect for international signal aggregators and distributors in the Cable, DBS, and OTT markets.

## I/O Capabilities

In addition to accepting and providing 3G/HD/SD-SDI I/O and CVBS I/O, the 9902-UDX-DSP-CI accommodates a wide array of baseband I/O, including:

- Externally-accessible SFP cage option allows flexible added I/O, including fiber, HDMI, and IP.
- Optionally accepts up to 12 channels of professional balanced analog audio embed/de-embed.
- Accepts up to 16 channels (8 pairs) of discrete unbalanced AES (AES-3id) embed/de-embed. Per-pair SRC can be applied to consumer (non-professional) digital audio sources to synchronize to 48 kHz video.
- Full audio crosspoint between embedded channels, balanced analog I/O and AES I/O.

As content delivery platforms evolve, conversion and processing systems need to be as comprehensive and cost effective as possible. Content providers/aggregators are tasked with receiving various signal types and standards and formatting them to the exact video, audio and metadata configuration needed on a per channel basis, and need an easy to deploy means of integrating and optimizing the components that comprise a modern broadcast. Designed to address these evolving needs in the densest foot print possible, the 9902-UDX-DSP-CI Channel Integrator provides the signal conversion and processing tool set needed to conform analog and digital audio and video signals and their associated metadata to meet sophisticated channel delivery requirements.

Flexibility and advanced video processing including broadcast quality Up/Down/Cross conversion with Noise Reduction and Detail Enhancement makes the 9902-UDX-DSP-CI perfect for rentals and international signal aggregators and distributors in all Lmarkets. The Channel Integrator is offered with a wide range of rear I/O options including high-density DIN and HDBNC and can be configured with a SFP I/O port option which adds support for either HDMI, fiber optic, or IP (SMPTE 2110 or SMPTE 2022-6).

## FEATURES

High-density openGear comprehensive signal integration solution

Optionally accepts SMPTE resolution and frame rate signals via HDMI allowing for computer and consumer A/V sources to be ingested

Frame Sync synchronizes to external reference and provides audio/video offsets as desired

Supports SNMP and Cobalt's Reflex (JSON) Protocols

Up/Down/Cross Conversion with user and AFD, VI, and WSS ARC specifically tailored for broadcast video

Noise Reduction and Detail Enhancement provide image quality optimization

Remote control/monitoring via Dashboard™ software or OGCP-9000 remote control panels

Five year warranty

## OPTIONS

**Note:** Options or ordering line items denoted as "-" are hardware-based options/items. These options are available as factory-installed only on new product, or product returned to Cobalt for factory installation.

Option -CI-SFP provides externally-accessible SFP cage allowing flexibly added I/O, including fiber I/O, and HDMI (See Ordering Information for SFP types available)

Option -CI-AN-AUD-EXPND expands analog audio I/O to provide 12 channels of analog audio embed/de-embed

Quality Check Option (+QC) provides failover, alert, or user presets action on criteria such as black/frozen frame, audio silence, and CC absence

Trouble Slate Option (+T-SLATE) allows uploading of up to three different user trouble slate graphic file to card, with automated insertion controlled by screened user-selectable events (such as LOS or frozen/black frame)

Logo Insertion Option (+LOGO) provides insertion for branding local or destination branding requirements

Linear Frame Rate Conversion Option (+FRC)

Clean & Quiet Switching Option (+CQS) - Provides automatic audio ramp-down and up during input switching events

Key/Fill Keyer Option (+KEYER)

Emergency Alert System Text Crawl Generation Option (+EAS)

Extended Frame Sync Delay Option (+LDLY)

Color Correction Option (+COLOR) provides full RGB color corrector (offset, gain, gamma) with extended YCbCr proc controls with white hard clip, white soft clip, black hard clip, and saturation clip

Audio LTC I/O Option (+LTC)

Text-To-Speech (+TTS) - Provides Text-To-Speech synthesis, directly converting EAS text to digital audio speech with no baseband signal breakouts or add-ons

Upmixing Option (+DSP-UPMIX-LA) provides high-quality Linear Acoustic® UPMAX™ 2.0-to-5.1 upmixing

Dolby Options (+DSP-ENC) and (+DSP-DEC) provide numerous Dolby encode and decode options (See Ordering Information for more info)

SCTE 104 Insertion (+SCTE104) - Provides generation/insertion of SCTE 104 data into baseband SDI. Message send can be triggered from automation GPI or other modes. Full control of splice start, end, and cancel as well as pre-roll offsets.

SCTE104 Frame-Accurate SCTE Trigger Insertion (+SCTE104-FAST) - Uses Time Stamp data derived from broadcast automation to provide deterministic, frame-accurate Digital Program Insertion (DPI) message embedding into SDI. The linear channel is output with precise metadata marking the beginning and ending of each program and commercial segment, optimizing it for automatic dissemination to CDN and VOD systems.

Loudness Processing Options (+DSP-RTLL) provide numerous Dolby Real-Time Loudness Leveling loudness processing options (See Ordering Information for more info)

**9902-UDX-DSP-CI • 3G/HD/SD-SDI/CVBS Channel Integrator — UDX/Frame Sync**  
with Video Optimization, Advanced Audio DSP Features, and SFP I/O Options

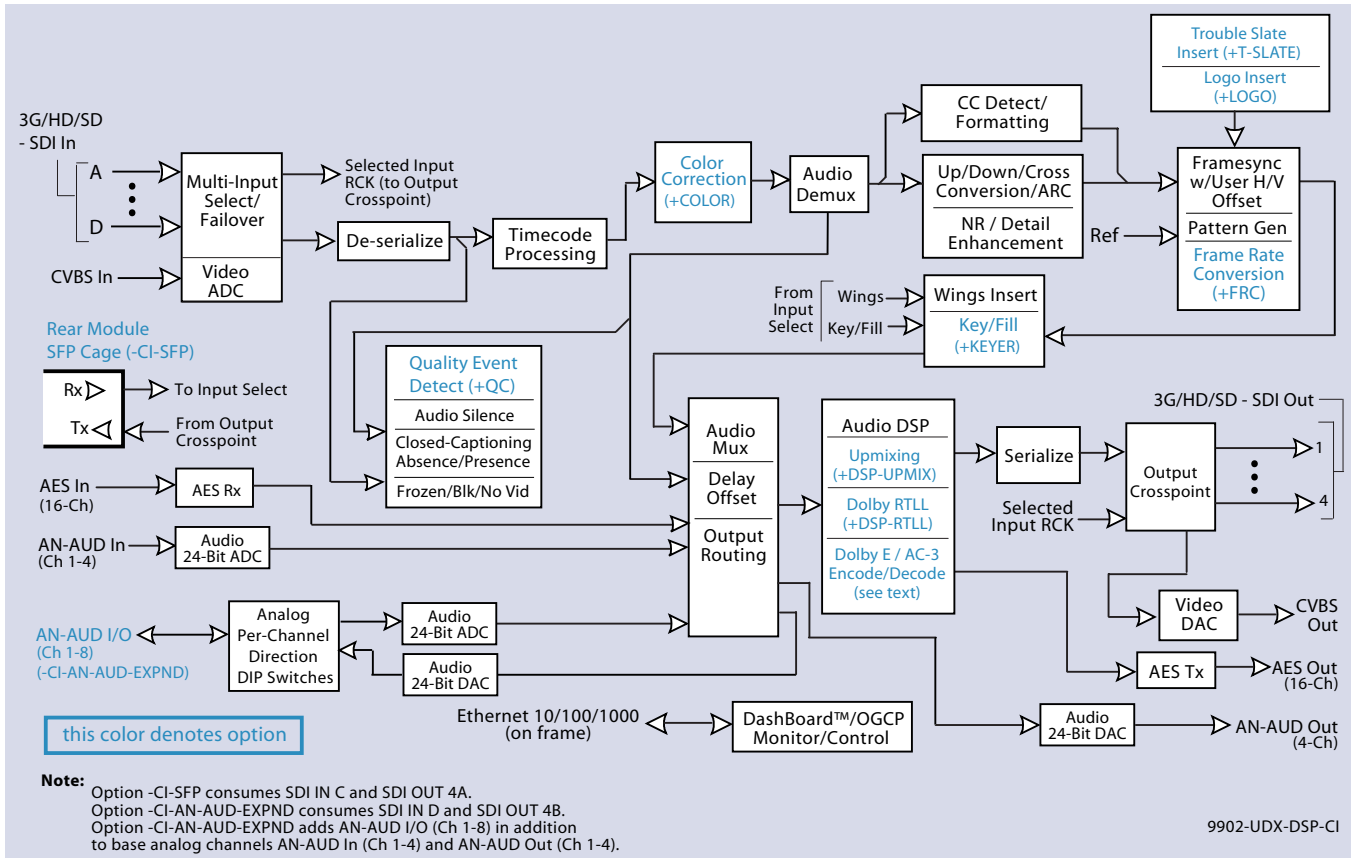

Inputs \ Outputs	525i 59.94	625i 50	720p 23.98	720p 24	720p 25	720p 29.97	720p 30	720p 50	720p 59.94	720p 60	1080i 50	1080i 59.94	1080i 60	1080PsF 23.98	1080PsF 24	1080PsF 25	1080PsF 29.97	1080PsF 30	1080PsF 23.98	1080p 24	1080p 25	1080p 29.97	1080p 30	1080p 50	1080p 59.94	1080p 60
525i 59.94	•	•	•	•	•	•	•	•	•	•	•	•	•	•	•	•	•	•	•	•	•	•	•	•	•	•
625i 50	•	•	•	•	•	•	•	•	•	•	•	•	•	•	•	•	•	•	•	•	•	•	•	•	•	•
720p 23.98	•	•	•	•	•	•	•	•	•	•	•	•	•	•	•	•	•	•	•	•	•	•	•	•	•	•
720p 24	•	•	•	•	•	•	•	•	•	•	•	•	•	•	•	•	•	•	•	•	•	•	•	•	•	•
720p 25	•	•	•	•	•	•	•	•	•	•	•	•	•	•	•	•	•	•	•	•	•	•	•	•	•	•
720p 29.97	•	•	•	•	•	•	•	•	•	•	•	•	•	•	•	•	•	•	•	•	•	•	•	•	•	•
720p 30	•	•	•	•	•	•	•	•	•	•	•	•	•	•	•	•	•	•	•	•	•	•	•	•	•	•
720p 50	•	•	•	•	•	•	•	•	•	•	•	•	•	•	•	•	•	•	•	•	•	•	•	•	•	•
720p 59.94	•	•	•	•	•	•	•	•	•	•	•	•	•	•	•	•	•	•	•	•	•	•	•	•	•	•
720p 60	•	•	•	•	•	•	•	•	•	•	•	•	•	•	•	•	•	•	•	•	•	•	•	•	•	•
1080i 50	•	•	•	•	•	•	•	•	•	•	•	•	•	•	•	•	•	•	•	•	•	•	•	•	•	•
1080i 59.94	•	•	•	•	•	•	•	•	•	•	•	•	•	•	•	•	•	•	•	•	•	•	•	•	•	•
1080i 60	•	•	•	•	•	•	•	•	•	•	•	•	•	•	•	•	•	•	•	•	•	•	•	•	•	•
1080PsF 23.98	•	•	•	•	•	•	•	•	•	•	•	•	•	•	•	•	•	•	•	•	•	•	•	•	•	•
1080PsF 24	•	•	•	•	•	•	•	•	•	•	•	•	•	•	•	•	•	•	•	•	•	•	•	•	•	•
1080PsF 25	•	•	•	•	•	•	•	•	•	•	•	•	•	•	•	•	•	•	•	•	•	•	•	•	•	•
1080PsF 29.97	•	•	•	•	•	•	•	•	•	•	•	•	•	•	•	•	•	•	•	•	•	•	•	•	•	•
1080PsF 30	•	•	•	•	•	•	•	•	•	•	•	•	•	•	•	•	•	•	•	•	•	•	•	•	•	•
1080p 23.98	•	•	•	•	•	•	•	•	•	•	•	•	•	•	•	•	•	•	•	•	•	•	•	•	•	•
1080p 24	•	•	•	•	•	•	•	•	•	•	•	•	•	•	•	•	•	•	•	•	•	•	•	•	•	•
1080p 25	•	•	•	•	•	•	•	•	•	•	•	•	•	•	•	•	•	•	•	•	•	•	•	•	•	•
1080p 29.97	•	•	•	•	•	•	•	•	•	•	•	•	•	•	•	•	•	•	•	•	•	•	•	•	•	•
1080p 30	•	•	•	•	•	•	•	•	•	•	•	•	•	•	•	•	•	•	•	•	•	•	•	•	•	•
1080p 50	•	•	•	•	•	•	•	•	•	•	•	•	•	•	•	•	•	•	•	•	•	•	•	•	•	•
1080p 59.94	•	•	•	•	•	•	•	•	•	•	•	•	•	•	•	•	•	•	•	•	•	•	•	•	•	•
1080p 60	•	•	•	•	•	•	•	•	•	•	•	•	•	•	•	•	•	•	•	•	•	•	•	•	•	•

Standards Conversion Table

**9902-UDX-DSP-CI • 3G/HD/SD-SDI/CVBS Channel Integrator — UDX/Frame Sync**  
with Video Optimization, Advanced Audio DSP Features, and SFP I/O Options

Externally-accessible SFP cage (Option +CI-SFP) on the card Rear Module allows flexible added I/O (including fiber, HDMI, and IP encap/de-encap) as well as repurposing by simply swapping SFP modules as desired

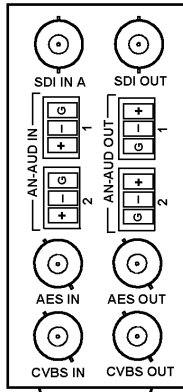
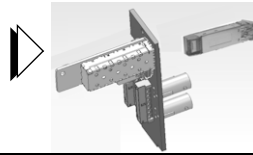

RM20-9902-UDX-DSP-CI-B

Note: RCK/PROC 1 thru RCK/PROC 4 are DA outputs which can be individually set as clocked or processed outputs of the currently-selected input.

RLY BYP B is a relay-protected path which carries processed SDI out under normal conditions and passive routes SDI IN B to this BNC upon loss of power.

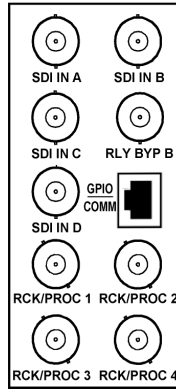

RM20-9902-UDX-DSP-CI-C

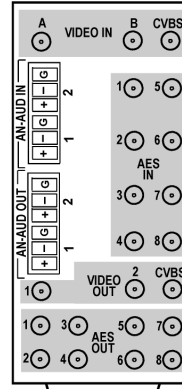

RM20-9902-UDX-DSP-CI-D (DIN / HD-BNC)

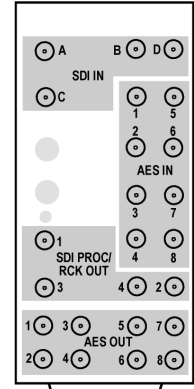

RM20-9902-UDX-DSP-CI-E (DIN / HD-BNC)

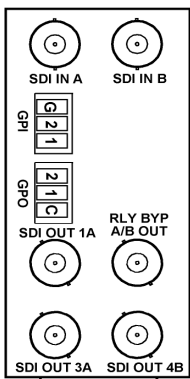

RM20-9902-UDX-DSP-CI-F

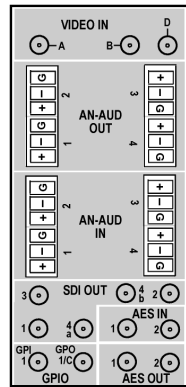

RM20-9902-UDX-DSP-CI-H (DIN / HD-BNC)

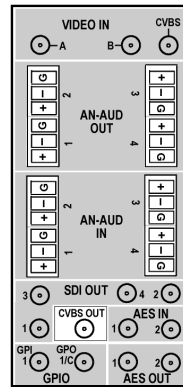

RM20-9902-UDX-DSP-CI-J (DIN / HD-BNC)

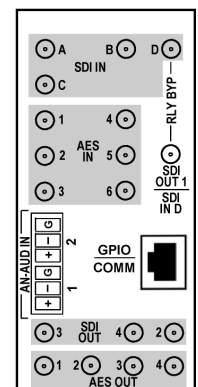

RM20-9902-UDX-DSP-CI-K (DIN / HD-BNC)

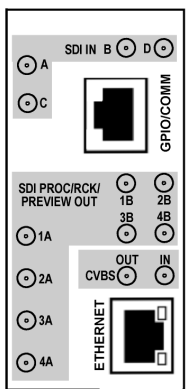

RM20-9902-UDX-DSP-CI-L (DIN / HD-BNC)

- 8 - GND
- 7 - COM\_A\_RX
- 6 - COM\_A\_TX
- 5 - GPO OUT 2
- 4 - GPO OUT 1
- 3 - GPO RTN
- 2 - GPI IN 2
- 1 - GPI IN 1

Note: A and B outputs are DA pairs of corresponding outputs 1 thru 4.

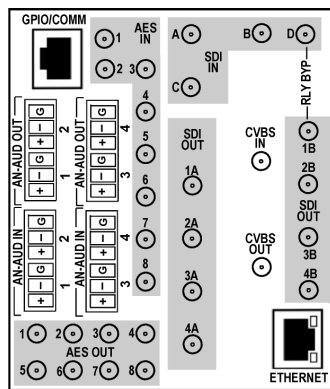

RM20-9902-UDX-DSP-CI-N (DIN / HD-BNC)

Note: AN-AUD I/O are an additional Ch 1-8 which are separate from base AN-AUD IN (1-4) and AN-AUD OUT (1-4). AN-AUD I/O (1-8) can be set as inputs or outputs using card DIP switches.

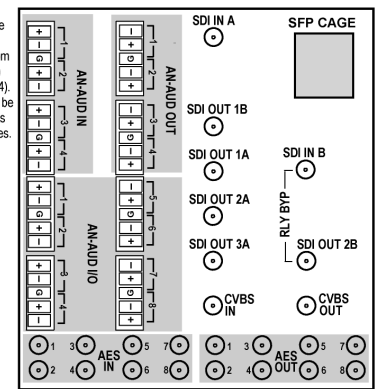

RM20-9902-UDX-DSP-CI-P (DIN / HD-BNC)

# 9902-UDX-DSP-CI • 3G/HD/SD-SDI/CVBS Channel Integrator — UDX/Frame Sync with Video Optimization, Advanced Audio DSP Features, and SFP I/O Options

## SPECIFICATIONS

### Power

24 Watts (including +DSP options)  
Add 6 Watts for option +AN-AUD-EXPND  
Add 3 Watts for option +SFP

### SDI Input/Outputs

(4) 75Ω inputs (max)  
(5) 75Ω outputs (max) (1 with relay bypass protect)  
SDI Formats Supported: SMPTE 259M, SMPTE 292M, SMPTE 424M  
SDI Receive Cable Length: 3G/HD/SD: 120/180/320 m (Belden 1694A)  
SDI Return Loss: >15 dB up to 1.485 GHz; >10 dB up to 2.970 GHz  
SDI Alignment Jitter: 3G/HD/SD: < 0.3/0.2/0.2 UI  
Timing Jitter 3G/HD/SD: <2.0/1.0/0.2 UI  
Minimum Latency (scaler and frame sync disabled):  
SD: 127 pixels; 9.4 us  
720p: 330 pixels; 4.45 us  
1080i: 271 pixels; 3.65 us  
1080p: 361 pixels; 2.43 us

### CVBS Video Input/Outputs

(1) 75Ω BNC input  
(1) 75Ω BNC output. CVBS can be upconverted to any supported SDI format; all inputs can be downconverted to CVBS.  
CVBS ADC resolution: 10-bit  
CVBS ADC sampling: 4x over-sampling  
CVBS DAC resolution: 10-bit  
CVBS DAC sampling: 16x over-sampling  
Y/C separation: 4-line Adaptive Comb Filter  
Freq. Response: ± 0.25 dB to 5.5 MHz  
SNR: > 50 dB to 5.5 MHz (unweighted)  
Differential Phase: < 1 degree  
Differential Gain: < 1%  
Nonlinearity < 1%

### Discrete Audio Input/Outputs

AES-3id 75Ω inputs (8 pair (16-Ch) max)  
AES-3id 75Ω outputs (8 pair (16-Ch) max)  
Input AES SRC Range: 32 to 96 kHz  
Balanced analog audio inputs (4-Ch max; 12-Ch max w/ option +AN-AUD-EXPND)  
Balanced analog audio outputs (4-Ch max; 12-Ch max w/ option +AN-AUD-EXPND)

### Frame Sync Audio/Video Delay

Max offset: 20 frames  
Latency (min): 1 frame  
Option +DLY Delay (3G/HD/SD): >800 msec / >1580 msec / >9000 msec

### ARC

ARC manually configurable (custom) or automatic triggering in full compliance/conformity with AFD (SMPTE 2016), VI (RP186), and WSS triggering.

### User Audio Delay Offset from Video

Bulk delay control: -33 msec to +3000 msec.  
Per-channel delay controls: -800 msec to +800 msec

### Audio Conversion Format

48 kHz sampling, 24-bit. Auto-SRC bypass for Dolby inputs. Analog audio I/O conforms to +24 dBu <=> 0 dBFS.

**Note:** Fiber specifications are typical, and only applicable for card fitted with optional Tx or Rx (as applicable) fiber SFP module. Specifications subject to change.

### Fiber Transmit Output (typ. with fiber Tx SFP)

LC connector  
Fiber Wavelength, Tx: 1310 nm  
Tx Power: -5.0 dBm (min)

### Fiber Receive Input (typ. with fiber Rx SFP)

LC connector  
Receive Sensitivity: -23 dBm; 1260 to 1620 nm (with internal power meter status display)

### HDMI Input (typ. with HDMI-to-SDI HDMI SFP)

(1) HDMI 1.4 Input; type D-micro connector; DVI-D compliant input (limited to SMPTE HD formats).

# 9902-UDX-DSP-CI • 3G/HD/SD-SDI/CVBS Channel Integrator — UDX/Frame Sync with Video Optimization, Advanced Audio DSP Features, and SFP I/O Options

## SPECIFICATIONS (cont.)

### HDMI Output (typ. with SDI-to-HDMI SFP)

(1) HDMI 1.4 Output; type D-micro connector; DVI-D compliant input (limited to SMPTE HD formats).

### Analog Audio Specifications

4-ch inputs; 4-ch outputs (base). 8-ch I/O additional (12-ch total) with option +CI-AN-AUD-EXPND.

Input Impedance: > 10kΩ

Reference Level: -20 dBFS

Nominal Level: +4 dBu

Input Clip Level: +24 dBu (0 dBFS)

Freq. Response: ±0.2 dB (20 Hz to 20 kHz)

SNR: 115 dB (A weighted)

THD+N: -96 dB (20 Hz to 10 kHz)

Crosstalk: -106 dB (20 Hz to 20 kHz)

Output Impedance: < 50Ω

Max. Output Level: +24 dBu (0 dBFS)

(I/O conforms to 0 dBFS = +24 dBu)

### Frame Reference Input

(2) reference from frame bus. SMPTE 170M/318M "Black Burst", SMPTE 274M/296M "Tri-Level".

## ORDERING INFORMATION

**9902-UDX-DSP-CI** 3G/HD/SD-SDI/CVBS Channel Integrator – UDX/Frame Sync and Embedder/De-Embedder with Video Optimization, Advanced Audio DSP Features, and SFP I/O Options

### Options:

**Note:** Options denoted as "+" are software-based options which are available on new product when ordered or can be customer field-installed as a software upload upgrade. Options or ordering line items denoted as "-" are hardware orderable items (such as SFP and expansion modules). These options are available as factory-installed only on new product, or product returned to Cobalt for factory installation.

+COLOR Color Correction Option

+QC Quality Check Option

+FRC Linear Frame Rate Conversion Option

+LTC Audio LTC I/O Option

+DLY Extended Frame Sync Delay Option

+SCTE104 SCTE 104 Insertion Option

+SCTE104-FAST Frame-Accurate SCTE 104 Trigger Insertion Option

+T-SLATE User Trouble Slate Graphic Import Option

+LOGO Logo Insertion Option

+KEYER Key/Fill Keyer Option

+TTS Text-To-Speech Option (Acapela Text-To-Speech from Acapela Group™. Installation requires option upload and installation of speech library SD memory card onto host card. Pre-loaded SD card and instructions provided.)

+2L-SPAN Add Spanish-language upgrade (add-on to option +TTS; option +TTS required)

+EAS Emergency Alert System Text Crawl Generation Option

+CQS Clean & Quiet Switching Option

+DSP-RTLL-5.1 Dolby® Real-Time Loudness Leveling 5.1-Channel Surround Sound Loudness Processor

+DSP-RTLL-2.0 Dolby® Real-Time Loudness Leveling 2.0-Channel Stereo Loudness Processor

+DSP-ENCD-5.1 Dolby® Digital / Digital Plus 5.1 Encoder

+DSP-ENCD-2.0 Dolby® Digital / Digital Plus 2.0 Encoder

+DSP-DEC Dolby® E / Dolby® Digital / Dolby® Digital Plus Decoder

+DSP-UPMIX-LA Linear Acoustic UPMAX™ 2.0-to-5.1 Upmixer

# 9902-UDX-DSP-CI • 3G/HD/SD-SDI/CVBS Channel Integrator — UDX/Frame Sync with Video Optimization, Advanced Audio DSP Features, and SFP I/O Options

## ORDERING INFORMATION (cont.)

**-CI-SFP** Adds daughter card supporting externally-accessible SFP cage; orderable as new option or field upgrade.

**Note:** To support SFP option(s), this option is required in addition to desired specific SFP options below. Option can only be used with rear module RM20-9902-UDX-DSP-CI-P-DIN or RM20-9902-UDX-DSP-CI-P-HDBNC.

**-CI-AN-AUD-EXPND** Adds daughter card supporting additional 8-Ch balanced analog audio I/O. Channel I/O direction user-configurable using card per-channel DIP switches. Orderable as new option or field upgrade.

**Note:** To support this option, this option requires rear module RM20-9902-UDX-DSP-CI-P-DIN or RM20-9902-UDX-DSP-CI-P-HDBNC.

**-SFP-EO** 3G/HD/SD-SDI/ASI/MADI Video SFP Optical, Single Transmitter, Medium Haul, 1310nm

**-SFP-OE** 3G/HD/SD-SDI/ASI/MADI Video SFP Optical, Single Receiver, Medium Haul

**-SFP-EOOE** 3G/HD/SD-SDI/ASI/MADI Video SFP Optical, Transceiver, Medium Haul, 1310nm

**-SFP-EO-CWDM-WX** 3G/HD/SD-SDI/ASI/MADI Video SFP Optical, Single Transmitter, Long Haul. Specify CWDM Wavelength in place of -WX (see table below)

**-SFP-EOOE-CWDM-WX** 3G/HD/SD-SDI/ASI/MADI Video SFP Optical, Transceiver, Long Haul. Specify CWDM Wavelength in place of -WX (see table below)

In "WX" places in part number, substitute code for wavelengths in each place as listed below:

-27: 1270nm -29: 1290nm -31: 1310nm  
 -33: 1330nm -35: 1350nm -37: 1370nm  
 -39: 1390nm -41: 1410nm -43: 1430nm  
 -45: 1450nm -47: 1470nm -49: 1490nm  
 -51: 1510nm -53: 1530nm -55: 1550nm  
 -57: 1570nm -59: 1590nm -61: 1610nm

(Example: SFP-EO-CWDM-27 has 1270 nm FIBER OUT CWDM wavelength)

**-SFP-H-TO-S** HDMI/DVI To SDI Video SFP Converter, Single Receiver, Type D with retention clip  
**(Note: The H-to-S SFP module used here supports 8-bit input only.)**

**-SFP-S-TO-H** SDI To HDMI/DVI Video SFP Converter, Single Transmitter, Type D with retention clip

**-SFP-IP-SWD** Software-Defined EmSFP 2110 or 2022-6 Encap/De-Encap 10GigE Multi-Mode Optical Interface with Female LC Duplex Connectors. The following I/O purposing software options are available for cards using SFP type **-SPF-IP-SWD**:

**+ADD-SFP-2SDI-TO-IP-2022-6** SFP Software License; Dual-Channel Encapsulator 2SDI-to-IP-2022-6

**+ADD-SFP-2SDI-TO-IP-2110** SFP Software License; Dual-Channel Encapsulator 2SDI-to-IP-2110

**+ADD-SFP-IP-TO-2SDI-2022-6** SFP Software License; Dual-Channel De-Encapsulator IP-2022-6-to-2SDI

**+ADD-SFP-IP-TO-2SDI-2110** SFP Software License; Dual-Channel De-Encapsulator IP-2110-to-2SDI

**+ADD-SFP-IP-TO-SDI-2022-6** SFP Software License; Single-Channel De-Encapsulator IP-2022-6-to-SDI

**+ADD-SFP-IP-TO-SDI-2110** SFP Software License; Single-Channel De-Encapsulator IP-2110-to-SDI

**+ADD-SFP-SDI-TO-IP-2022-6** SFP Software License; Single-Channel Encapsulator SDI-to-IP-2022-6

**+ADD-SFP-SDI-TO-IP-2110** SFP Software License; Single-Channel Encapsulator SDI-to-IP-2110

## Rear I/O Modules:

**RM20-9902-UDX-DSP-CI-B** 20-Slot Frame Rear I/O Module (Standard-Width) (1) 3G/HD/SD-SDI Input BNC, (1) CVBS Input BNC, (2) Balanced Analog Audio Inputs, (1) AES Input BNC, (1) 3G/HD/SD-SDI Output BNC, (1) CVBS Processed Out BNC, (2) Balanced Analog Audio Outputs, (1) AES Output BNC

**RM20-9902-UDX-DSP-CI-C** 20-Slot Frame Rear I/O Module (Standard Width) (4) 3G/HD/SD-SDI Input BNCs, (4) 3G/HD/SD-SDI Output BNCs, (1) 3G/HD/SDI Output BNC (with relay bypass failover), GPIO/COMM RJ-45 connector

**RM20-9902-UDX-DSP-CI-D-DIN** 20-Slot Frame Rear I/O Module (Standard Width) (2) 3G/HD/SD-SDI Inputs, (1) CVBS Input, (8) AES Inputs, (2) Balanced Analog Audio Inputs, (2) 3G/HD/SD-SDI Outputs, (1) CVBS Processed Output, (8) AES Outputs, (2) Balanced Analog Audio Outputs (All coaxial connectors DIN1.0/2.3.)

**RM20-9902-UDX-DSP-CI-D-HDBNC** 20-Slot Frame Rear I/O Module (Standard Width) (2) 3G/HD/SD-SDI Inputs, (1) CVBS Input, (8) AES Inputs, (2) Balanced Analog Audio Inputs, (2) 3G/HD/SD-SDI Outputs, (1) CVBS Processed Output, (8) AES Outputs, (2) Balanced Analog Audio Outputs (All coaxial connectors HD-BNC.)

**RM20-9902-UDX-DSP-CI-E-DIN** 20-Slot Frame Rear I/O Module (Standard Width) (4) 3G/HD/SD-SDI Inputs, (8) AES Inputs, (4) 3G/HD/SD-SDI Outputs, (8) AES Outputs (All coaxial connectors DIN1.0/2.3.)

**RM20-9902-UDX-DSP-CI-E-HDBNC** 20-Slot Frame Rear I/O Module (Standard Width) (4) 3G/HD/SD-SDI Inputs, (8) AES Inputs, (4) 3G/HD/SD-SDI Outputs, (8) AES Outputs (All coaxial connectors HD-BNC.)

## 9902-UDX-DSP-CI • 3G/HD/SD-SDI/CVBS Channel Integrator — UDX/Frame Sync with Video Optimization, Advanced Audio DSP Features, and SFP I/O Options

### ORDERING INFORMATION (cont.)

**RM20-9902-UDX-DSP-CI-F** 20-Slot Frame Rear I/O Module (Standard Width) (2) 3G/HD/SD-SDI Input BNCs, (1) 3G/HD/SD-SDI Processed Out BNC w/ Latching Input Select/Bypass, (3) 3G/HD/SD-SDI Output BNCs (GUI-selectable as processed or relocked of selected input), (2) GPI, (2) GPO

**RM20-9902-UDX-DSP-CI-H-DIN** 20-Slot Frame Rear I/O Module (Standard Width) (3) 3G/HD/SD-SDI Inputs (2) AES Inputs, (4) Balanced Analog Audio Inputs, (5) 3G/HD/SD-SDI Outputs, (2) AES Outputs, (4) Balanced Analog Audio Outputs, (1) Coaxial GPI/6 Hz, (1) Coaxial GPO w/ Isolated Return (All coaxial connectors DIN1.0/2.3.)

**RM20-9902-UDX-DSP-CI-H-HDBNC** 20-Slot Frame Rear I/O Module (Standard Width) (3) 3G/HD/SD-SDI Inputs, (2) AES Inputs, (4) Balanced Analog Audio Inputs, (5) 3G/HD/SD-SDI Outputs, (2) AES Outputs, (4) Balanced Analog Audio Outputs, (1) Coaxial GPI/6 Hz, (1) Coaxial GPO w/ Isolated Return (All coaxial connectors HD-BNC.)

**RM20-9902-UDX-DSP-CI-J-DIN** 20-Slot Frame Rear I/O Module (Standard Width) (2) 3G/HD/SD-SDI Inputs, (1) CVBS Input, (2) AES Inputs, (4) Balanced Analog Audio Inputs, (4) 3G/HD/SD-SDI Outputs, (1) CVBS Output, (2) AES Outputs, (4) Balanced Analog Audio Outputs, (1) Coaxial GPI/6 Hz, (1) Coaxial GPO w/ Isolated Return (All coaxial connectors DIN1.0/2.3.)

**RM20-9902-UDX-DSP-CI-J-HDBNC** 20-Slot Frame Rear I/O Module (Standard Width) (2) 3G/HD/SD-SDI Inputs, (1) CVBS Input, (2) AES Inputs, (4) Balanced Analog Audio Inputs, (4) 3G/HD/SD-SDI Outputs, (1) CVBS Output, (2) AES Outputs, (4) Balanced Analog Audio Outputs, (1) Coaxial GPI/6 Hz, (1) Coaxial GPO w/ Isolated Return (All coaxial connectors HD-BNC.)

**RM20-9902-UDX-DSP-CI-K-DIN** 20-Slot Frame Rear I/O Module (Standard Width) (4) 3G/HD/SD-SDI Inputs, (4) 3G/HD/SD-SDI Outputs (one 3G/HD/SDI Output with relay bypass failover), (6) AES Inputs, (2) Balanced Analog Audio Inputs, (4) AES Outputs, GPIO/COMM RJ-45 connector (All coaxial connectors DIN1.0/2.3)

**RM20-9902-UDX-DSP-CI-K-HDBNC** 20-Slot Frame Rear I/O Module (Standard Width) (4) 3G/HD/SD-SDI Inputs, (4) 3G/HD/SD-SDI Outputs (one 3G/HD/SDI Output with relay bypass failover), (6) AES Inputs, (2) Balanced Analog Audio Inputs, (4) AES Outputs, GPIO/COMM RJ-45 connector (All coaxial connectors HD-BNC)

**RM20-9902-UDX-DSP-CI-L-DIN** 20-Slot Frame Rear I/O Module (Standard-Width) (4) 3G/HD-SD-SDI Inputs, (1) CVBS Input, (8) 3G/HD/SD-SDI Outputs (1x2 DA output of each crosspoint out), (1) CVBS Output, COMM/GPIO RJ-45 connector, Ethernet Port (All coaxial connectors DIN1.0/2.3)

**RM20-9902-UDX-DSP-CI-L-HDBNC** 20-Slot Frame Rear I/O Module (Standard-Width) (4) 3G/HD-SD-SDI Inputs, (1) CVBS Input, (8) 3G/HD/SD-SDI Outputs (1x2 DA output of each crosspoint out), (1) CVBS Output, COMM/GPIO RJ-45 connector, Ethernet Port (All coaxial connectors HD-BNC)

**RM20-9902-UDX-DSP-CI-N-DIN** 20-Slot Frame Rear I/O Module (Double Width) (4) 3G/HD/SD-SDI Inputs, (1) CVBS Analog Video In, (8) AES Inputs, (4) Balanced Analog Audio Inputs, (8) 3G/HD/SD-SDI Outputs (1 with relay bypass protect), (1) CVBS Analog Video Out, (8) AES Outputs, (4) Balanced Analog Audio Outputs, (1) GPIO/COMM RJ-45 connector, 100/1000 BaseT Ethernet Port (All coaxial connectors DIN1.0/2.3.)

**RM20-9902-UDX-DSP-CI-N-HDBNC** 20-Slot Frame Rear I/O Module (Double Width) (4) 3G/HD/SD-SDI Inputs, (1) CVBS Analog Video In, (8) AES Inputs, (4) Balanced Analog Audio Inputs, (8) 3G/HD/SD-SDI Outputs (1 with relay bypass protect), (1) CVBS Analog Video Out, (8) AES Outputs, (4) Balanced Analog Audio Outputs, (1) GPIO/COMM RJ-45 connector, 100/1000 BaseT Ethernet Port (All coaxial connectors HD-BNC.)

**Note:** Rear module RM20-9902-UDX-DSP-CI-P-DIN or RM20-9902-UDX-DSP-CI-P-HDBNC is required if option +CI-SFP and/or +CI-AN-AUD-EXPND is ordered.

**RM20-9902-UDX-DSP-CI-P-DIN** 20-Slot Frame Rear I/O Module (Double-Width) (2) 3G/HD/SD-SDI Inputs, (1) CVBS Input, (4) Balanced Analog Audio Inputs, (8) AES-3id AES Inputs, (1) SFP cage receptacle (valid with option +CI-SFP), (5) 3G/HD/SD-SDI Outputs (relay bypass for SDI IN B - SDI OUT 2B path), (1) CVBS Output, (4) Balanced Analog Audio Outputs, (8) AES-3id AES Outputs, (8) Balanced Analog Audio I/O additional channels (valid with option +CI-AN-AUD-EXPND). (All coaxial connectors DIN1.0/2.3.)

**RM20-9902-UDX-DSP-CI-P-HDBNC** 20-Slot Frame Rear I/O Module (Double-Width) (2) 3G/HD/SD-SDI Inputs, (1) CVBS Input, (4) Balanced Analog Audio Inputs, (8) AES-3id AES Inputs, (1) SFP cage receptacle (valid with option +CI-SFP), (5) 3G/HD/SD-SDI Outputs (relay bypass for SDI IN B - SDI OUT 2B path), (1) CVBS Output, (4) Balanced Analog Audio Outputs, (8) AES-3id AES Outputs, (8) Balanced Analog Audio I/O additional channels (valid with option +CI-AN-AUD-EXPND). (All coaxial connectors HD-BNC.)

