

9902-UDX-FS • 3G/HD/SD-SDI Dual-Channel – Path 1 UDX / Path 2 Frame Sync with Audio Embed/De-Embed

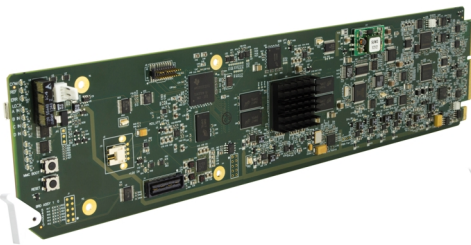

The Cobalt® 9902-UDX-FS 3G/HD/SD-SDI Dual-Channel – Path 1 UDX / Path 2 Frame Sync with Audio Embed/De-Embed offers **two independent signal paths**: one path of full up/down/cross conversion, frame sync, and audio embedding /de-embedding, and the other path economically offering frame sync and audio embedding / de-embedding – all in a single openGear® card. Using our HPF-9000 20-slot frame, this provides up to 40 channels of processing in a single frame. The 9902-UDX-FS is another new Cobalt model representing a new level of openGear packaging density!

The 9902-UDX-FS provides high-density that offers unprecedented multi-input support and flexibility. The up/down/cross convert scaler is specifically designed for broadcast video formats, with full ARC control suitable for conversions to or from 4:3 and 16:9 aspect ratios. AFD processing can detect an incoming AFD code and correspondingly set scaling and ARC to track with AFD. This processor also allows independent custom ARC to be applied for each incoming AFD code, and set the desired AFD code to be inserted on the output, even if there is no code detected on

the input. Analog video (CVBS) input, with AES and analog audio embedding and de-embedding is also supported and can work with either of the card's two processing channels.

Audio embed adaptive SRC allows asynchronous 48 kHz AES audio to automatically sync with program video 48 kHz timing for glitch-free embedding. Individual, per-pair SRC auto-detects and disables SRC when a Dolby pair is detected on an input pair. Bulk and per-channel audio delay controls easily address lip-sync issues. Quality Check option +QC allows failover to alternate inputs based on user-configurable criteria such as black/frozen frame. Included standard is closed captioning absence/presence detection that allows CEA 608/708 and line 21 SD CC absence or presence to be detected, with event actions consisting of GPIO, automated alert email actions, or go-to card user presets or other actions.

A convenient input crosspoint can select from up to four SDI inputs to be applied to either of the unit's two processing paths. The input crosspoint allows manual or failover to alternate inputs on loss of input conditions. Option +TTS provides high-quality Text-To-Speech synthesis, directly converting EAS text to digital audio speech with no baseband signal breakouts or add-ons. With option +ANC, the 9902-UDX-FS offers full VANC/HANC ancillary data packet de-embedding and embedding.

Preset save/load allows saving custom settings while allowing one-button revert to factory settings. Layered presets allow invoking changes related only to a specific area of concern (audio routing, for example) while not changing any other processing settings or aspects. Full user Dashboard™ or Remote Control Panel remote control allows full status and control access locally or across a standard Ethernet network. GPIO allows direct input routing control and status monitoring.

FEATURES

Multi-input RP168 clean switch, with manual selection or GPI controlled input selection. Path inputs can also be sourced from opposite path output with no external patching.

Auto-Changeover can be set to invoke failover for basic input loss. Quality Check option (+QC) provides alert actions on criteria such as black/frozen frame, audio silence, and closed-captioning absence. Threshold and hold-off are user configurable.

Up/Down/Cross Conversion (Path 1) with user and AFD, VI, and WSS ARC specifically tailored for broadcast video

Frame sync with full H/V offset and manual/LOS video pattern generator. Pattern generator for each channel can provide raster/test pattern and patterns for LOS failover

Timecode processing can prioritize, filter for, and convert between specific SMPTE embedded-video or audio LTC

Advanced audio processing allows routing, gain, delay, and flexible mixing as standard features

Full audio crosspoint with delay control and 5.1-to-stereo downmix available for all audio outputs

Video options include color correction

Upgrade option +UDX-FS-to-2UDX converts path 2 to full UDX/Frame Sync

CVBS analog video input and analog/AES embed / de-embed with 4-line Adaptive Comb Filter

Pattern generator for each channel can provide raster/test pattern and patterns for LOS failover insertion

Low-power/high-density design – less than 18 Watts per card

Remote control/monitoring via Dashboard™ software or OGCP-9000 Remote Control Panel

Five year warranty

OPTIONS

Quality Check (+QC) – Provides failover, alert, or user presets action on criteria such as black/frozen frame, audio silence, and CC absence.

Color Correction (+COLOR) – Full RGB color corrector (offset, gain, gamma) with extended YCbCr proc controls with white/black hard clip, white soft clip, and saturation clip

Ancillary Data Processor (+ANC) – Provides full user VANC/HANC packet insertion/extraction access to DID/SDID ancillary data

Text-To-Speech (+TTS) – Provides Text-To-Speech synthesis, directly converting EAS text to digital audio speech with no baseband signal breakouts or add-ons. High-quality Text-To-Speech from Acapela Group.

Clean & Quiet Switching Option (+CQS) – Provides automatic audio ramp-down and up during input switching events

Add Path 2 UDX (+UDX-FS-to-2UDX) – Converts path 2 to full UDX/Frame Sync

Expanded Delay (+DLY) – Increases frame buffer to provide adjustable audio/video delay buffer capacity to over 9 seconds for SD video, 1.5 seconds for HD video, or 0.8 seconds for 3G video.

SCTE 104 Insertion (+SCTE104) – Provides generation/insertion of SCTE 104 data into baseband SDI. Message send can be triggered from automation GPI or other modes. Full control of splice start, end, and cancel as well as pre-roll offsets.

SCTE104 Frame-Accurate SCTE Trigger Insertion (+SCTE104-FAST) – Uses Time Stamp data derived from broadcast automation to provide deterministic, frame-accurate Digital Program Insertion (DPI) message embedding into SDI. The linear channel is output with precise metadata marking the beginning and ending of each program and commercial segment, optimizing it for automatic dissemination to CDN and VOD systems.

Audio LTC I/O (+LTC)



9902-UDX-FS • 3G/HD/SD-SDI Dual-Channel – Path 1 UDX / Path 2 Frame Sync with Audio Embed/De-Embed

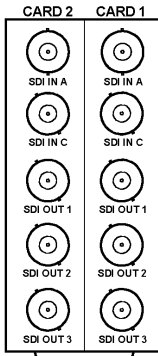
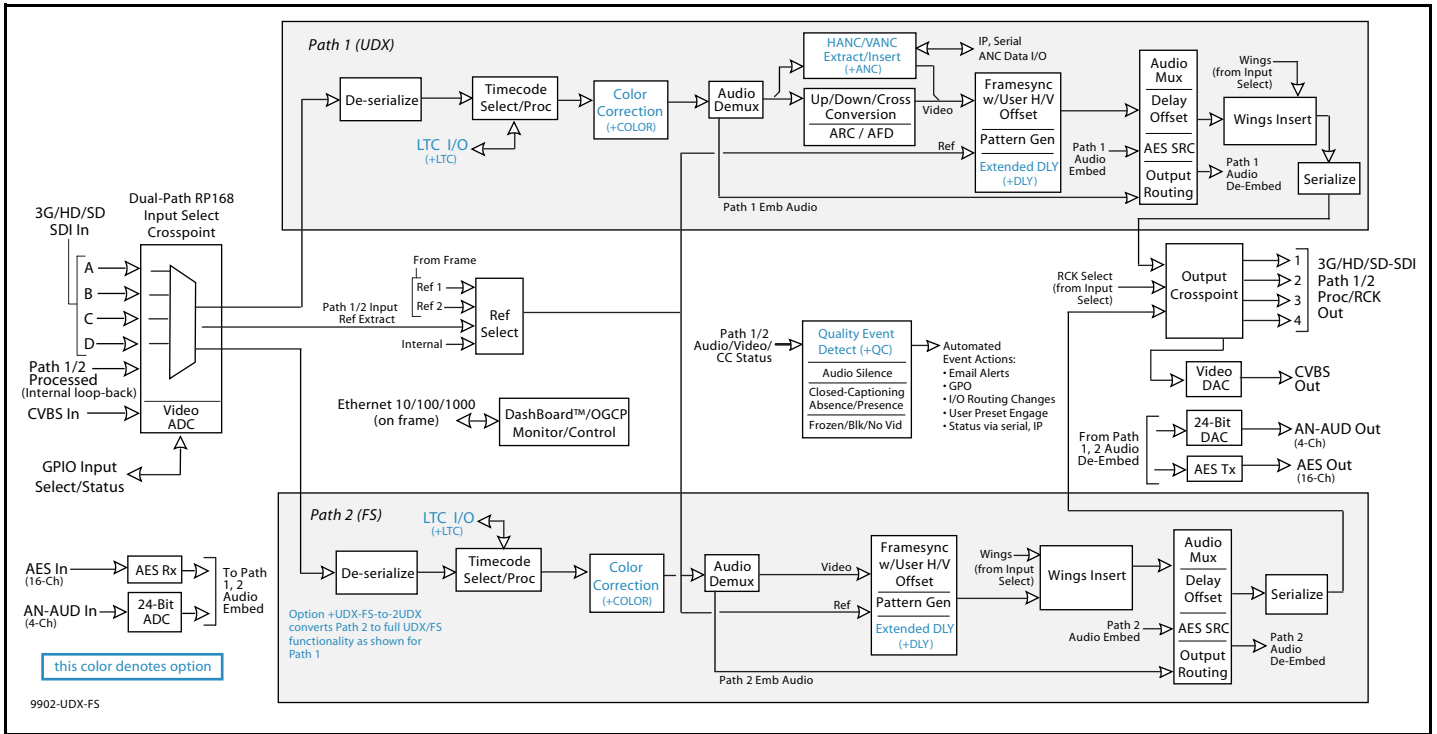

RM20-9902-UDX-FS-A

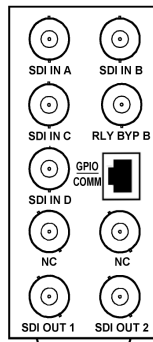

RM20-9902-UDX-FS-C

Note: RLY BYP B is a relay-protected path which carries processed SDI out under normal conditions and passive routes SDI IN B to this BNC upon loss of power.

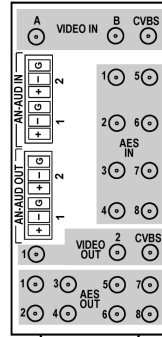

RM20-9902-UDX-FS-D (DIN | HDBNC)

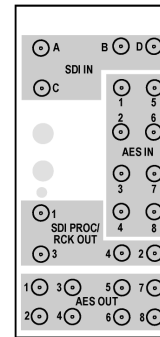

RM20-9902-UDX-FS-E (DIN HDBNC)

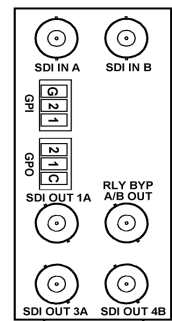

RM20-9902-UDX-FS-F

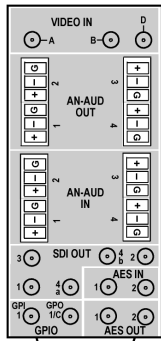

RM20-9902-UDX-FS-H (DIN | HDBNC)

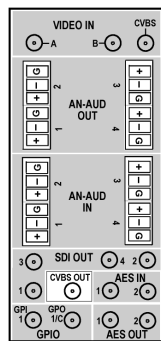

RM20-9902-UDX-FS-J (DIN | HDBNC)

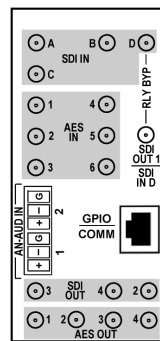

RM20-9902-UDX-FS-K (DIN | HDBNC)

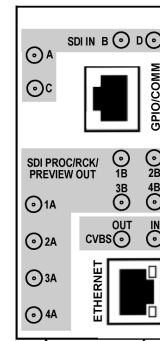

RM20-9902-UDX-FS-L (DIN | HDBNC)

8 - GND
7 - COM_A_RX
6 - COM_A_TX
5 - GPO OUT 2
4 - GPO OUT 1
3 - GPO RTN
2 - GPI IN 2
1 - GPI IN 1

Note: A and B outputs are DA pairs of corresponding outputs 1 thru 4.

9902-UDX-FS • 3G/HD/SD-SDI Dual-Channel – Path 1 UDX / Path 2 Frame Sync with Audio Embed/De-Embed

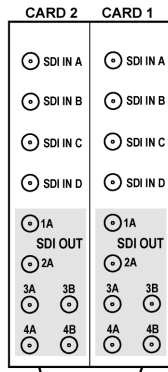

RM20-9902-UDX-FS-MIS
(DIN | HDBNC)

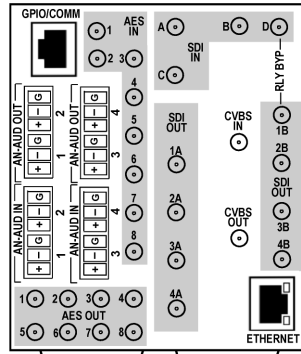

RM20-9902-UDX-FS-N
(DIN | HDBNC)

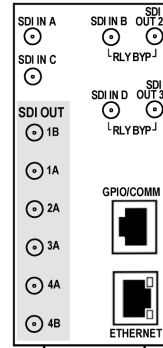

RM20-9902-UDX-FS-P
(DIN | HDBNC)

- 8 - GND
 - 7 - COM_A_RX
 - 6 - COM_A_TX
 - 5 - GPO OUT 2
 - 4 - GPO OUT 1
 - 3 - GPO RTN
 - 2 - GPI IN 2
 - 1 - GPI IN 1
- Note: A and B outputs are DA pairs of corresponding outputs 1 thru 4.

SPECIFICATIONS

Note: Inputs/outputs are a function in some cases of rear I/O module used.

Power

< 18 Watts

SDI Input/Outputs

Up to (4) 75Ω BNC inputs
 Up to (4) 75Ω BNC outputs (selectable as processed SDI Path 1 or Path 2, or selected input reclocked)
 SDI Formats Supported: SMPTE 259M, SMPTE 292M, SMPTE 424M
 SDI Receive Cable Length: 3G/HD/SD: 120/180/320 m (Belden 1694A)
 SDI Return Loss: >15 dB up to 1.485 GHz; >10 dB up to 2.970 GHz
 SDI Alignment Jitter: 3G/HD/SD: < 0.3/0.2/0.2 UI
 Timing Jitter: 3G/HD/SD: < 2.0/1.0/0.2 UI
 Minimum Latency (scaler and frame sync disabled): SD: 127 pixels (9.4 us); 720p: 330 pixels (4.45 us); 1080i: 271 pixels (3.65 us); 1080p: 361 pixels (2.43 us)
 Note: SDI Return loss and receive cable length are affected by rear I/O module used. Specifications represent typical performance.

CVBS Video Input/Outputs

(1) 75Ω BNC input
 (1) 75Ω BNC output (selectable as Path 1 or Path 2 processed output). CVBS output functional only when selected path is carrying SD-SDI.
 ADC resolution: 9-bit
 Sampling frequency: 27 MHz (2x over-sampling)
 Y/C separation: 4 line Adaptive Comb Filter
 Freq. Response: ± 0.25 dB to 5.5 MHz
 SNR: > 50 dB to 5.5 MHz (unweighted)
 Differential Phase: < 1 degree
 Differential Gain: < 1%
 Nonlinearity < 1%

Discrete Audio Input/Outputs

AES-3id 75Ω inputs (8 pair (16-Ch) max)
 AES-3id 75Ω outputs (8 pair (16-Ch) max)
 Input AES SRC Range: 32 to 96 kHz
 Balanced analog audio inputs (4-Ch max)
 Balanced analog audio outputs (4-Ch max)
 (I/O conforms to 0 dBFS = +24 dBu)
 Analog Output Impedance: < 50 Ω
 Analog Reference Level: -20 dBFS
 Analog Nominal Level: +4 dBu
 Analog Max Output Level: +24 dBu (0 dBFS)
 Analog Freq. Response: ±0.2 dB (20 Hz to 20 kHz)
 Analog SNR: 115 dB (A weighted)
 Analog THD+N: -96 dB (20 Hz to 10 kHz)
 Analog Crosstalk: -106 dB (20 Hz to 20 kHz)

9902-UDX-FS • 3G/HD/SD-SDI Dual-Channel – Path 1 UDX / Path 2 Frame Sync with Audio Embed/De-Embed

SPECIFICATIONS (cont.)

Frame Sync Audio/Video Delay

Max offset: 20 frames
 Latency (min): 1 frame
 Option +DLY Delay (3G/HD/SD): >800 msec / >1580 msec / >9000 msec

User Audio Delay Offset from Video

Bulk delay control: -33 msec to +3000 msec.
 Per-channel delay controls: -800 msec to +800 msec

ARC

ARC manually configurable (custom) or automatic triggering in full compliance/conformity with AFD (SMPTE 2016), VI (RP186), and WSS triggering. (ARC/AFD settings available only on UDX processing path.)

GPIO/COMM

(2) GPI configurable to select input routing. (2) GPO configurable to invoke upon input selected. RS-232/485 comm port. All connections via rear module RJ-45 GPIO/COMM jack.

Frame Reference Input

(2) reference from frame bus or selected program video ref sources. SMPTE 170M/318M "Black Burst", SMPTE 274M/296M "Tri-Level".
 Return Loss: >35 dB up to 5.75 MHz

ORDERING INFORMATION

9902-UDX-FS 3G/HD/SD-SDI Dual-Channel – Path 1 UDX / Path 2 Frame Sync with Audio Embed/De-Embed

RM20-9902-UDX-FS-A/S 20-Slot Frame Rear I/O Module (Split; supports 2 cards) (2) 3G/HD/SD-SDI Input BNC, (3) 3G/HD/SD-SDI Processed or Reclocked Output BNCs (connections are per each Card 1 / Card 2 connector bank)

RM20-9902-UDX-FS-C 20-Slot Frame Rear I/O Module (Standard Width) (4) 3G/HD/SD-SDI Input BNCs, (4) 3G/HD/SD-SDI Output BNCs, (1) 3G/HD/SDI Output BNC (with relay bypass failover), (1) GPIO/COMM RJ-45 connector

RM20-9902-UDX-FS-D-DIN 20-Slot Frame Rear I/O Module (Standard Width) (2) 3G/HD/SD-SDI Inputs, (1) CVBS Input, (8) AES Inputs, (2) Balanced Analog Audio Inputs, (2) 3G/HD/SD-SDI Outputs, (1) CVBS Processed Output, (8) AES Outputs, (2) Balanced Analog Audio Outputs (All coaxial connectors DIN1.0/2.3)

RM20-9902-UDX-FS-D-HDBNC 20-Slot Frame Rear I/O Module (Standard Width) (2) 3G/HD/SD-SDI Inputs, (1) CVBS Input, (8) AES Inputs, (2) Balanced Analog Audio Inputs, (2) 3G/HD/SD-SDI Outputs, (1) CVBS Processed Output, (8) AES Outputs, (2) Balanced Analog Audio Outputs (All coaxial connectors HD-BNC)

RM20-9902-UDX-FS-E-DIN 20-Slot Frame Rear I/O Module (Standard Width) (4) 3G/HD/SD-SDI Inputs, (8) AES Inputs, (4) 3G/HD/SD-SDI Outputs, (8) AES Outputs (All coaxial connectors DIN1.0/2.3)

RM20-9902-UDX-FS-E-HDBNC 20-Slot Frame Rear I/O Module (Standard Width) (4) 3G/HD/SD-SDI Inputs, (8) AES Inputs, (4) 3G/HD/SD-SDI Outputs, (8) AES Outputs (All coaxial connectors HD-BNC)ORD INFO

RM20-9902-UDX-FS-F 20-Slot Frame Rear I/O Module (Standard Width) (2) 3G/HD/SD-SDI Input BNCs, (1) 3G/HD/SD-SDI Processed Out BNC w/ Latching Input Select/Bypass, (3) 3G/HD/SD-SDI Output BNCs (GUI-selectable as Processed or Reclocked of selected input, (2) GPI, (2) GPO

RM20-9902-UDX-FS-H-DIN 20-Slot Frame Rear I/O Module (Standard Width) (3) 3G/HD/SD-SDI Inputs, (2) AES Inputs, (4) Balanced Analog Audio Inputs, (5) 3G/HD/SD-SDI Outputs, (2) AES Outputs, (4) Balanced Analog Audio Outputs, (1) Coaxial GPI/6 Hz, (1) Coaxial GPO w/ Isolated Return (All coaxial connectors DIN1.0/2.3.)

RM20-9902-UDX-FS-H-HDBNC 20-Slot Frame Rear I/O Module (Standard Width) (3) 3G/HD/SD-SDI Inputs, (2) AES Inputs, (4) Balanced Analog Audio Inputs, (5) 3G/HD/SD-SDI Outputs, (2) AES Outputs, (4) Balanced Analog Audio Outputs, (1) Coaxial GPI/6 Hz, (1) Coaxial GPO w/ Isolated Return (All coaxial connectors HD-BNC.)

RM20-9902-UDX-FS-J-DIN 20-Slot Frame Rear I/O Module (Standard Width) (2) 3G/HD/SD-SDI Inputs, (1) CVBS Input, (2) AES Inputs, (4) Balanced Analog Audio Inputs, (4) 3G/HD/SD-SDI Outputs, (1) CVBS Output, (2) AES Outputs, (4) Balanced Analog Audio Outputs, (1) Coaxial GPI/6 Hz, (1) Coaxial GPO w/ Isolated Return (All coaxial connectors DIN1.0/2.3.)

RM20-9902-UDX-FS-J-HDBNC 20-Slot Frame Rear I/O Module (Standard Width) (2) 3G/HD/SD-SDI Inputs, (1) CVBS Input, (2) AES Inputs, (4) Balanced Analog Audio Inputs, (4) 3G/HD/SD-SDI Outputs, (1) CVBS Output, (2) AES Outputs, (4) Balanced Analog Audio Outputs, (1) Coaxial GPI/6 Hz, (1) Coaxial GPO w/ Isolated Return (All coaxial connectors HD-BNC.)

RM20-9902-UDX-FS-K-DIN 20-Slot Frame Rear I/O Module (Standard Width) (4) 3G/HD/SD-SDI Inputs, (4) 3G/HD/SD-SDI Outputs (one 3G/HD/SDI Output with relay bypass failover), (6) AES Inputs, (2) Balanced Analog Audio Inputs, (4) AES Outputs, GPIO/COMM RJ-45 connector (All coaxial connectors DIN1.0/2.3)

RM20-9902-UDX-FS-K-HDBNC 20-Slot Frame Rear I/O Module (Standard Width) (4) 3G/HD/SD-SDI Inputs, (4) 3G/HD/SD-SDI Outputs (one 3G/HD/SDI Output with relay bypass failover), (6) AES Inputs, (2) Balanced Analog Audio Inputs, (4) AES Outputs, GPIO/COMM RJ-45 connector (All coaxial connectors HD-BNC)

9902-UDX-FS • 3G/HD/SD-SDI Dual-Channel – Path 1 UDX / Path 2 Frame Sync with Audio Embed/De-Embed

ORDERING INFORMATION (cont.)

RM20-9902-UDX-FS-L-DIN 20-Slot Frame Rear I/O Module (Standard-Width) (4) 3G/HD/SD-SDI Inputs, (1) CVBS Input, (8) 3G/HD/SD-SDI Outputs (1x2 DA output of each crosspoint out), (1) CVBS Output, COMM/GPIO RJ-45 connector, Ethernet Port (All coaxial connectors DIN1.0/2.3)

RM20-9902-UDX-FS-L-HDBNC 20-Slot Frame Rear I/O Module (Standard-Width) (4) 3G/HD/SD-SDI Inputs, (1) CVBS Input, (8) 3G/HD/SD-SDI Outputs (1x2 DA output of each crosspoint out), (1) CVBS Output, COMM/GPIO RJ-45 connector, Ethernet Port (All coaxial connectors HD-BNC)

RM20-9902-UDX-FS-M/S-DIN 20-Slot Frame Rear I/O Module (Split; supports 2 cards) (4) 3G/HD/SD-SDI Inputs, (6) 3G/HD/SD-SDI Outputs (Connections are per each Card 1 / Card 2 connector bank; all coaxial connectors DIN1.0/2.3)

RM20-9902-UDX-FS-M/S-HDBNC 20-Slot Frame Rear I/O Module (Split; supports 2 cards) (4) 3G/HD/SD-SDI Inputs, (6) 3G/HD/SD-SDI Outputs (Connections are per each Card 1 / Card 2 connector bank; all coaxial connectors HD-BNC)

RM20-9902-UDX-FS-N-DIN 20-Slot Frame Rear I/O Module (Double Width) (4) 3G/HD/SD-SDI Inputs, (1) CVBS Analog Video In, (8) AES Inputs, (4) Balanced Analog Audio Inputs, (8) 3G/HD/SD-SDI Outputs (1 with relay bypass protect), (1) CVBS Analog Video Out, (8) AES Outputs, (4) Balanced Analog Audio Outputs, (1) GPIO/COMM RJ-45 connector, 100/1000 BaseT Ethernet Port (All coaxial connectors DIN1.0/2.3.)

RM20-9902-UDX-FS-N-HDBNC 20-Slot Frame Rear I/O Module (Double Width) (4) 3G/HD/SD-SDI Inputs, (1) CVBS Analog Video In, (8) AES Inputs, (4) Balanced Analog Audio Inputs, (8) 3G/HD/SD-SDI Outputs (1 with relay bypass protect), (1) CVBS Analog Video Out, (8) AES Outputs, (4) Balanced Analog Audio Outputs, (1) GPIO/COMM RJ-45 connector, 100/1000 BaseT Ethernet Port (All coaxial connectors HD-BNC.)

RM20-9902-UDX-FS-P-DIN 20-Slot Frame Rear I/O Module (Standard-Width) (4) 3G/HD-SD-SDI Inputs (2 with independent relay bypass), (8) 3G/HD/SD-SDI Outputs (1x2 DA output of each crosspoint out), COMM/GPIO RJ-45 connector, Ethernet Port (All coaxial connectors DIN1.0/2.3)

RM20-9902-UDX-FS-P-HDBNC 20-Slot Frame Rear I/O Module (Standard-Width) (4) 3G/HD-SD-SDI Inputs (2 with independent relay bypass), (8) 3G/HD/SD-SDI Outputs (1x2 DA output of each crosspoint out), COMM/GPIO RJ-45 connector, Ethernet Port (All coaxial connectors HD-BNC)

Options:

+ANC Ancillary Data Processor Option

+COLOR Color Correction Option

+LTC Audio LTC I/O Option

+QC Quality Check Option

+CQS Clean & Quiet Switching Option

+UDX-FS-to-2UDX Add Path 2 UDX Option

+TTS Text-To-Speech Option (Acapela Text-To-Speech from Acapela Group™. Applicable only for Path 2 (frame sync) path. Installation requires option upload and installation of speech library SD memory card onto host card. Pre-loaded SD card and instructions provided.)

+2L-SPAN Add Spanish-language upgrade (add-on to option +TTS; option +TTS required)

+DLY Extended Frame Sync Delay Option

+SCTE104 SCTE 104 Insertion Option

+SCTE104-FAST Frame-Accurate SCTE 104 Trigger Insertion Option