

9903-UDX-ADDA • 3G/HD/SD-SDI Universal Format Converter with CVBS/YpBPr Video I/O, Up/Down/Cross Conversion, Frame Sync, AES and Analog Audio Embedding / De-Embedding

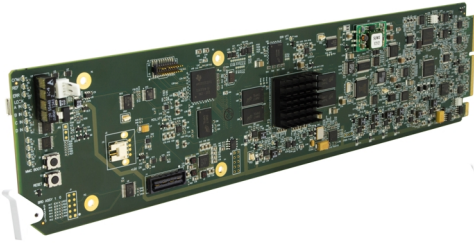

The Cobalt® 9903-UDX-ADDA 3G/HD/SD-SDI Universal Format Converter with CVBS/YpBPr Video I/O, Up/Down/Cross Conversion, Frame Sync, AES and Analog Audio Embedding / De-Embedding provides a high-density card-based solution that offers unprecedented multi-input support, flexibility, and ease of use and integration for SDI and analog video and discrete audio. Frame sync provides glitch-free audio upon frame sync events, with video/audio offsets user configurable. Audio embed adaptive SRC allows asynchronous 48 kHz AES audio to automatically sync with program video 48 kHz timing for glitch-free embedding. Individual, per-pair SRC auto-detects and disables SRC when a Dolby pair is detected on an input pair.

With option +ANC, the 9903-UDX-ADDA offers full VANC/HANC ancillary data packet de-embedding and embedding for 3G/HD/SD-SDI streams. The easy to use interface allows direct access to DID and SDID locations to extract or insert user data such as camera PTZ, SCTE 104, closed-captioning read/insert, GPI/GPO via ANC, or other specialized user payloads. Data can be extracted and inserted within the card, bypassing the scaler (Bridge mode), or inserted and/or extracted to and from external interface via serial or IP interfaces.

Multiple SDI input ports allow selection from multiple input sources with failover. Both CVBS and component analog

video is supported both as inputs and outputs.

The up/down/cross convert scaler is specifically designed for broadcast video formats, with full ARC control suitable for conversions to or from 4:3 and 16:9 aspect ratios. Timecode can be received and prioritized among any standard SMPTE embedded or audio LTC timecode.

Preset save/load allows saving custom card settings while allowing one-button revert to factory settings. Layered presets allow invoking changes related only to a specific area of concern (audio routing, for example) while not changing any other processing settings or aspects. Full user DashBoard™ or Remote Control Panel remote control allows full status and control access locally or across a standard Ethernet network. GPIO allows direct input routing control and status monitoring.

FEATURES

Multi-input, with failover switching

Universal I/O support – analog CVBS and component inputs and outputs, as well as analog and AES audio embed/de-embed. 10-bit processing with 5-line adaptive comb filtered SD Y/C separation.

Frame Sync with full H/V offset and manual/LOS video pattern generator

Up/Down/Cross Conversion with user and AFD, VI, and WSS ARC specifically tailored for broadcast video

Timecode processing can prioritize, filter for, and convert between specific SMPTE embedded-video or audio LTC

Full audio crosspoint with delay control and 5.1-to-stereo downmix available for all audio outputs

Option +ANC adds full user VANC/HANC packet insertion/extraction access to DID/SDID ancillary data such as camera PTZ, SCTE 104, closed captioning, and other specialized user payloads. Multi-mode setup includes Bridge mode (card internal path with scaler bypass bridging) or Insert/Extract modes for insert/extract to or from IP/serial external interfaces.

Available color correction option

Low-power/high-density design – less than 13 Watts per card

Remote control/monitoring via Dashboard™ software or OGCP-9000 remote control panels

Five year warranty

OPTIONS

Audio LTC I/O (+LTC)

Ancillary Data Processor (+ANC) – Provides full user VANC/HANC packet insertion/extraction access to DID/SDID ancillary data, with insert/extract to and from IP, RS-232/RS-422 serial, and GPIO external interfaces. Bridge mode can be set to preserve special/custom ANC packages when card scaler is enabled.

Color Correction (+COLOR) – Full RGB color corrector (offset, gain, gamma) with extended YCbCr proc controls with white hard clip, white soft clip, black hard clip, and saturation clip

SCTE 104 Insertion Option (+SCTE104) - Provides generation/insertion of SCTE 104 data into baseband SDI. Message send can be triggered from automation GPI or other modes. Full control of splice start, end, and cancel as well as pre-roll offsets.

SCTE104 Frame-Accurate SCTE Trigger Insertion Option (+SCTE104-FAST) - Uses Time Stamp data derived from broadcast automation to provide deterministic, frame-accurate Digital Program Insertion (DPI) message embedding into SDI. The linear channel is output with precise metadata marking the beginning and ending of each program and commercial segment, optimizing it for automatic dissemination to CDN and VOD systems.



9903-UDX-ADDA • 3G/HD/SD-SDI Universal Format Converter with CVBS/YPbPr Video I/O, Up/Down/Cross Conversion, Frame Sync, AES and Analog Audio Embedding / De-Embedding

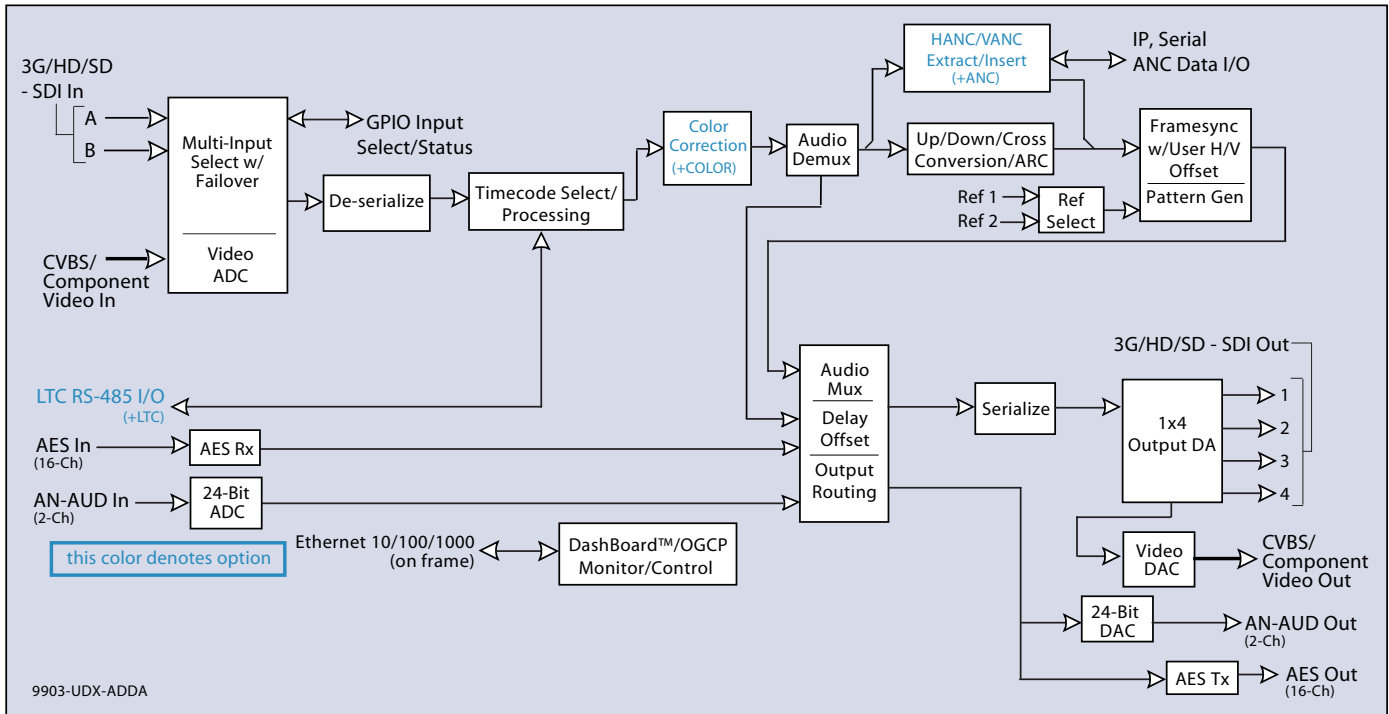

9903-UDX-ADDA

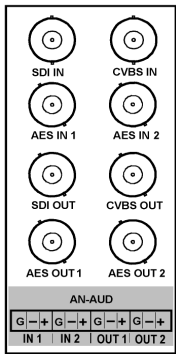

RM20-9903-B

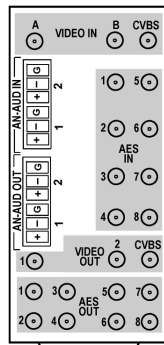

RM20-9903-D-DIN
RM20-9903-D-HDBNC

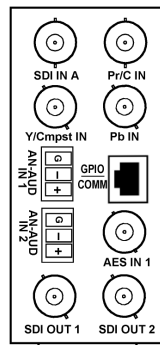

RM20-9903-E

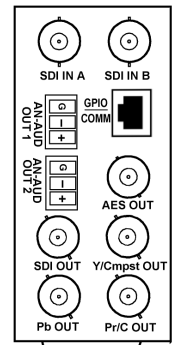

RM20-9903-F

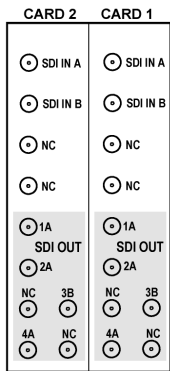

RM20-9903-GIS-DIN
RM20-9903-GIS-HDBNC

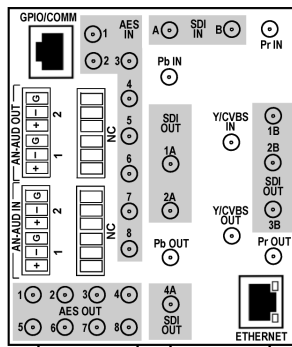

RM20-9903-H-DIN
RM20-9903-H-HDBNC

9903-UDX-ADDA • 3G/HD/SD-SDI Universal Format Converter with CVBS/YPbPr Video I/O, Up/Down/ Cross Conversion, Frame Sync, AES and Analog Audio Embedding / De-Embedding

SPECIFICATIONS

Note: Inputs/outputs are a function in some cases of rear I/O module used.

Power

< 13 Watts

SDI Input/Outputs

Up to (2) 75Ω BNC inputs

Up to (4) 75Ω BNC outputs

SDI Formats Supported: SMPTE 259M, SMPTE 292M, SMPTE 424M

SDI Receive Cable Length: 3G/HD/SD: 120/180/320 m (Belden 1694A)

SDI Return Loss: >15 dB up to 1.485 GHz; >10 dB up to 2.970 GHz

SDI Alignment Jitter: 3G/HD/SD: < 0.3/0.2/0.2 UI

Timing Jitter: 3G/HD/SD: < 2.0/1.0/0.2 UI

Note: SDI Return loss and receive cable length are affected by rear I/O module used. Specifications represent typical performance.

Analog Video Input/Outputs

(1) 75Ω BNC CVBS input

(1) 75Ω BNC CVBS output. CVBS can be upscaled to any supported SDI format; all SDI formats can be downconverted to CVBS.

(3) 75Ω BNC Component Video inputs (Y, Cb, Cr)

(3) 75Ω BNC Component Video outputs (Y, Cb, Cr)

ADC resolution: 10-bit

Sampling frequency: 54 MHz (4x over-sampling SD)

SD Y/C separation: 5-line Adaptive Comb Filter

SD Freq. Response: ± 0.25 dB to 5.5 MHz

SD SNR: > 55 dB to 5.5 MHz (unweighted)

Differential Phase: < 1 degree

Differential Gain: < 1%

Nonlinearity < 1%

HD Freq. Response: Y 30 MHz., PbPr 15 MHz

HD SNR: > 55 dB to 30 MHz (unweighted)

Discrete Audio Input/Outputs

(8) AES-3id 75Ω BNC input

(8) AES-3id 75Ω BNC output

(2) Balanced analog audio inputs

(2) Balanced analog audio outputs

I/O conforms to 0 dBFS = +24 dBu

Analog Input Impedance: >10 kΩ

Analog Reference Level: -20 dBFS

Analog Nominal Level: +4 dBu

Analog Input Clip Level: +24 dBu (0 dBFS)

Analog Freq. Response: ±0.2 dB (20 Hz to 20 kHz)

Analog SNR: 115 dB (A weighted)

Analog THD+N: -96 dB (20 Hz to 10 kHz)

Analog Crosstalk: -106 dB (20 Hz to 20 kHz)

ARC

ARC manually configurable (custom) or automatic triggering in full compliance/conformity with AFD (SMPTE 2016), VI (RP186), and WSS triggering.

GPIO/COMM

(2) GPI configurable to select input routing. (2) GPO configurable to invoke upon input selected. RS-232/485 comm port. All connections via rear module RJ-45 GPIO/COMM jack.

Frame Reference Input

(2) reference from frame bus. SMPTE 170M/318M "Black Burst", SMPTE 274M/296M "Tri-Level".

Return Loss: >35 dB up to 5.75 MHz

9903-UDX-ADDA • 3G/HD/SD-SDI Universal Format Converter with CVBS/YPbPr Video I/O, Up/Down/Cross Conversion, Frame Sync, AES and Analog Audio Embedding / De-Embedding

ORDERING INFORMATION

9903-UDX-ADDA 3G/HD/SD-SDI Universal Format Converter with CVBS/YPbPr Video I/O, Up/Down/Cross Conversion, Frame Sync, AES and Analog Audio Embedding / De-Embedding

RM20-9903-B 20-Slot Frame Rear I/O Module (Standard Width) (1) 3G/HD/SD-SDI Input BNC, (1) CVBS Input BNC, (2) Balanced Analog Audio Inputs, (2) AES Input BNCs, (1) 3G/HD/SD-SDI Output BNC, (1) CVBS Video Out BNC, (2) Balanced Analog Audio Outputs, (2) AES Output BNCs

RM20-9903-D-DIN 20-Slot Frame Rear I/O Module (Standard Width) (2) 3G/HD/SD-SDI Inputs, (1) CVBS Input, (8) AES Inputs, (2) Balanced Analog Audio Inputs, (2) 3G/HD/SD-SDI Outputs, (1) CVBS Processed Output, (8) AES Outputs, (2) Balanced Analog Audio Outputs (All coaxial connectors DIN1.0/2.3)

RM20-9903-D-HDBNC 20-Slot Frame Rear I/O Module (Standard Width) (2) 3G/HD/SD-SDI Inputs, (1) CVBS Input, (8) AES Inputs, (2) Balanced Analog Audio Inputs, (2) 3G/HD/SD-SDI Outputs, (1) CVBS Processed Output, (8) AES Outputs, (2) Balanced Analog Audio Outputs (All coaxial connectors HD-BNC)

RM20-9903-E 20-Slot Frame Rear I/O Module (Standard Width) (1) 3G/HD/SD-SDI Input BNC, Component/CVBS Video In BNCs, (1) AES In BNC, (2) Balanced Analog Audio Inputs, (2) 3G/HD/SD-SDI Output BNCs, (1) GPIO/COMM RJ-45 connector

RM20-9903-F 20-Slot Frame Rear I/O Module (Standard Width) (2) 3G/HD/SD-SDI Input BNCs, Component/CVBS Video Out BNCs, (1) AES Out BNC, (2) Balanced Analog Audio Outputs, (1) 3G/HD/SD-SDI Output BNC, (1) GPIO/COMM RJ-45 connector

RM20-9903-G/S-DIN 20-Slot Frame Rear I/O Module (Split; supports 2 cards) (2) 3G/HD/SD-SDI Inputs, (4) 3G/HD/SD-SDI Outputs (Connections are per each Card 1 / Card 2 connector bank; all coaxial connectors DIN1.0/2.3)

RM20-9903-G/S-HDBNC 20-Slot Frame Rear I/O Module (Split; supports 2 cards) (2) 3G/HD/SD-SDI Inputs, (4) 3G/HD/SD-SDI Outputs (Connections are per each Card 1 / Card 2 connector bank; all coaxial connectors HD-BNC)

RM20-9903-H-DIN 20-Slot Frame Rear I/O Module (Double Width) (2) 3G/HD/SD-SDI Inputs, (1) Component/CVBS Video In, (8) AES Inputs, (2) Balanced Analog Audio Inputs, (6) 3G/HD/SD-SDI Outputs, (1) Component/CVBS Video Out, (8) AES Outputs, (2) Balanced Analog Audio Outputs, (1) GPIO/COMM RJ-45 connector, 100/1000 BaseT Ethernet Port (All coaxial connectors DIN1.0/2.3)

RM20-9903-H-HDBNC 20-Slot Frame Rear I/O Module (Double Width) (2) 3G/HD/SD-SDI Inputs, (1) Component/CVBS Video In, (8) AES Inputs, (2) Balanced Analog Audio Inputs, (6) 3G/HD/SD-SDI Outputs, (1) Component/CVBS Video Out, (8) AES Outputs, (2) Balanced Analog Audio Outputs, (1) GPIO/COMM RJ-45 connector, 100/1000 BaseT Ethernet Port (All coaxial connectors HD-BNC)

+**LTC** Audio LTC I/O Option

+**COLOR** Color Correction Option

+**ANC** Ancillary Data Processor

+**SCTE104** SCTE 104 Insertion Option

+**SCTE104-FAST** Frame-Accurate SCTE 104 Trigger Insertion Option